

TLS-450 To TLS-450PLUS Console

Upgrade Instructions

Notice

Veeder-Root makes no warranty of any kind with regard to this publication, including, but not limited to, the implied warranties of merchantability and fitness for a particular purpose.

Veeder-Root shall not be liable for errors contained herein or for incidental or consequential damages in connection with the furnishing, performance, or use of this publication.

Veeder-Root reserves the right to change system options or features, or the information contained in this publication.

This publication contains proprietary information which is protected by copyright. All rights reserved. No part of this publication may be photocopied, reproduced, or translated to another language without the prior written consent of Veeder-Root.

Contact TLS Systems Technical Support for additional troubleshooting information at 800-323-1799.

DAMAGE CLAIMS / LOST EQUIPMENT

Thoroughly examine all components and units as soon as they are received. If any cartons are damaged or missing, write a complete and detailed description of the damage or shortage on the face of the freight bill. The carrier's agent must verify the inspection and sign the description. Refuse only the damaged product, not the entire shipment.

Veeder-Root must be notified of any damages and/or shortages within 30 days of receipt of the shipment, as stated in our Terms and Conditions.

VEEDER-ROOT'S PREFERRED CARRIER

1. Contact Veeder-Root Customer Service at 800-873-3313 with the specific part numbers and quantities that were missing or received damaged.
2. Fax signed Bill of Lading (BOL) to Veeder-Root Customer Service at 800-234-5350.
3. Veeder-Root will file the claim with the carrier and replace the damaged/missing product at no charge to the customer. Customer Service will work with production facility to have the replacement product shipped as soon as possible.

CUSTOMER'S PREFERRED CARRIER

1. It is the customer's responsibility to file a claim with their carrier.
2. Customer may submit a replacement purchase order. Customer is responsible for all charges and freight associated with replacement order. Customer Service will work with production facility to have the replacement product shipped as soon as possible.
3. If "lost" equipment is delivered at a later date and is not needed, Veeder-Root will allow a Return to Stock without a restocking fee.
4. Veeder-Root will NOT be responsible for any compensation when a customer chooses their own carrier.

RETURN SHIPPING

For the parts return procedure, please follow the appropriate instructions in the "General Returned Goods Policy" pages in the "Policies and Literature" section of the Veeder-Root **North American Environmental Products** price list. Veeder-Root will not accept any return product without a Return Goods Authorization (RGA) number clearly printed on the outside of the package.

Introduction

Contractor Certification Requirements 1
 Safety Precautions 1
 Safety Warnings 2
 Related Documents 2
 Documents Required to Install Equipment 2
 Reference Manuals 2

Perform A Database Backup

Precautions Against Static Electricity 3
 Before Turning Off Power 3

Preparing The TLS-450 Console For Upgrade

Removing The Display Door 6
 Removing The CPU Board 10
 Comm Module Upgrades 12
 Installing New TLS-450PLUS CPU Board 14
 Installing New TLS-450PLUS Display Door 16

Initializing The TLS-450PLUS Console After The Upgrade 20

Figures

Figure 1. USB/Ethernet Board - V-R Thumbdrive Port 3
 Figure 2. Accessing Diagnostic Main Screen From The Home Screen 4
 Figure 3. Software Maintenance Button 4
 Figure 4. Initiating A System Backup 5
 Figure 5. Opening The TLS-450 Console Doors 6
 Figure 6. Removing Optional Printer Cable 7
 Figure 7. Removing The Three Display Panel Cables 8
 Figure 8. Disconnect The Ground Wire From The Display Door 9
 Figure 8. Locating CPU Board Retention Snap-Pins 10
 Figure 9. Locating TLS-450 CPU Board Reusable iButton 11
 Figure 10. Removing Comm Module Clamp 12
 Figure 11. Install Ethernet Module In Slot 4 12
 Figure 12. Install USB/Wireless Module In Slot 5 13
 Figure 13. Replace Comm Module Clamp And Securing Screw 13
 Figure 14. Insert iButton In Socket On New TLS-450PLUS CPU Board 14
 Figure 15. Install iButton Flange Facing Up 14
 Figure 16. Remove TLS-450PLUS CPU Board Battery Isolator Strip 14
 Figure 17. Connect Ethernet Cables 15
 Figure 18. Connect Wireless Cable 15
 Figure 19. Connect USB Module Cables 16
 Figure 20. Connect Optional Printer USB Cable 16
 Figure 21. Install The New TLS-450PLUS Display Door 17
 Figure 22. Connect The Ground Cable 17
 Figure 23. Connect Data Display And LED Backlight Cables To CPU Board 18
 Figure 24. Locating SD Card On CPU Board 18
 Figure 25. Installing SD Card 19

Introduction

This manual contains procedures for a TLS-450 to TLS-450PLUS console upgrade. The instructions herein assume all site monitoring devices have been previously installed and site wiring is complete.

Contractor Certification Requirements

Veeder-Root requires the following minimum training certifications for contractors who will install and setup the equipment discussed in this manual:

Installer Certification (Level 1): Contractors holding valid Installer Certification are approved to perform wiring and conduit routing; equipment mounting; probe, sensor and carbon canister vapor polisher installation; wireless equipment installation; tank and line preparation; and line leak detector installation.









Technician Certification (Level 2/3): Contractors holding valid Technician Certifications are approved to perform installation checkout, startup, programming and operations training, system tests, troubleshooting and servicing for all Veeder-Root Series Tank Monitoring Systems, including Line Leak Detection. In addition, Contractors with the following sub-certification designations are approved to perform installation checkout, startup, programming, system tests, troubleshooting, service techniques and operations training on the designated system.

- Wireless 2
- Tall Tank

Warranty Registrations may only be submitted by selected Distributors.

Safety Precautions

The following safety symbols may be used throughout this manual to alert you to important safety hazards and precautions

 <p>EXPLOSIVE Fuels and their vapors are extremely explosive if ignited.</p>	 <p>FLAMMABLE Fuels and their vapors are extremely flammable.</p>
 <p>ELECTRICITY High voltage exists in, and is supplied to, the device. A potential shock hazard exists.</p>	 <p>TURN POWER OFF Live power to a device creates a potential shock hazard. Turn Off power to the device and associated accessories when servicing the unit.</p>
 <p>WARNING Heed the adjacent instructions to avoid damage to equipment, property, environment or personal injury.</p>	 <p>READ ALL RELATED MANUALS Knowledge of all related procedures before you begin work is important. Read and understand all manuals thoroughly. If you do not understand a procedure, ask someone who does.</p>
 <p>USE SAFETY BARRICADES Unauthorized people in the work area are dangerous. Always use safety cones or safety tape to block access to the work area.</p>	 <p>STATIC SENSITIVE COMPONENTS Wear grounded anti-static wrist strap before handling the printed circuit board and mounted components.</p>

Safety Warnings

⚠ WARNING	
	<p>This console contains high voltages which can be lethal. It is also connected to low power devices that must be kept intrinsically safe.</p> <p>FAILURE TO COMPLY WITH THE FOLLOWING WARNINGS AND SAFETY PRECAUTIONS COULD CAUSE DAMAGE TO PROPERTY, ENVIRONMENT, RESULTING IN SERIOUS INJURY OR DEATH.</p> <p>1. Turn off and tag and lockout power at the circuit breaker while performing this upgrade.</p>

Related Documents

DOCUMENTS REQUIRED TO INSTALL EQUIPMENT

This equipment must be installed according to the applicable installation document:

Equipment	ATEX Descriptive System	IECEX Descriptive System	UL/cUL Control Drawing
	Document No.	Document No.	Document No.
Associated Apparatus			
TLS-450PLUS	331940-006	331940-106	331940-008
Intrinsically Safe Apparatus for Wireless Applications			
Tank Gauge Accessories	331940-005	331940-105	331940-012

REFERENCE MANUALS

577014-073 TLS-450PLUS Console Site Prep And Installation Manual

Perform A Database Backup

Precautions Against Static Electricity

Before removing electronic components from their anti-static bags read the following static electricity precautions.

1. Before handling any components, discharge your body's static electric charge by touching a grounded surface.
2. Do not remove parts from their anti-static bags until you are ready to install them.
3. Do not lay parts on the anti-static bags! Only the insides are anti-static.
4. When handling parts, hold them by their edges and their metal mounting brackets.
5. Avoid touching components or edge connectors that plug into slots and wear the anti-static wrist strap (Part No. 576010-908) included in your component replacement kit.
6. Never slide parts over any surface.
7. Avoid plastic, vinyl, and Styrofoam in your work area.



Before Turning Off Power

Before powering off the console perform a system backup:

1. Insert the V-R Backup Thumbdrive (P/N 332970-004) in the external USB port on the USB/Ethernet card, P/N 332913-001 (see item 2 in Figure 1).

NOTE: You will need the V-R Backup Thumb drive with the system backup to perform a system restore once the hardware migration is completed. The migration will not be finalized until a system restore is performed as described on Page 20.

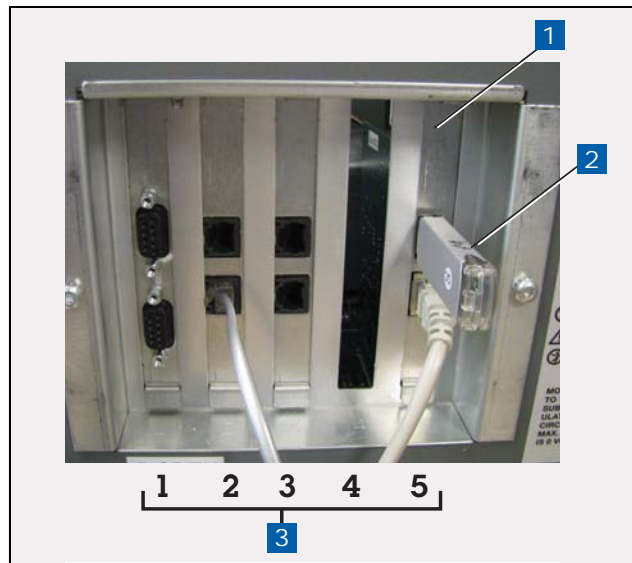

Figure 1. USB/Ethernet Board - V-R Thumbdrive Port

LEGEND FOR NUMBERED BOXES IN Figure 1

- | | |
|---|--|
| 1. USB/Ethernet board bracket | 3. Comm slot positions (left to right) |
| 2. V-R thumbdrive plugged into USB port | |

2. Touch the Diagnostics button on the Home Screen (see item 2 in Figure 2).

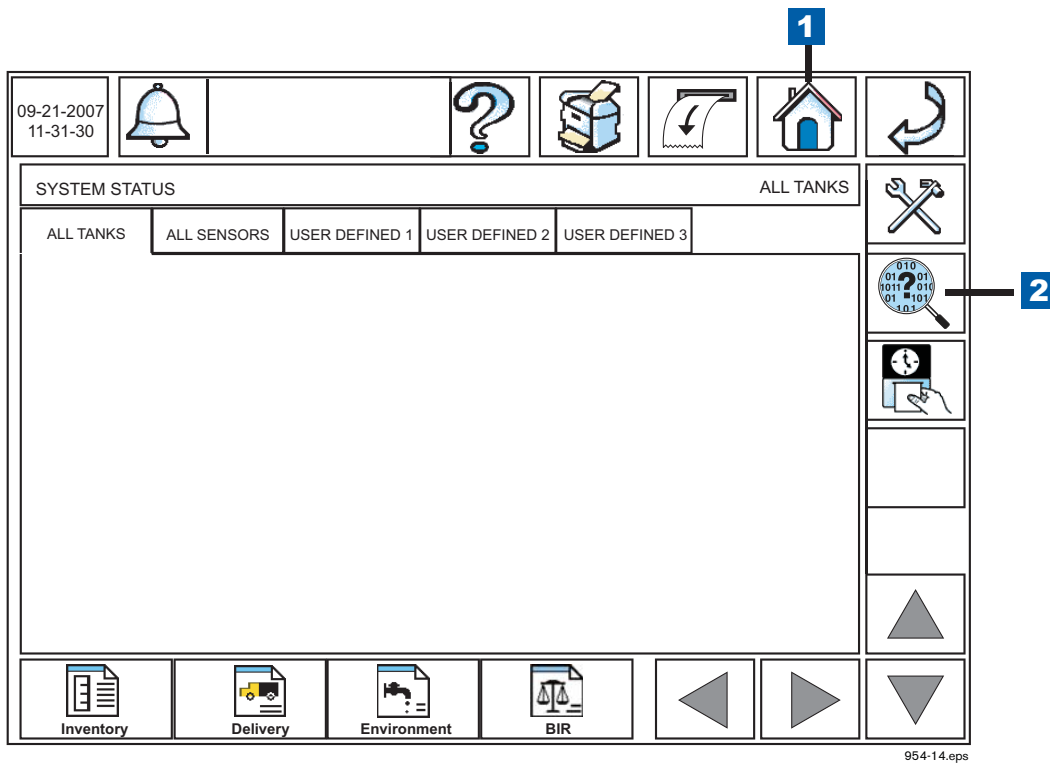

Figure 2. Accessing Diagnostic Main Screen From The Home Screen

LEGEND FOR NUMBERED BOX IN Figure 2	
1.	Home Screen access button
2.	Diagnostic Main Screen access button

3. Touch the Software Maintenance button on the Diagnostic Maintenance screen (see Figure 3) to open the Software Maintenance - Backup Restore tab screen (see Figure 4).



Figure 3. Software Maintenance Button

4. Touch the Backup button (item 1 in Figure 4) to begin the system backup process.

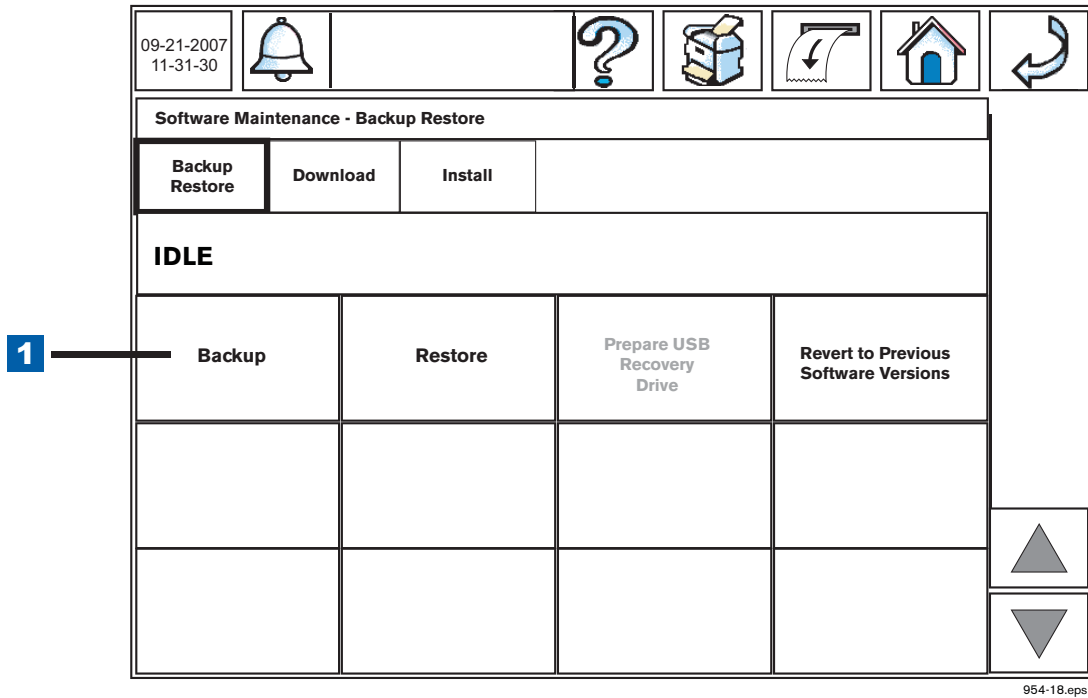

Figure 4. Initiating A System Backup

LEGEND FOR NUMBERED BOX IN Figure 4	
1.	Backup button

5. After the 'Backup Completed Successfully' message displays, you can safely remove the V-R Backup Thumbdrive.
6. Print out or write down TLS-450 Ethernet settings.
7. Print out or write down all remaining TLS-450 communication port settings.

Preparing The TLS-450 Console For Upgrade

Removing The Display Door



1. Turn off, tag and lockout the breaker that supplies power to the console.



2. Open both doors to the left (see Figure 5).

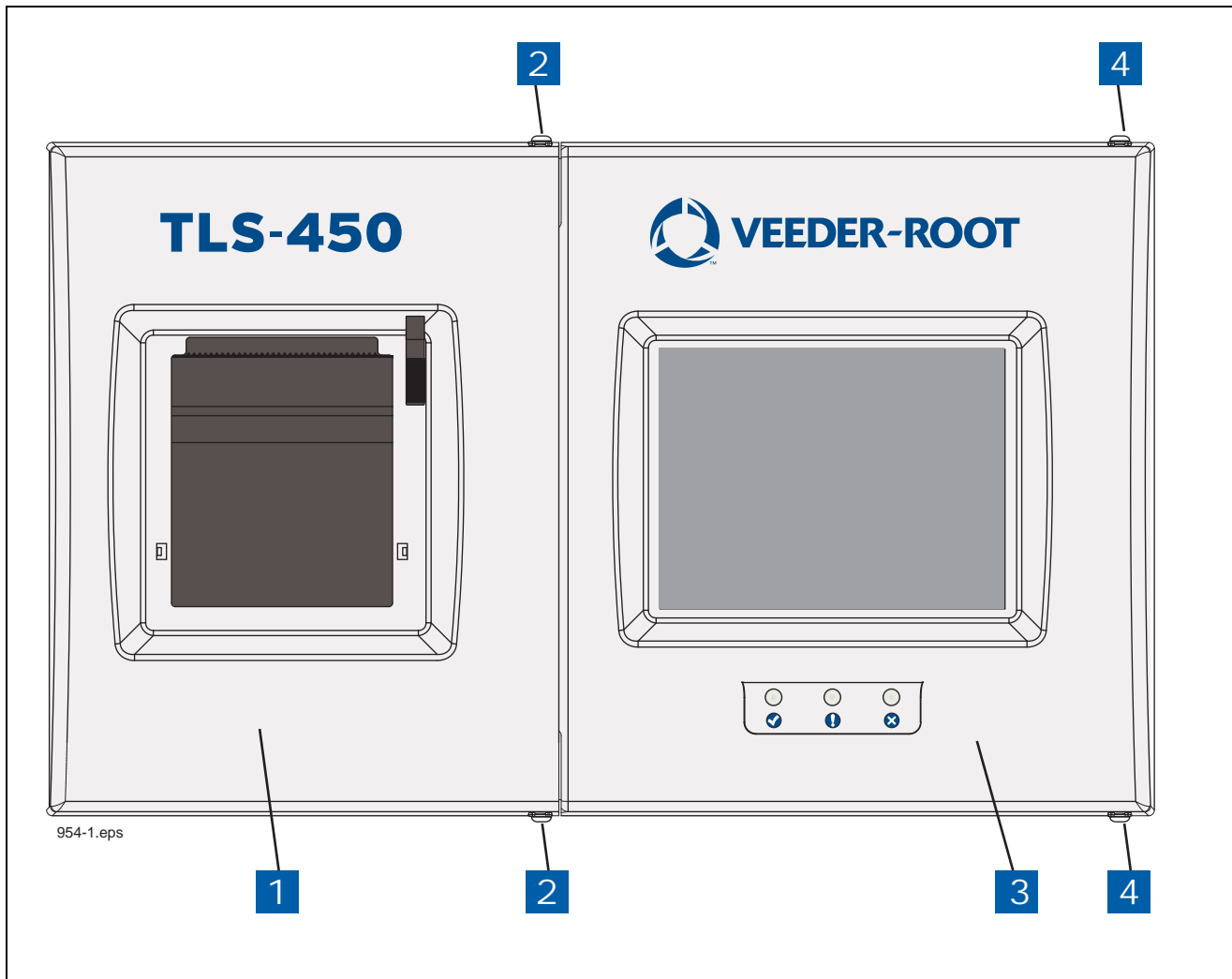

Figure 5. Opening The TLS-450 Console Doors

LEGEND FOR NUMBERED BOXES IN Figure 5

- | | |
|--|--|
| 1. Left (Printer) door | 3. Right (Display) door. |
| 2. Using a T-15 Torx driver, remove the top and bottom screws securing left door and swing door to left. | 4. Using a T-15 Torx driver, remove the top and bottom screws securing left door and swing door to left. |

3. If a printer is installed, unplug the printer USB cable from the CPU board connector (see Figure 6).

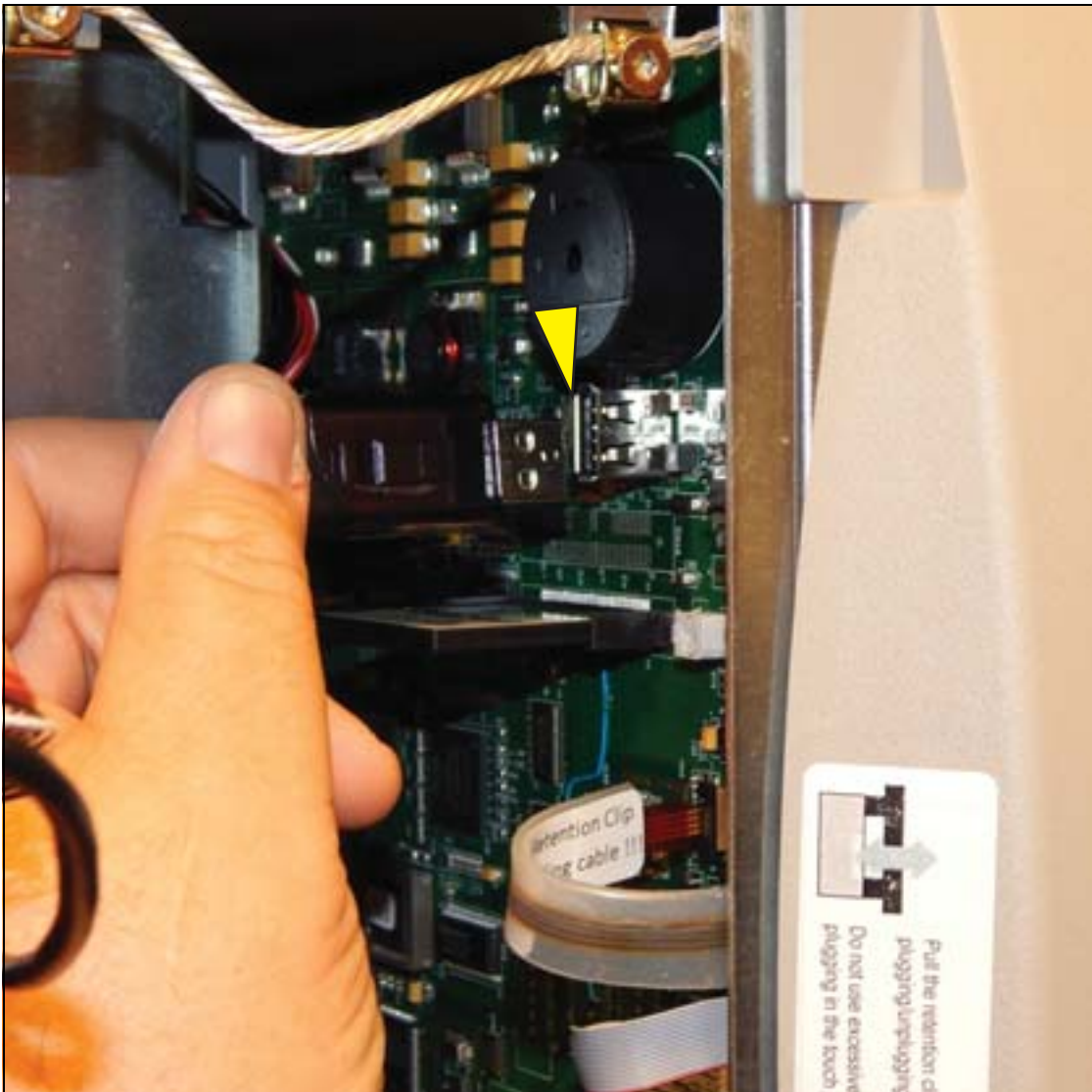

Figure 6. Removing Optional Printer Cable

4. Unplug the Display panel's Touchscreen control cable (3) Data cable (4), and LED backlight cable (5) connectors from the CPU board (see Figure 7).

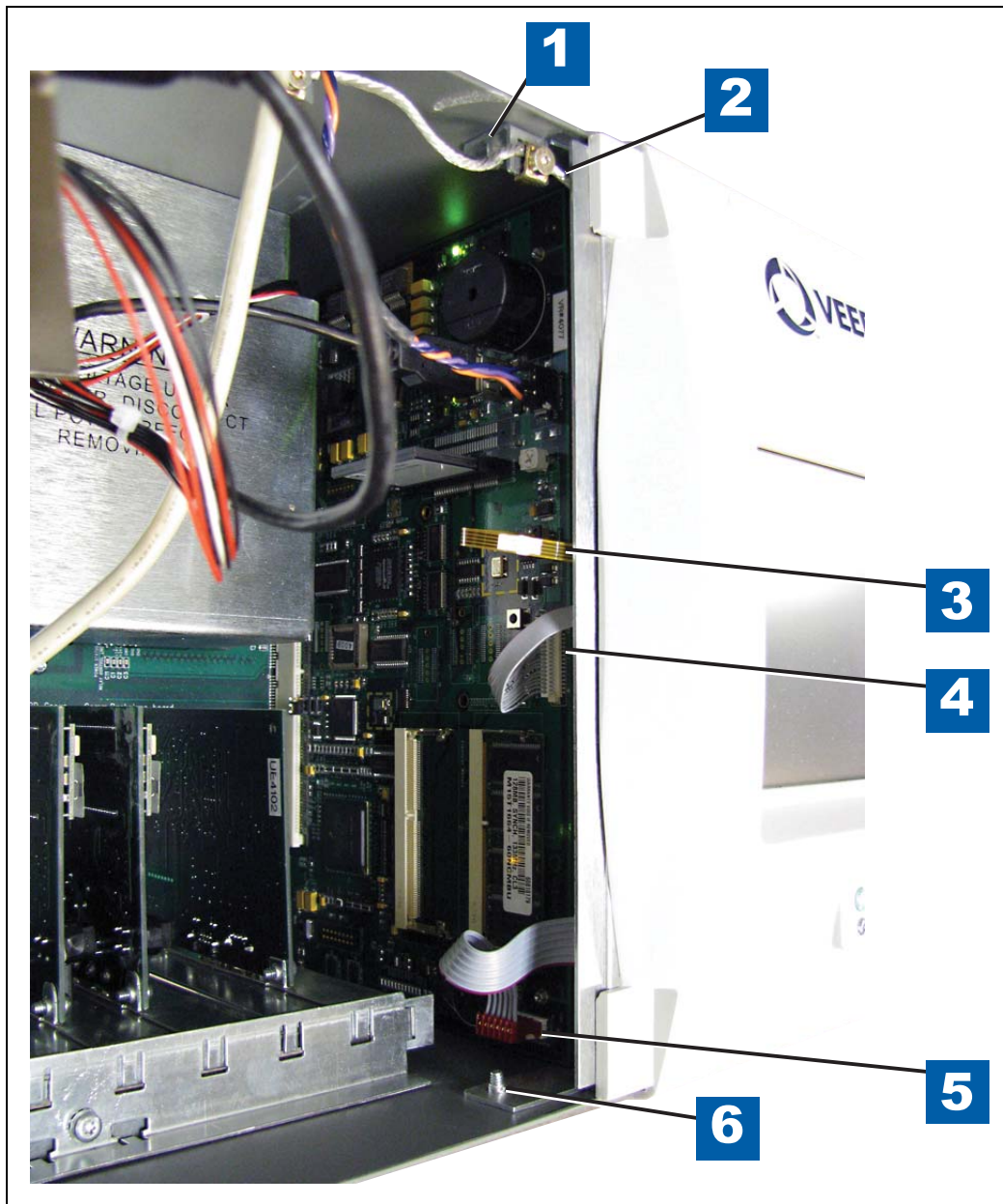

Figure 7. Removing The Three Display Panel Cables

LEGEND FOR NUMBERED BOXES IN Figure 7

- | | |
|--|---|
| 1. Top Display door hinge shoulder screw | 4. Display data cable |
| 2. Grounding wire | 5. LED/Display cable |
| 3. Touchscreen control cable | 6. Bottom Display door hinge shoulder screw |

5. Disconnect the ground wire from the Display door at the grounding clamp.

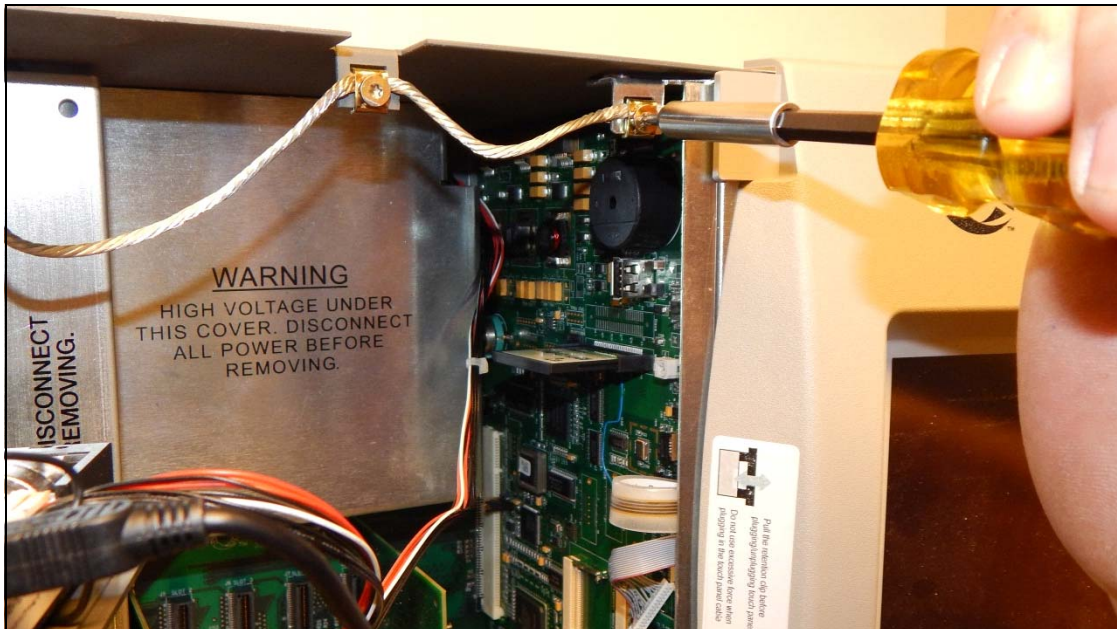

Figure 8. Disconnect The Ground Wire From The Display Door

6. Remove the top and bottom Display door hinge shoulder screws and remove the door (items 1 and 6 in Figure 7). Retain the two hinge shoulder screws for the TLS-450PLUS upgrade door.

Removing The CPU Board

1. Locate the three retention snap pins along the front of the CPU board (see Figure 8).

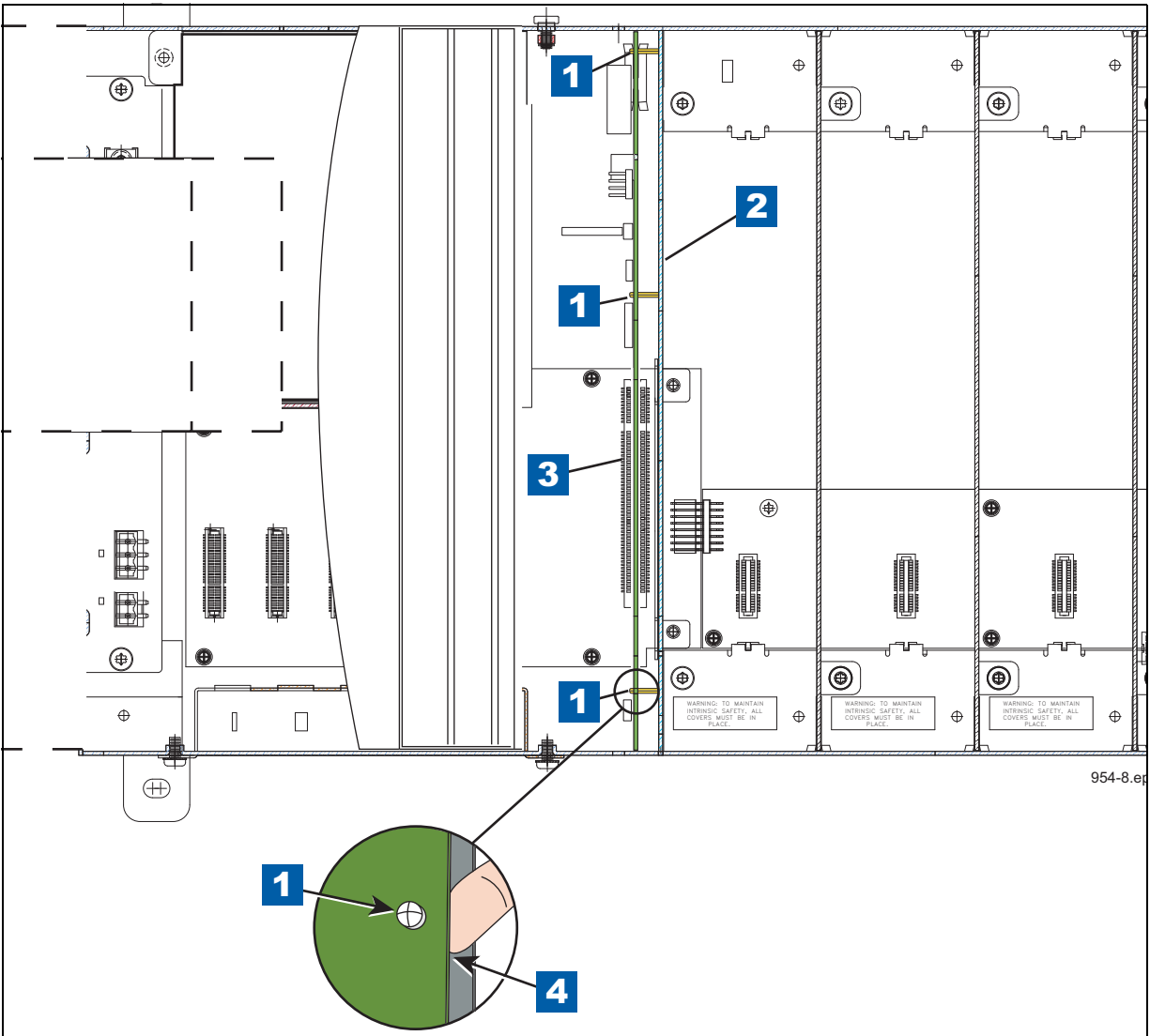

Figure 8. Locating CPU Board Retention Snap-Pins

LEGEND FOR NUMBERED BOXES IN Figure 8

- | | |
|-----------------------------------|--|
| 1. Board retention snap pins | 4. Use finger to pry board off snap pin. |
| 2. Compartment bulkhead. | |
| 3. CPU board backplane connector. | |

2. Remove the grounding wrist strap (Part No. 576010-908) from its package and wrap one end around your wrist. Adhere the other end to a metal surface on the inside of the console.
3. Position your forefinger beneath one of the pins and press up releasing the CPU board from the snap pin (see item 4 in Figure 8). Repeat at each of the remaining two retention pins.

4. Tilt the board a little away from the bulkhead (item 2 in Figure 8) and grasping the edge of the board pull out firmly to remove the board from its backplane board connector. Once the CPU board is free from the connector, slowly remove the board from the console being careful not to hit the CF card against the door.
5. Place the TLS-450 CPU board on a clean work surface. Locate the iButton on the TLS-450 CPU board. This component will be transferred to the new TLS-450PLUS CPU board.

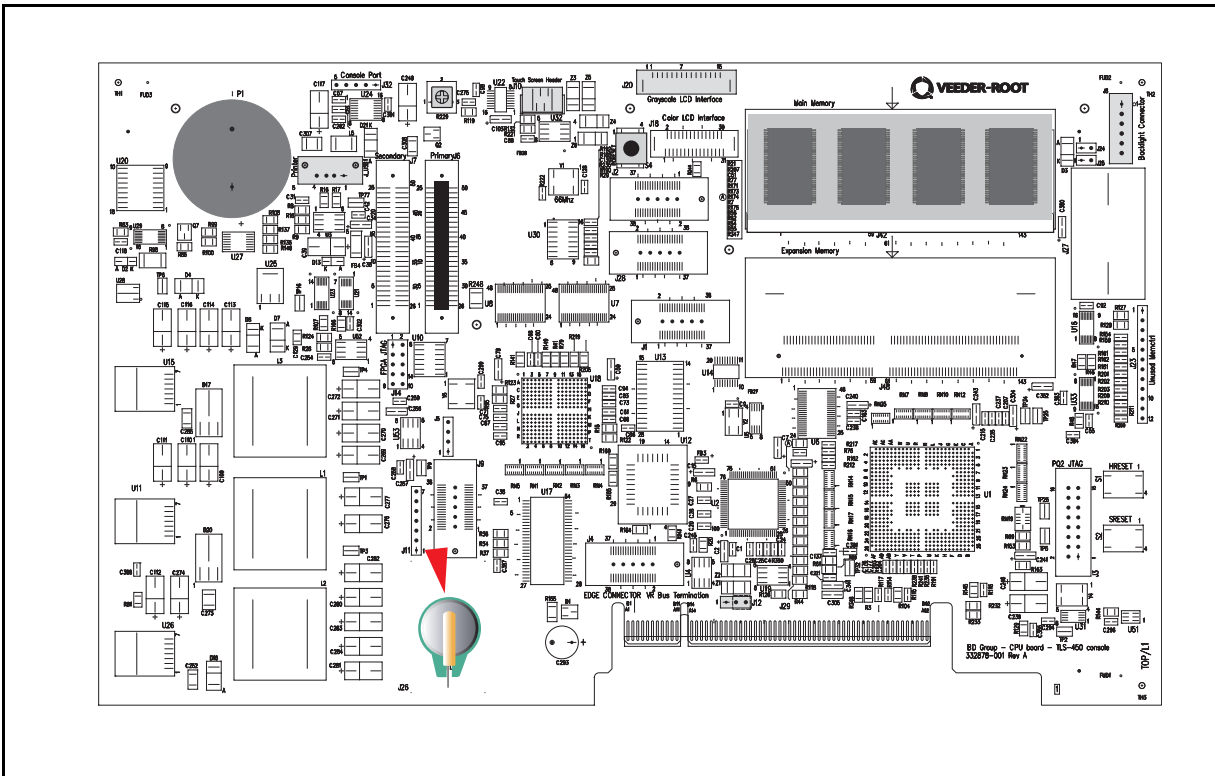

Figure 9. Locating TLS-450 CPU Board Reusable iButton

Comm Module Upgrades

1. Remove the module clamp securing screw and set aside clamp and screw (see Figure 10).



Figure 10. Removing Comm Module Clamp

LEGEND FOR NUMBERED BOXES IN Figure 9	
1. Comm module clamp	2. Clamp securing screw

2. Remove Comm boards from Comm Module Bay slots 4 and 5 (see Figure 1) and set aside.
3. Install the TLS-450PLUS Ethernet Interface module in slot 4 (see Figure 11).

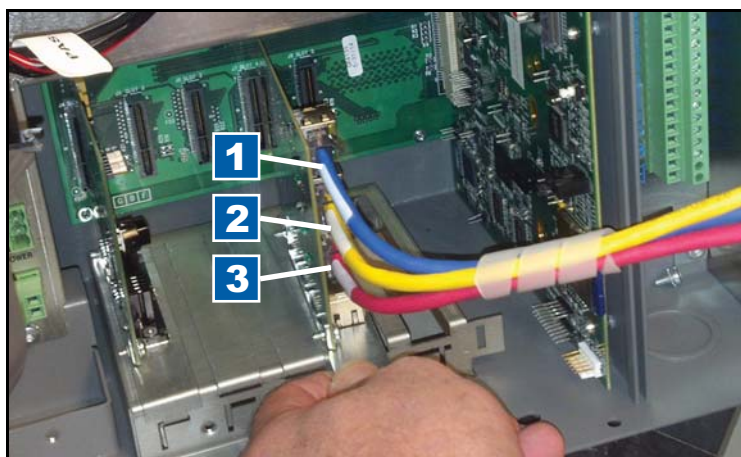

Figure 11. Install Ethernet Module In Slot 4

LEGEND FOR NUMBERED BOXES IN Figure 9	
1. Blue (E3)	3. Red (E1)
2. Yellow (E2)	

4. Install the TLS-450PLUS USB Module in slot 5 (see Figure 12).

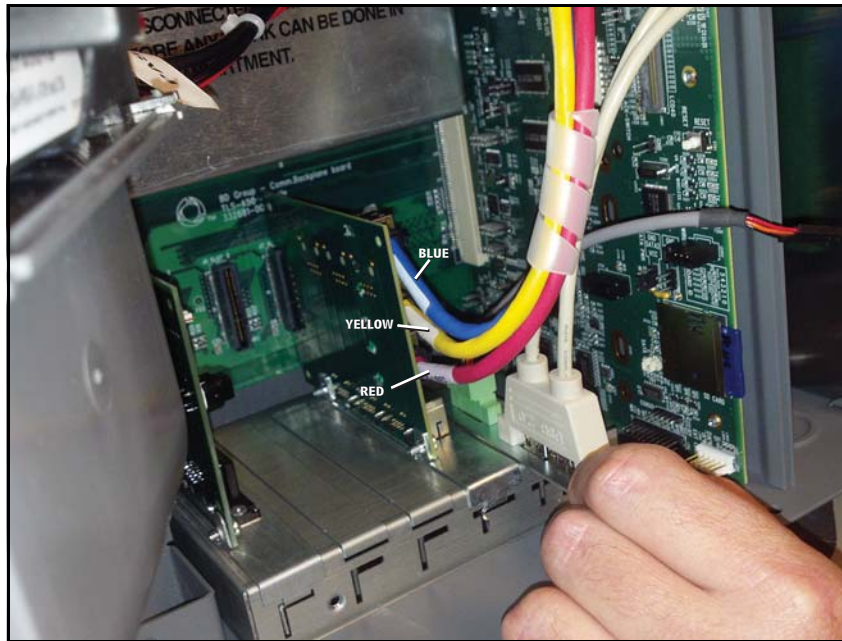

Figure 12. Install USB/Wireless Module In Slot 5

5. Relocate other Comm module(s) in available slot(s). If CDIM module was in slot 4 relocate it to slot 1 or 2. Replace Comm module clamp and securing screw (see Figure 13).

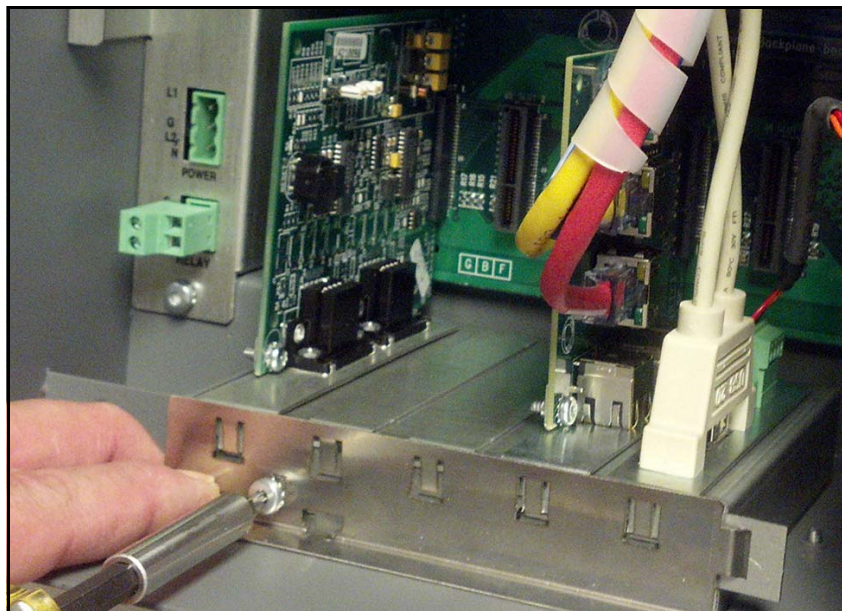

Figure 13. Replace Comm Module Clamp And Securing Screw

Installing New TLS-450PLUS CPU Board

1. With anti-static strap attached to wrist and to metal surface of TLS-450 console, remove the iButton from the TLS-450 CPU board and install it in the empty socket on the new TLS-450PLUS CPU board (see Figure 14). Make sure the flanged side of the iButton is facing up in its socket (see Figure 15).

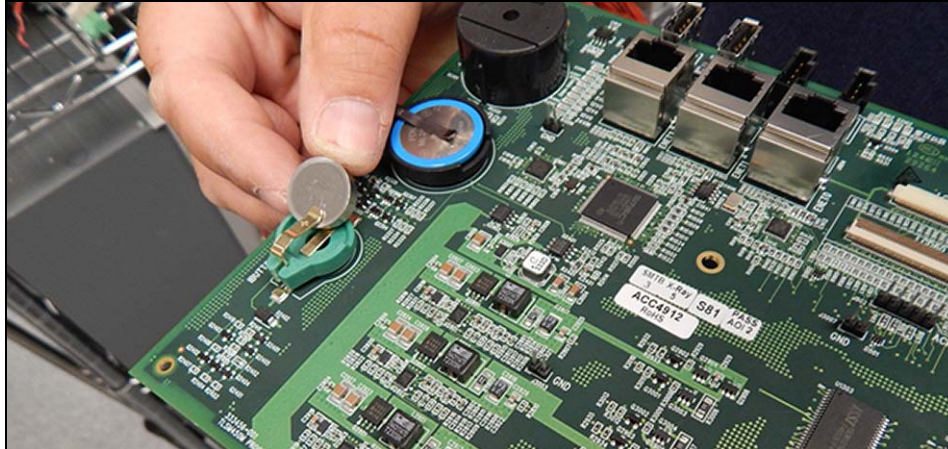

Figure 14. Insert iButton In Socket On New TLS-450PLUS CPU Board

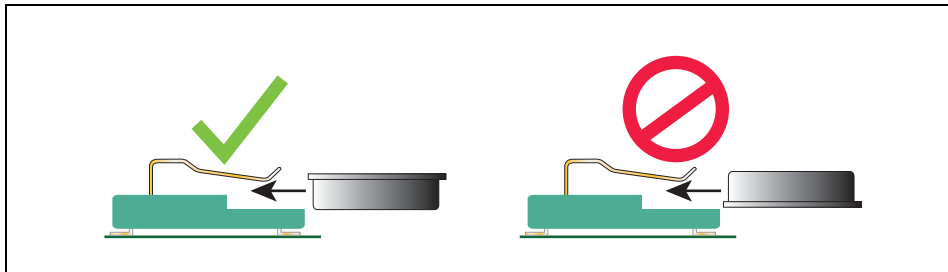

Figure 15. Install iButton Flange Facing Up

2. Install the new TLS-450PLUS CPU board into the console. Line up with slot in back of console wall and make sure board is fully seated in its backplane connector and the front edge is over the standoff pins (item 1 in Figure 8). Push board front edge onto snap pins to secure it in place.
3. Remove the battery isolator strip from under the battery hold-down clip (see Figure 16).

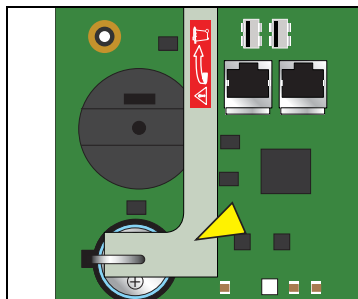

Figure 16. Remove TLS-450PLUS CPU Board Battery Isolator Strip

4. Reconnect the Ethernet Interface module's three cables to the CPU board's Ethernet connectors. Blue cable (E 3) to top connector, yellow (E 2) to next down and red (E 1) to lower connector - see Figure 17).

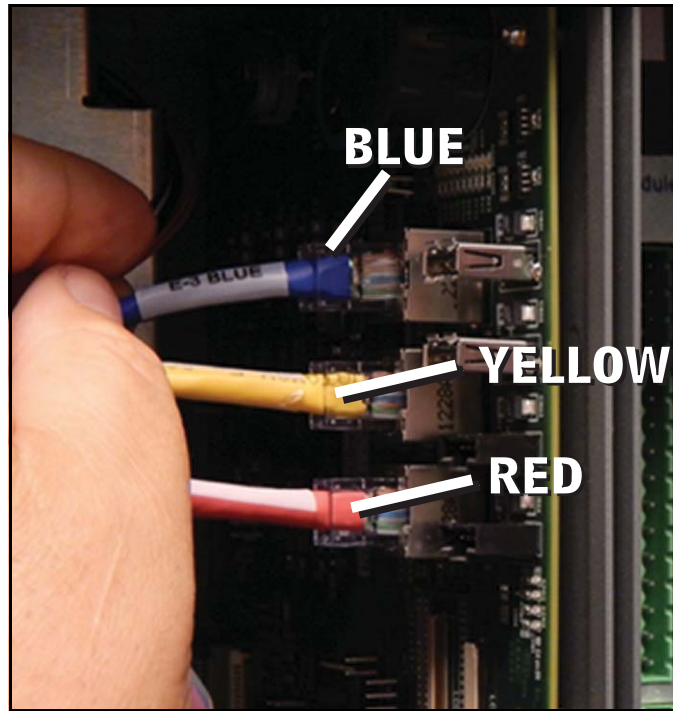

Figure 17. Connect Ethernet Cables

5. Connect the Wireless cable to the CPU board (see Figure 18).

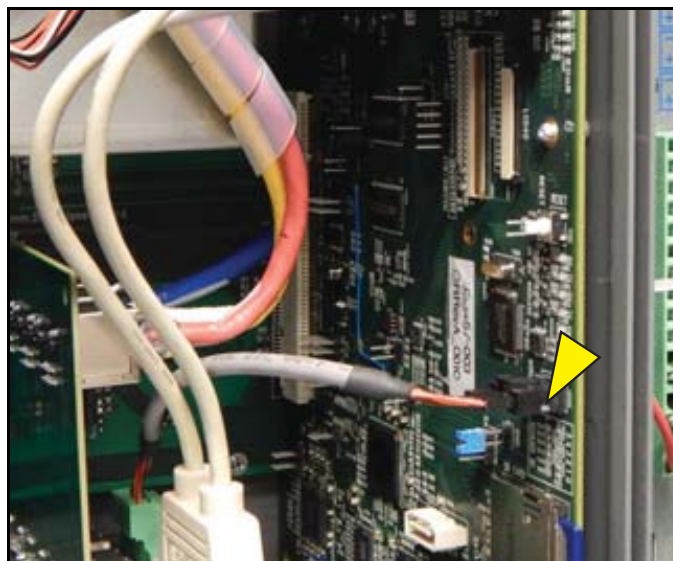

Figure 18. Connect Wireless Cable

6. Connect the two USB module USB cables (labeled 3 and 4) to the CPU board USB 3 and 4 connectors (see Figure 19).

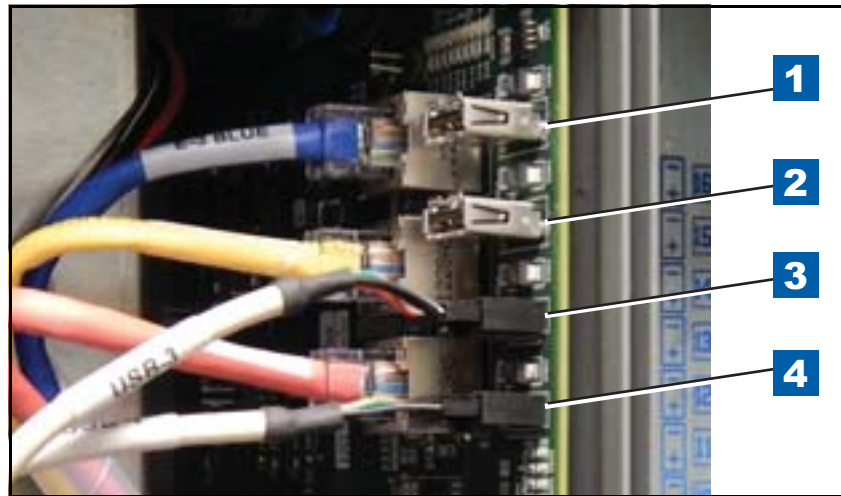

Figure 19. Connect USB Module Cables

7. If there is an optional printer, connect its USB cable to the CPU board's USB 1 (top) connector (see Figure 20).



Figure 20. Connect Optional Printer USB Cable

Installing New TLS-450PLUS Display Door

1. Install the new TLS-450PLUS Display door on the console by attaching the door top and bottom hinges to the console. Use the two hinge shoulder screws retained following removal of the TLS-450 Display door (see Figure 21).



Figure 21. Install The New TLS-450PLUS Display Door

2. Connect the Ground cable to the Display door (see Figure 22).

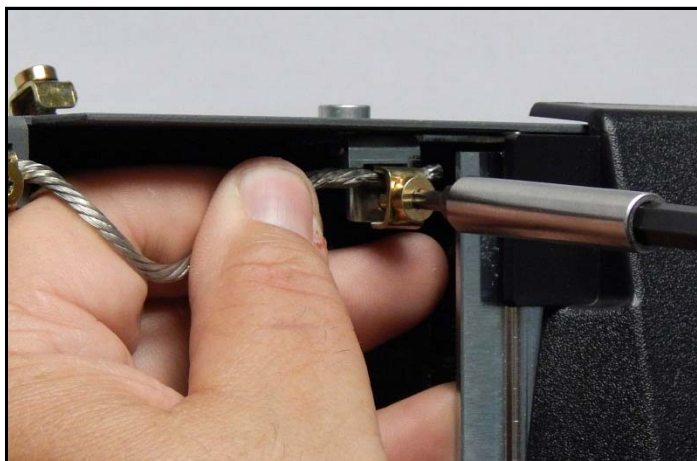

Figure 22. Connect The Ground Cable

3. Connect the Display door Display Data cable (pointer 1) and the LED Backlight cable (pointer 2) to their CPU board connectors (see Figure 23). If necessary rotate the Display Data cable's locking flap (1a in Figure 23) up from the CPU connector and insert end of the Display Data ribbon cable fully into the connector then push down on the flap (1a) until it rests against the connector. Verify the Display Data ribbon cable is securely seated in the connector and that the flap is down against the connector as shown in the enlarged section. If inserted fully, the blue end of the cable will be no more than 3/16" (4.8mm) out of the connector as shown.

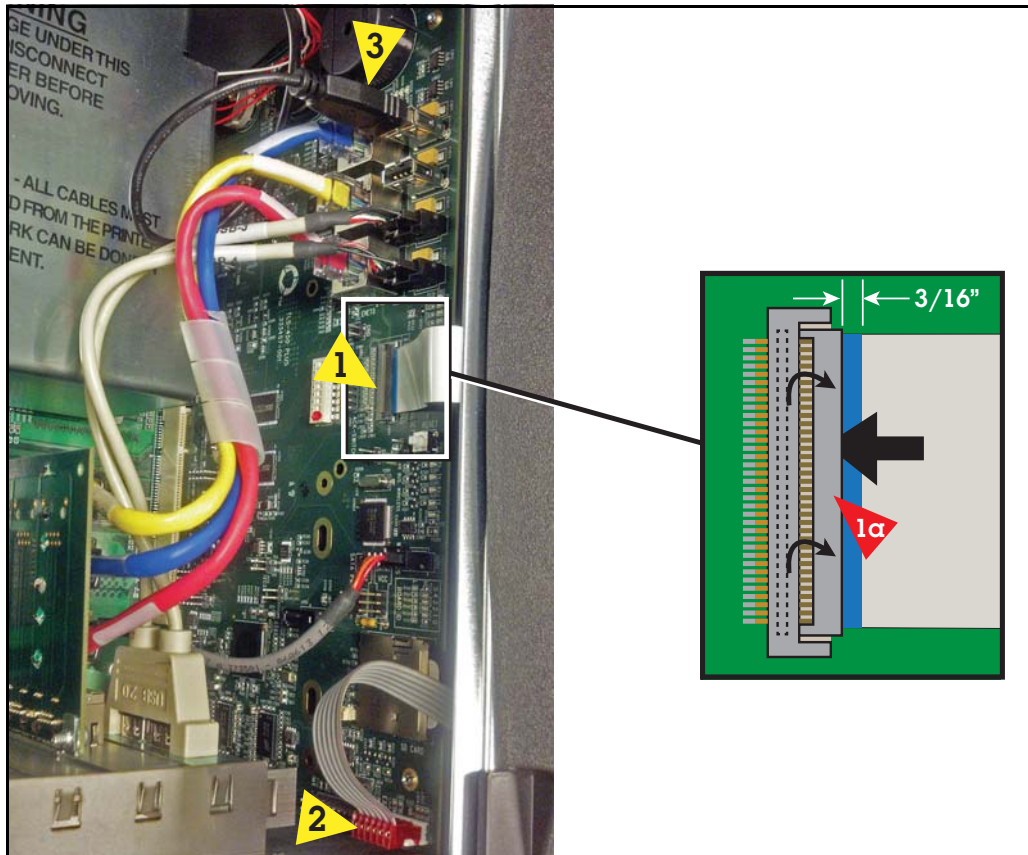

Figure 23. Connect Data Display And LED Backlight Cables To CPU Board

4. Prior to closing the console doors, check the SD card on the CPU board to confirm that the SD card is fully engaged into it's slot and is facing the correct direction (see Figure 24).



Figure 24. Locating SD Card On CPU Board

5. Press the outer edge of the SD card towards the interior of its enclosure and it should spring out so it can be removed. Remove the SD card and check that the read/write-protect switch on the side of the card is in the position shown in (item 1 Figure 25). Insert the SD card into its enclosure with the contact side facing the CPU board (item 2) and gently push the card into its enclosure until it clicks into the enclosure's latch.

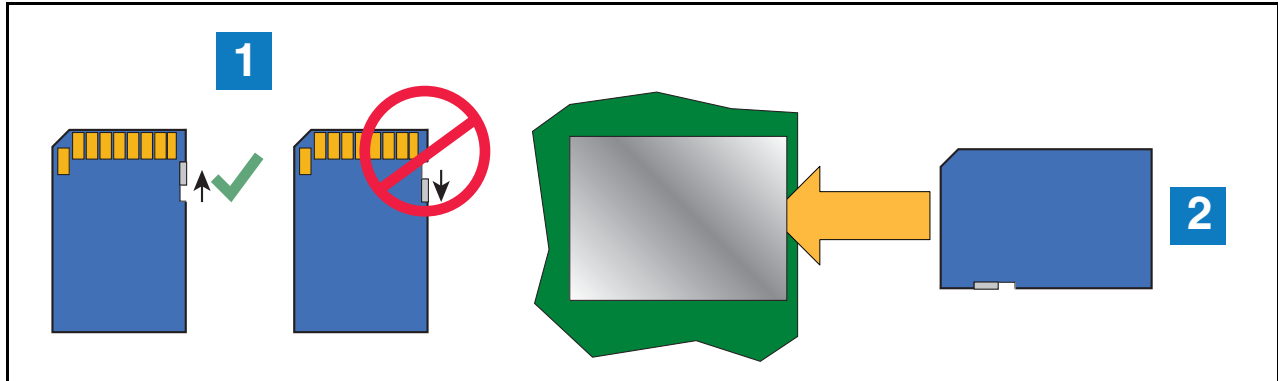

Figure 25. Installing SD Card

6. Close and secure the two doors of the console by reversing the procedure in Step 2 of "Removing The Display Door" on page 6.

Initializing The TLS-450PLUS Console After The Upgrade

After installing the TLS-450PLUS upgrade follow the appropriate initial startup procedure below:

1. **For Sites Without Wireless 2 Devices** - Power up the TLS-450PLUS and wait 5 minutes until the console's 'Discover Mode' is complete.

For Sites With Wireless 2 Devices - Power up all Wireless 2 devices then power up the TLS RF console and wait 5 minutes. Power up the TLS-450PLUS and wait 5 minutes until the console's 'Discover Mode' is complete.



NOTE: The Home Screen may appear before the 'Discover Mode' is complete, however the console may still be in the process of connecting to all of its monitored devices. Waiting 5 minutes ensures all devices have been recognized by the console.

2. Plug the V-R Backup thumbdrive (P/N 332970-004) into one of the two USB ports in the console's communication slot, port 5. Wait one minute before proceeding to the next step.
3. Touch **Menu>Software Maintenance>DB Restore**
4. Select Thumbdrive as the Source.
5. Select Restore.
6. The on-screen instructions will ask to re-boot the console during the DB Restore process. Answer Yes to perform the DB Restore and re-boot the console.

NOTE: Booting the console may take up to three minutes after performing a DB Restore.



For technical support, sales or
other assistance, please visit:
www.veeder.com

A blue rectangular box with a white globe icon at the top. Below the globe, the text "For technical support, sales or other assistance, please visit:" is followed by the website address "www.veeder.com".