

# TLS-XB Expansion Box

## Site Prep and Installation Manual



# Notice

---

Veeder-Root makes no warranty of any kind with regard to this publication, including, but not limited to, the implied warranties of merchantability and fitness for a particular purpose.

**Veeder-Root shall not be liable for errors contained herein or for incidental or consequential damages in connection with the furnishing, performance, or use of this publication.**

Veeder-Root reserves the right to change system options or features, or the information contained in this publication.

This publication contains proprietary information which is protected by copyright. All rights reserved. No part of this publication may be photocopied, reproduced, or translated to another language without the prior written consent of Veeder-Root.

Contact TLS Systems Technical Support for additional troubleshooting information at 800-323-1799.

## **DAMAGE CLAIMS / LOST EQUIPMENT**

Thoroughly examine all components and units as soon as they are received. If any cartons are damaged or missing, write a complete and detailed description of the damage or shortage on the face of the freight bill. The carrier's agent must verify the inspection and sign the description. Refuse only the damaged product, not the entire shipment.

Veeder-Root must be notified of any damages and/or shortages within 30 days of receipt of the shipment, as stated in our Terms and Conditions.

## **VEEDER-ROOT'S PREFERRED CARRIER**

1. Contact Veeder-Root Customer Service at 800-873-3313 with the specific part numbers and quantities that were missing or received damaged.
2. Fax signed Bill of Lading (BOL) to Veeder-Root Customer Service at 800-234-5350.
3. Veeder-Root will file the claim with the carrier and replace the damaged/missing product at no charge to the customer. Customer Service will work with production facility to have the replacement product shipped as soon as possible.

## **CUSTOMER'S PREFERRED CARRIER**

1. It is the customer's responsibility to file a claim with their carrier.
2. Customer may submit a replacement purchase order. Customer is responsible for all charges and freight associated with replacement order. Customer Service will work with production facility to have the replacement product shipped as soon as possible.
3. If "lost" equipment is delivered at a later date and is not needed, Veeder-Root will allow a Return to Stock without a restocking fee.
4. Veeder-Root will NOT be responsible for any compensation when a customer chooses their own carrier.

## **RETURN SHIPPING**

For the parts return procedure, please follow the appropriate instructions in the "General Returned Goods Policy" pages in the "Policies and Literature" section of the Veeder-Root **North American Environmental Products** price list. Veeder-Root will not accept any return product without a Return Goods Authorization (RGA) number clearly printed on the outside of the package.

## Introduction

Contractor Certification Requirements .....	1
Related Documents .....	2
Documents Required to Install Equipment .....	2
Safety Precautions .....	2
National Electrical Code Compliance .....	3
Probe and Sensor Wiring Runs .....	3
Sensor and Probe Junction Boxes .....	4
Permissible TLS-XB Expansion Box Input/Output Connections .....	4

## Planning Probe and Sensor Installations .....6

### TLS-XB Expansion Box Installation

Locating the TLS-XB Expansion Box .....	8
Mounting the TLS-XB Expansion Box .....	8
TLS-XB Protective Grounding .....	8

### Connecting Devices To The TLS-XB Expansion Box

Probe and Sensor Wiring Precautions .....	10
Connecting Wiring to TLS-XB Modules .....	10

### Connecting To Consoles

Connecting A TLS-450PLUS Console To A TLS-XB Expansion Box .....	17
Connecting A TLS4 Console To A TLS-XB Expansion Box .....	18
TLS-XB Backplane Switch (SW1) Settings .....	19
TLS-XB VR Bus Termination Jumper (JP1) Settings .....	19
VR Bus Termination Jumper Location .....	19
VR Bus Termination Jumper Positions.....	20

## Figures

Figure 1.	TLS-XB Expansion Box - Plug-in Module Slots (Cover Removed) .....	5
Figure 2.	TLS-XB System Typical Site/Forecourt Layout .....	7
Figure 3.	TLS-XB Expansion Box Dimensions and Designated Conduit Knockouts .....	9
Figure 4.	Removing The TLS-XB Expansion Box Cover .....	11
Figure 5.	Connecting 2- and 3-wire Intrinsically-safe Devices to USM Module .....	12
Figure 6.	Connecting Devices to the MDIM Module .....	13
Figure 7.	Connecting Devices to the LVDIM Module .....	14
Figure 8.	Connecting Devices to the 10A Controller Module (Slot 4 Only) .....	15
Figure 9.	I/O Relay Module Connections .....	16
Figure 10.	TLS-450PLUS Console To TLS-XB Expansion Box Cable Connection .....	17
Figure 11.	TLS4 Console To TLS-XB Expansion Box Cable Connection .....	18
Figure 12.	TLS-XB Expansion Box Backplane Switch .....	19
Figure 13.	TLS-XB VR Bus Termination Jumper location on the I/O backplane board .....	19
Figure 14.	TLS-XB VR Bus Termination Jumper positions .....	20

## Tables

Table 1.	TLS-XB Compatible Devices .....	1
Table 2.	TLS-XB JP1 Positions - TLS-450PLUS Only .....	20

# Introduction

The TLS-XB Expansion Box provides increased device monitoring capabilities in sites having a TLS4 or TLS-450PLUS console. Up to three TLS-XB Expansion Boxes may be connected to a TLS-450PLUS console and one TLS-XB Expansion Box may be connected to a TLS4 console. Table 1 lists the maximum inputs that can be monitored by each of the available TLS-XB modules. Actual devices monitored at your site will depend on the modules ordered with your TLS-XB(s).

**Table 1. TLS-XB Compatible Devices**

Device Name	Module Type	Maximum Inputs Per Module
DPLLD	Universal Sensor Module (USM)	16
Probes		
Sensors		
Mechanical Pulser	Mechanical Dispenser Interface Module (MDIM)	12
Low Voltage Pulser	Low Voltage Dispenser Interface Module (LVDIM)	12
Input/Output	Input/Output Interface Module (UIOM)	5 Dry Contact Relays, 5 High Voltage Inputs, 4 External Dry Contacts
	10 Amp Controller Module ( <i>Must be installed in Slot 4 only</i> )	6 Inputs/6 Outputs

This manual assumes that you are installing the TLS-XB(s) in a new site (before pavement is put down and with no wiring runs in place). Among the topics covered are:

- Site layout considerations.
- Installing the TLS-XB Expansion Box
- Device-to-TLS-XB wiring connection examples.

## Contractor Certification Requirements

Veeder-Root requires the following minimum training certifications for contractors who will install and setup the equipment discussed in this manual:

**Installer Certification (Level 1):** Contractors holding valid Installer Certification are approved to perform wiring and conduit routing; equipment mounting; probe, sensor and carbon canister vapor polisher installation; wireless equipment installation; tank and line preparation; and line leak detector installation.

**Technician Certification (Level 2/3):** Contractors holding valid Technician Certifications are approved to perform installation checkout, startup, programming and operations training, system tests, troubleshooting and servicing for all Veeder-Root Series Tank Monitoring Systems, including Line Leak Detection. In addition, Contractors with the following sub-certification designations are approved to perform installation checkout, startup, programming, system tests, troubleshooting, service techniques and operations training on the designated system.

- Wireless 2
- Tall Tank

**VR Vapor Products Certification:** Contractors holding a certification with the following designations are approved to perform installation checkout, startup, programming, system tests, troubleshooting, service techniques and operations training on the designated system.

- ISD – In Station Diagnostics
- PMC – Pressure Management Control
- CCVP - Veeder-Root Vapor Polisher Wireless – ISD/PMC Wireless
- A current Veeder-Root Technician Certification is a prerequisite for the VR Vapor Products course.

**Warranty Registrations** may only be submitted by selected Distributors.

## Related Documents











### DOCUMENTS REQUIRED TO INSTALL EQUIPMENT

This equipment must be installed according to the applicable installation document:

Associated Apparatus	ATEX Descriptive System	IECEX Descriptive System	UL/cUL Control Drawing
	Document No.	Document No.	Document No.
TLS-XB	331940-020	331940-120	331940-019
TLS-450PLUS	331940-006	331940-106	331940-008
TLS4	331940-017	331940-117	331940-018

### Safety Precautions

The following safety symbols may be used throughout this manual to alert you to important safety hazards and precautions.

 <p><b>EXPLOSIVE</b> Fuels and their vapors are extremely explosive if ignited.</p>	 <p><b>FLAMMABLE</b> Fuels and their vapors are extremely flammable.</p>
 <p><b>ELECTRICITY</b> High voltage exists in, and is supplied to, the device. A potential shock hazard exists.</p>	 <p><b>TURN ELECTRICAL POWER OFF</b> Live power to a device creates a potential shock hazard. Turn Off electrical power to the device and associated accessories when servicing the unit.</p>
 <p><b>GLOVES</b> Wear gloves to protect hands from irritation or injury.</p>	 <p><b>WEAR EYE PROTECTION</b> Wear eye protection when working with pressurized fuel lines or epoxy sealant to avoid possible eye injury.</p>
 <p><b>READ ALL RELATED MANUALS</b> Knowledge of all related procedures before you begin work is important. Read and understand all manuals thoroughly. If you do not understand a procedure, ask someone who does.</p>	 <p><b>INJURY</b> Careless or improper handling of materials can result in bodily injury.</p>
 <p><b>NOTICE</b> NOTICE is used to address practices not related to physical injury.</p>	 <p><b>WARNING</b> WARNING indicates a hazardous situation which, if not avoided, could result in death or serious injury.</p>

---

## National Electrical Code Compliance

---

The following information is for general reference and is not intended to replace recommended National Electric Code (NEC) procedures. It is important for the installer to understand that electrical equipment and wiring located in Class I, Division 1 and 2 installations shall comply with the latest appropriate Articles found in the National Electric Code (NFPA 70) and the Code for Motor Fuel Dispensing Facilities and Repair Garages, (NFPA 30A).

### Connecting to the 240 Vac electrical power supply

Ensure that all local and national electrical regulations and codes are complied with when connecting the TLS-XB expansion Box to the mains electrical supply.

**⚠ WARNING** The equipment described in this manual must only be installed and commissioned by trained personnel. Installers must have the appropriate technical competence required to:

- Carry out operations in all areas required to be accessed during the installation work.
- Be aware of the hazards involved during the installation work and take all necessary precautions to ensure a safe working environment.

Always evaluate the risk associated with working in hazardous areas in line with IEC/EN60079-10 and any applicable local regulations (note: some Countries require installers operating in or near hazardous locations to obtain a special local permit/approval).

### PROBE AND SENSOR WIRING RUNS

#### Wire Type

To ensure the best operating systems available, Veeder-Root **REQUIRES** the use of shielded cable for all probes and sensors regardless of conduit material or application. In these installations, shielded cable must be rated less than 100 picofarad per foot and be manufactured with a material suitable for the environment, such as Carol™ C2534 or Belden™ 88760, 8760, 8770 or similar.

Note: Throughout this manual, when mentioning any cable or wire being used for probe and sensor wiring to the TLS-XB Expansion Box, it will be referring to shielded cable.

#### Wire Length

Improper system operation could result in undetected potential environmental and health hazards if the probe- or sensor-to-TLS-XB wire runs exceed 1000 feet. Wire runs must be less than 1000 feet to meet intrinsic safety requirements.

#### Splices

Veeder-Root recommends that no splices be made in the wire run between a sensor or probe junction box and the TLS-XB. Each splice degrades signal strength and could result in poor system performance.

#### Wire Gauge - Color coded

- Shielded cable must be used in all installations. Sensor-to-TLS-XB wires should be #14-#18 AWG stranded copper wire and installed as a Class 1 circuit. As an alternate method when approved by the local authority having jurisdiction, 22 AWG wire such as Belden 88761 may be suitable in installations with the following provisions:
  - Wire run is less than 750 feet
  - Capacitance does not exceed 100 pF/foot
  - Inductance does not exceed 0.2  $\mu$ H/foot

**SENSOR AND PROBE JUNCTION BOXES**

Weatherproof electrical junction boxes with a gasketed cover are required on the end of each probe and sensor conduit run at the manhole or monitoring well location. Gasketing or sealing compound must be used at each entry to the junction box to ensure a waterproof junction. The interior volume of each junction box must be a minimum of 16 cubic inches.

Veeder-Root recommends the following junction boxes or equivalent:

- Appleton Electric Co. - JBDX junction box, JBK-B cover, and JB-GK-V gasket.
- Crouse-Hinds Co. - GRFX-139 junction box, GRF-10 cover, and GASK-643 gasket.

**Permissible TLS-XB Expansion Box Input/Output Connections**

---

Figure 1 illustrates the permissible slot locations for TLS-XB plug-in modules. Input wiring to each module enters through a knockout in the base of the TLS-XB Expansion Box.

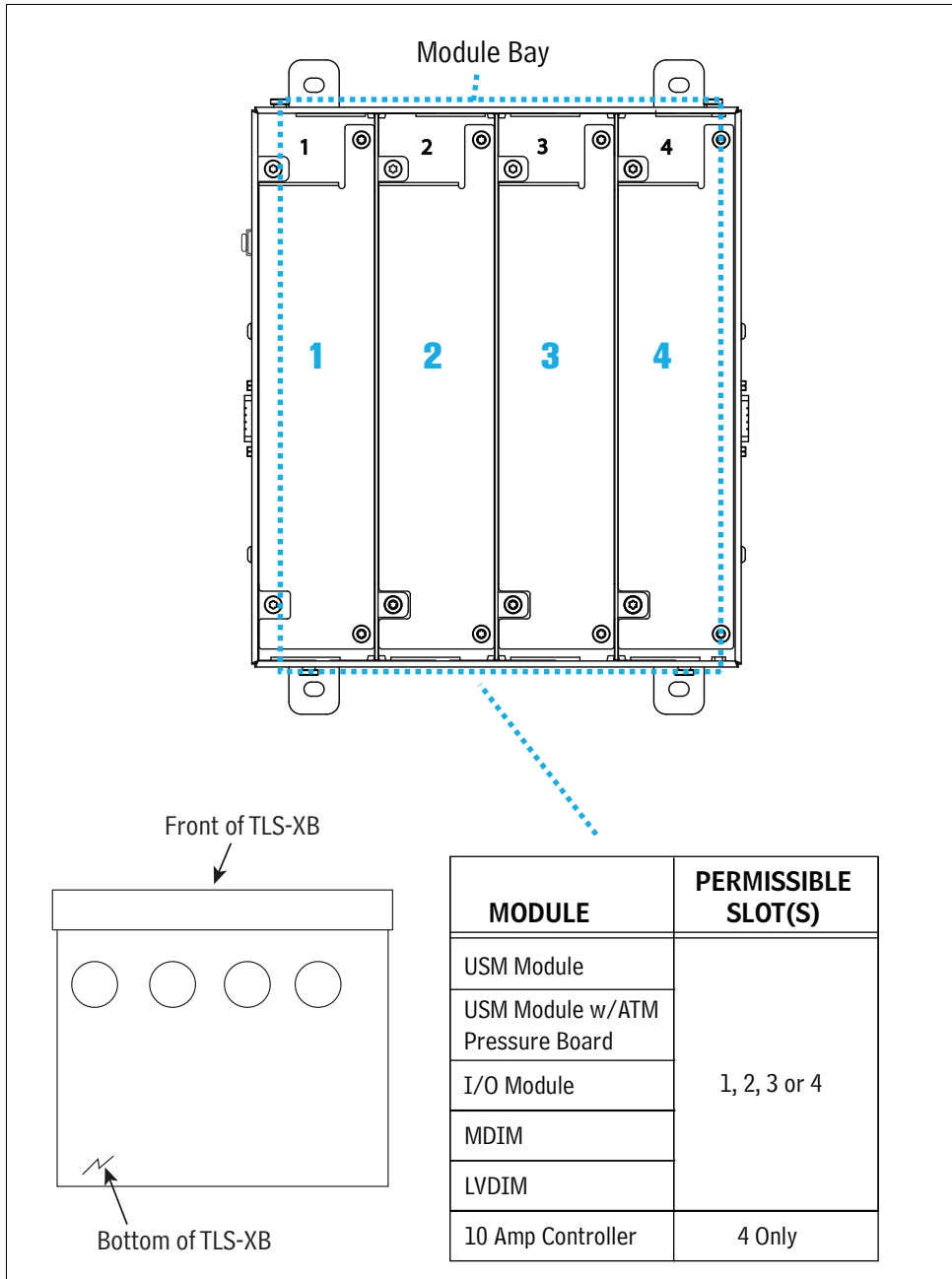

Figure 1. TLS-XB Expansion Box - Plug-in Module Slots (Cover Removed)



## Planning Probe and Sensor Installations

The contractor should diagram, all proposed trench and conduit runs between the TLS-XB's intended location and its deployed sensors and probes. A site diagram will help you to calculate conduit and wiring lengths, and necessary quantities of junction boxes, sealing boxes, clamps, brackets, etc.

Throughout this planning process and in the actual installation, you must follow the latest National Electric Codes, federal, state, and local codes, as regards conduit type, depth below grade, sealing, grounding, wire capacities, etc.

Reminder: to ensure optimum signal strength, plan sensor and probe wiring lengths so that there will be no splices between the field junction box connection and the interface module connection in the TLS-XB. Every splice in the hazardous area requires the use of an epoxy sealing kit which should not be pulled through the conduit and must be located in a separate waterproof, sealed junction box.

To maintain the intrinsically-safe integrity of the installed TLS-XB, sensor and probe conduits can share the same trenches with power conduits, but the intrinsically safe sensor and probe wiring can NOT share the same conduit with any other wiring. Also, the intrinsically safe wiring for the TLS-XB can NOT share the same conduit with another device's intrinsically safe wiring.

Install conduit from all probe and sensor locations to the TLS-XB location. Knockouts for 3/4" and 1" I.P.S. conduit are provided in both the top and bottom of the TLS-XB Expansion Box for probe and sensor wiring.

The conduit must be properly sealed in accordance with the latest National Electric Code (NFPA 70) and the Code for Motor Fuel Dispensing Facilities and Repair Garages (NFPA 30A) since they pass from a Class I, Division 1 or 2 hazardous area into a non-hazardous area. Figure 2 illustrates a typical site deployment of probes and sensors.

If the TLS-XB is being installed into a paved site, you can either dig out trenches in the pavement to run conduit out to sensors and probes as described above, or you can cut grooves in the pavement, run direct burial cable to these devices, and then seal over the cable grooves (if permitted).

**NOTICE** Installation of the Direct Burial System can only be done in those locations where local codes permit the use of buried cable instead of conduit, and epoxy splices instead of junction boxes.

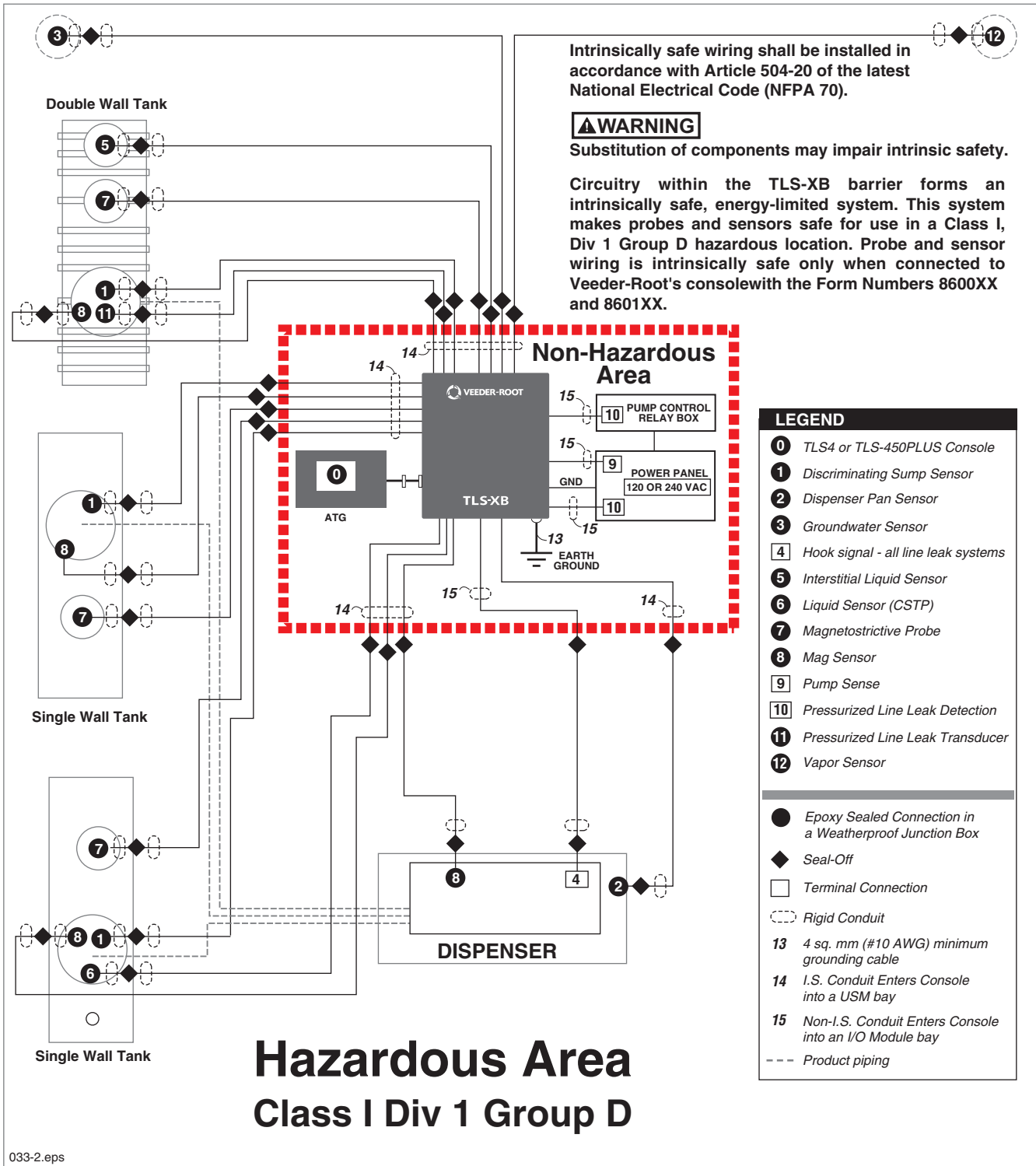

Intrinsically safe wiring shall be installed in accordance with Article 504-20 of the latest National Electrical Code (NFPA 70).

**⚠ WARNING**

Substitution of components may impair intrinsic safety.

Circuitry within the TLS-XB barrier forms an intrinsically safe, energy-limited system. This system makes probes and sensors safe for use in a Class I, Div 1 Group D hazardous location. Probe and sensor wiring is intrinsically safe only when connected to Veeder-Root's console with the Form Numbers 8600XX and 8601XX.

**LEGEND**

- 0 TLS4 or TLS-450PLUS Console
- 1 Discriminating Sump Sensor
- 2 Dispenser Pan Sensor
- 3 Groundwater Sensor
- 4 Hook signal - all line leak systems
- 5 Interstitial Liquid Sensor
- 6 Liquid Sensor (CSTP)
- 7 Magnetostrictive Probe
- 8 Mag Sensor
- 9 Pump Sense
- 10 Pressurized Line Leak Detection
- 11 Pressurized Line Leak Transducer
- 12 Vapor Sensor

● Epoxy Sealed Connection in a Weatherproof Junction Box

◆ Seal-Off

□ Terminal Connection

○ Rigid Conduit

13 4 sq. mm (#10 AWG) minimum grounding cable

14 I.S. Conduit Enters Console into a USM bay

15 Non-I.S. Conduit Enters Console into an I/O Module bay

--- Product piping

## TLS-XB Expansion Box Installation

### Locating the TLS-XB Expansion Box

---

<b>⚠ WARNING</b>	
	<p><b>FAILURE TO COMPLY WITH THE FOLLOWING WARNINGS AND SAFETY PRECAUTIONS COULD CAUSE DAMAGE TO PROPERTY, ENVIRONMENT, RESULTING IN SERIOUS INJURY OR DEATH.</b></p> <p><b>Explosive vapors or flammable liquids could be present near locations where fuels are stored or being dispensed.</b></p> <p><b>The TLS-XB Expansion Box is not explosion proof. Do not install the TLS-XB in a volatile, combustible, or explosive atmosphere.</b></p> <p><b>An explosion or fire resulting in serious injury or death, property loss and equipment damage could occur if the TLS-XB is installed in a volatile, combustible or explosive atmosphere (Class I, Division 1 or 2).</b></p>

Select a mounting location on the inside of any building. The TLS-XB Expansion Box must be protected from severe vibration, extremes in temperature and humidity, rain, and other conditions that could harm computerized electronic equipment. The TLS-XB has an operating temperature range of 32 to 104°F (0 to 40°C), and a storage temperature range of -40 to +162°F (-40 to +74°C).

The mounting surface should be strong enough to support the weight of the TLS-XB which could be approximately 20 pounds with a full complement of modules. You should also consider wall space for routing the power wiring conduits and probe and sensor wiring conduits that must be connected to the TLS-XB.

### Mounting the TLS-XB Expansion Box

---

Mount the TLS-XB to the mounting surface using the four mounting flanges on the back of the unit. Install the TLS-XB fastening devices to the mounting surface using the hole pattern shown in Figure 3. Up to 1/4" diameter screws may be used.

### TLS-XB Protective Grounding

---

The TLS-XB Expansion Box's grounding clamp (see Figure 4) must be connected to a separate earth ground using 4 mm<sup>2</sup> (#10AWG) minimum cable.

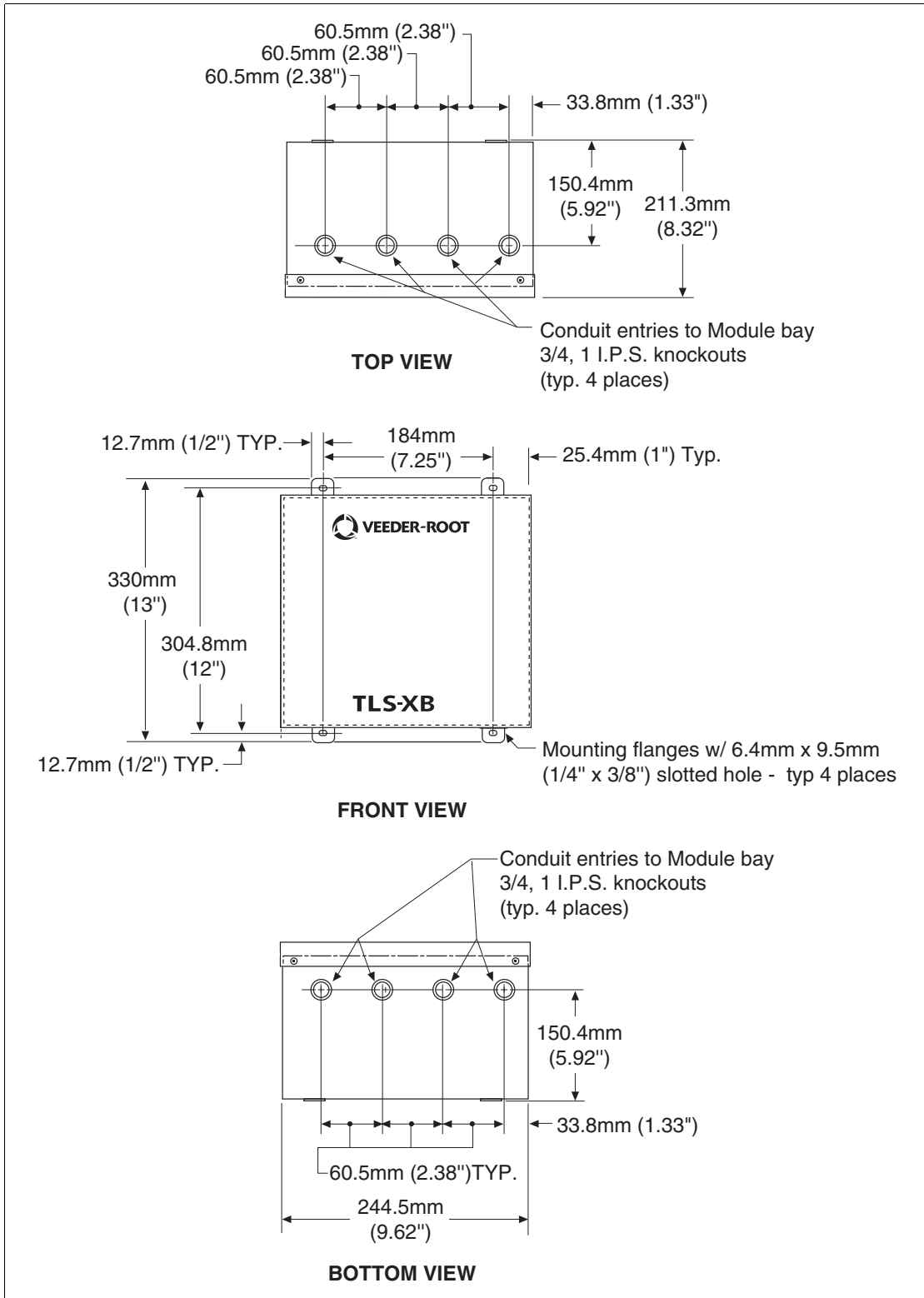



Figure 3. TLS-XB Expansion Box Dimensions and Designated Conduit Knockouts

## Connecting Devices To The TLS-XB Expansion Box

<b>⚠ WARNING</b>	
	<p><b>FAILURE TO COMPLY WITH THE FOLLOWING WARNINGS AND SAFETY PRECAUTIONS COULD CAUSE DAMAGE TO PROPERTY, ENVIRONMENT, RESULTING IN SERIOUS INJURY OR DEATH.</b></p> <p>The equipment is used in location where lethal voltages and explosive vapors or flammable fuels may be present.</p> <p>Care must be taken when installing, servicing or replacing parts in the system or serious injury or death from explosion, fire or shock may occur.</p> <p>For this system:</p> <ol style="list-style-type: none"><li>1. Comply with the latest National Electric Code, federal, state, and local codes, and any other applicable safety codes. In addition, take necessary precautions during installation, service, and repair to prevent personal injury, property loss and equipment damage.</li><li>2. Refer servicing to trained and qualified personnel only.</li><li>3. Substitution of components may impair intrinsic safety.</li><li>4. Be sure AC power is "OFF" before opening the TLS-XB door and connecting device wiring. Do not short any voltage across any barrier terminal including sensors or probes.</li></ol>
	

### Probe and Sensor Wiring Precautions



**IMPORTANT** - Read and understand this information prior to wiring devices to the TLS-XB Expansion Box.

**⚠ WARNING**

During programming, the devices wired to each connector are identified and stored in system memory. If a device is later removed and reconnected to a different set of connectors, the system will not properly recognize the data being received. Once a device has been wired to certain connectors on a USM or I/O Module and the system has been programmed, the wires from that device may not be relocated to other connectors without reprogramming that device.

### Connecting Wiring to TLS-XB Modules

**⚠ WARNING**

**Only intrinsically-safe wiring can enter a USM module slot's knockouts.**

Refer to Control Drawing for TLS-XB Expansion Boxes, P/N 331940-019, to identify modules installed in the TLS-XB and the designated devices that can be connected to them.

Try not to have too much wire in the TLS-XB. Pull unneeded wire back into the wiring trough and loop it neatly.

1. Using a T-15 Torx driver, remove the top and bottom screws securing cover and lift cover off enclosure (see Figure 4).
2. For sensors and probes, terminate the ground shields to the ground lug on the module, not at the probe or sensor.
3. Write in the device name for each wire connection on the connector block in the module's wiring label attached to the inside of the cover.
4. Loop the wire neatly under the lip of the module out of the way of the cover.

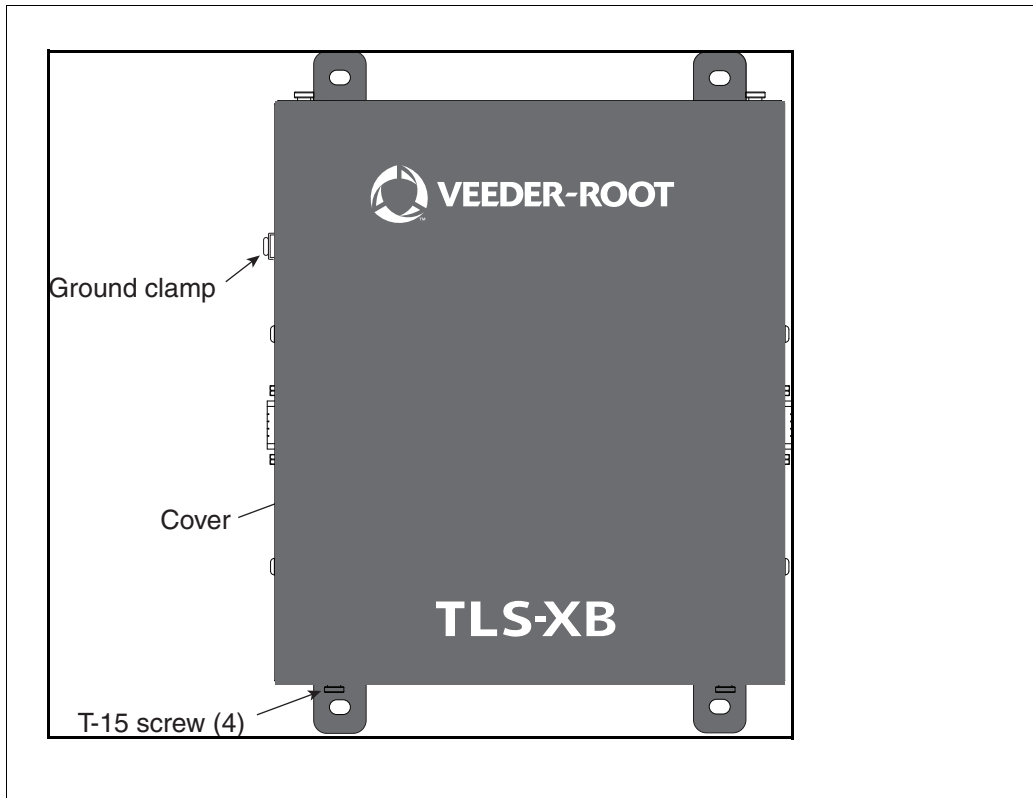

Figure 4. Removing The TLS-XB Expansion Box Cover

5. Refer to the figures below for USM, MDIM, LVDIM, 10A Controller and I/O module wiring connection examples:

Figure 5 - USM module Intrinsically-safe wiring connections

Figure 6 - MDIM module wiring connections

Figure 7 - LVDIM module wiring connections

Figure 8 - 10A Controller Module wiring connections

Figure 9 - I/O module wiring connections

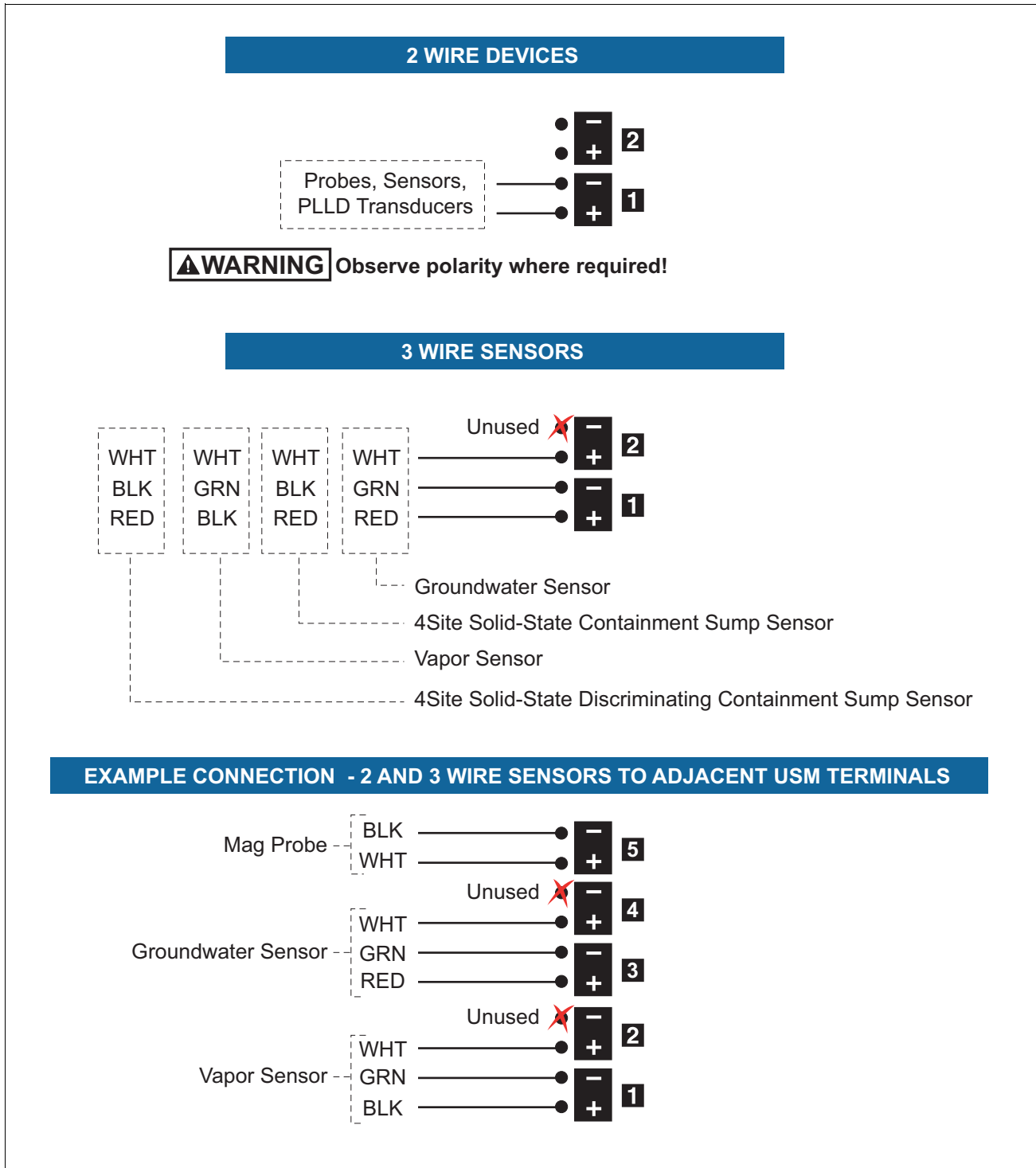

Figure 5. Connecting 2- and 3-wire Intrinsically-safe Devices to USM Module

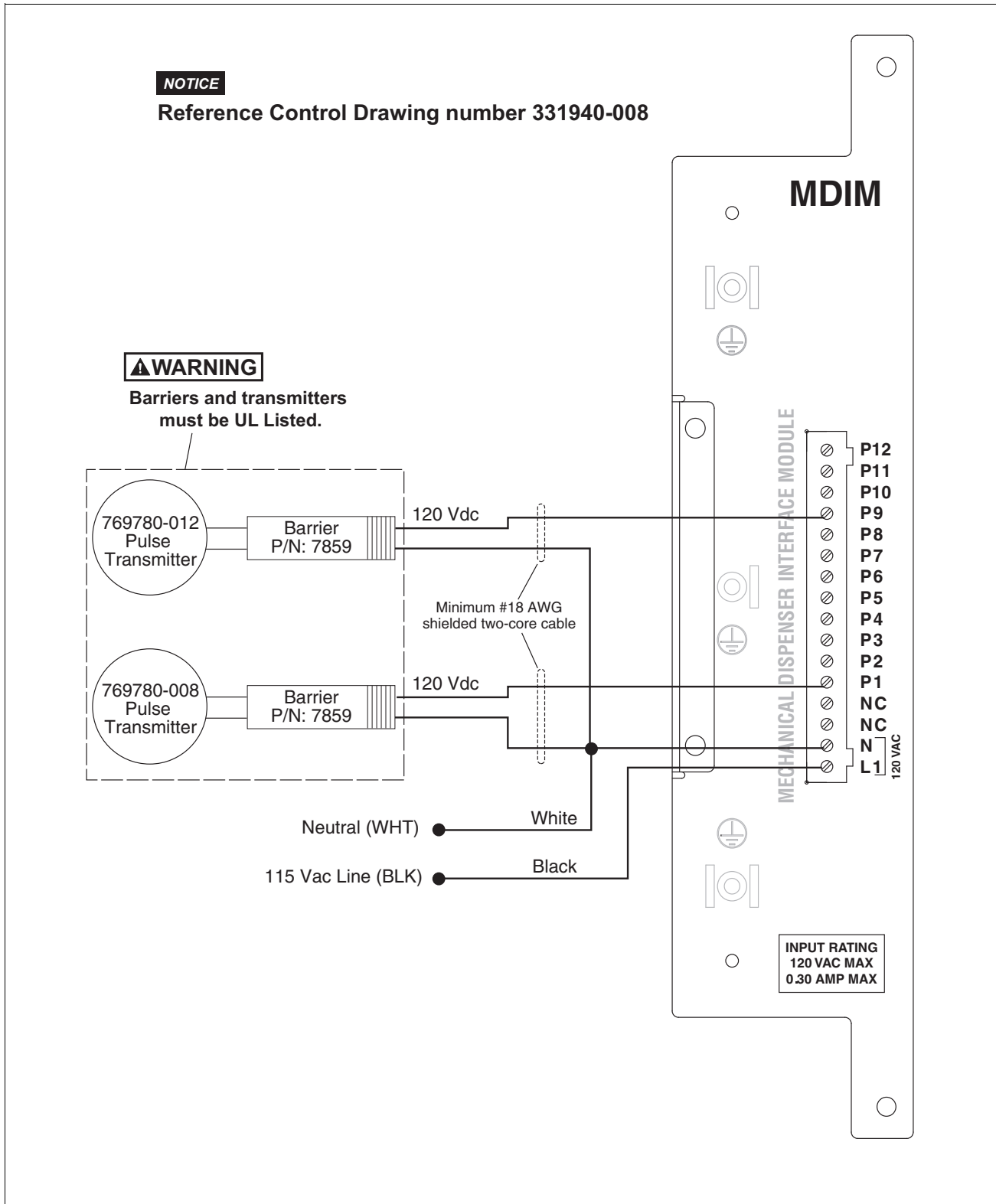

Figure 6. Connecting Devices to the MDIM Module



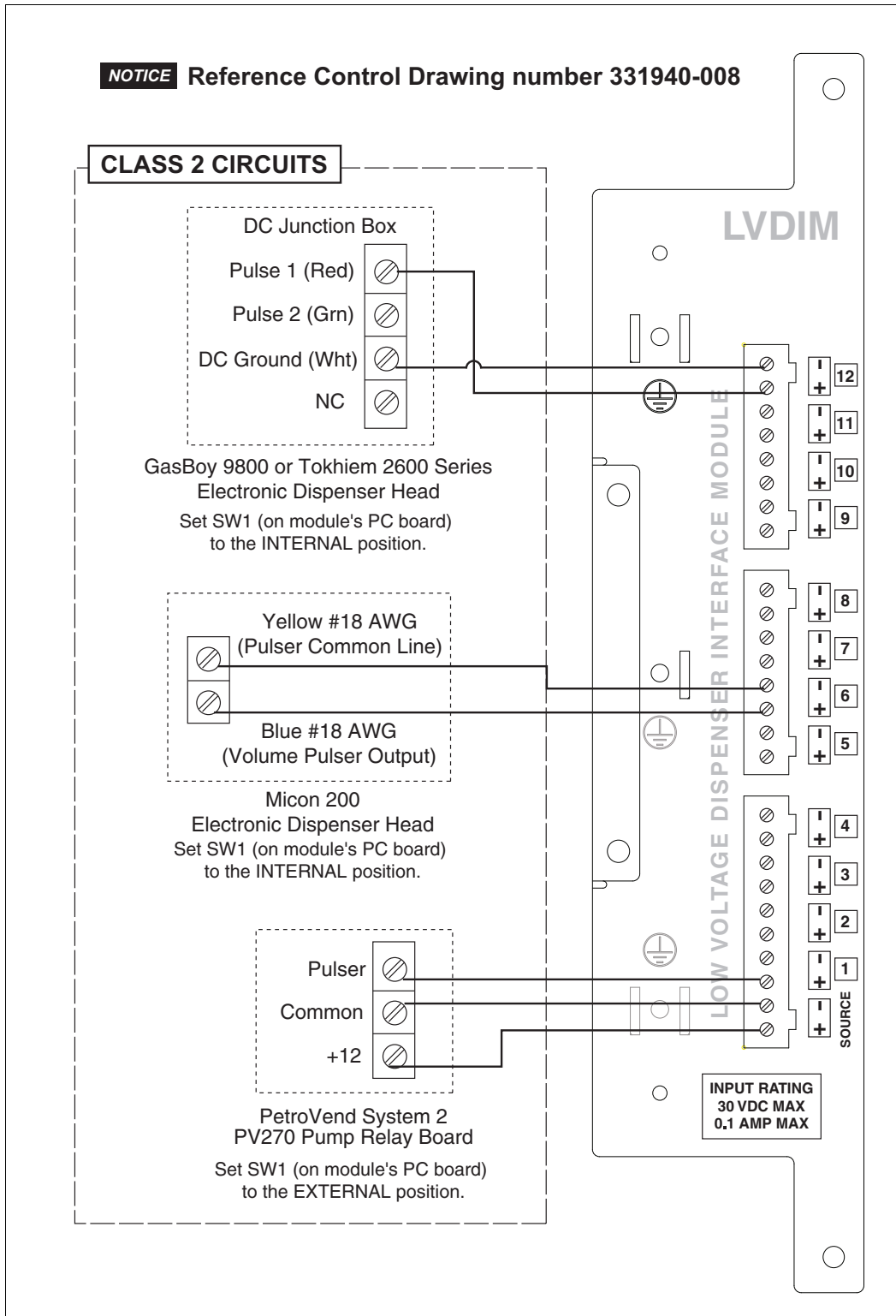

Figure 7. Connecting Devices to the LVDIM Module

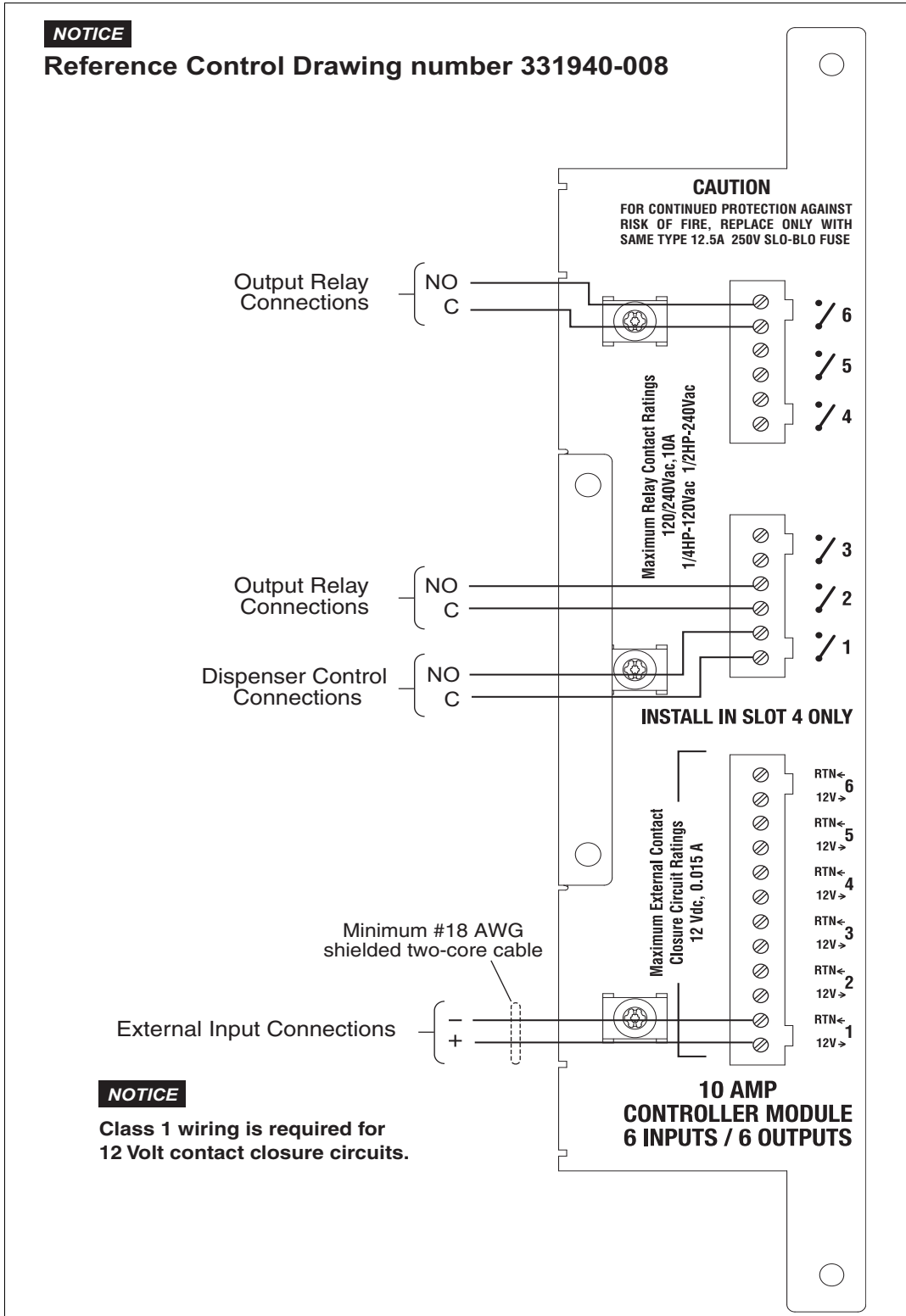

Figure 8. Connecting Devices to the 10A Controller Module (Slot 4 Only)

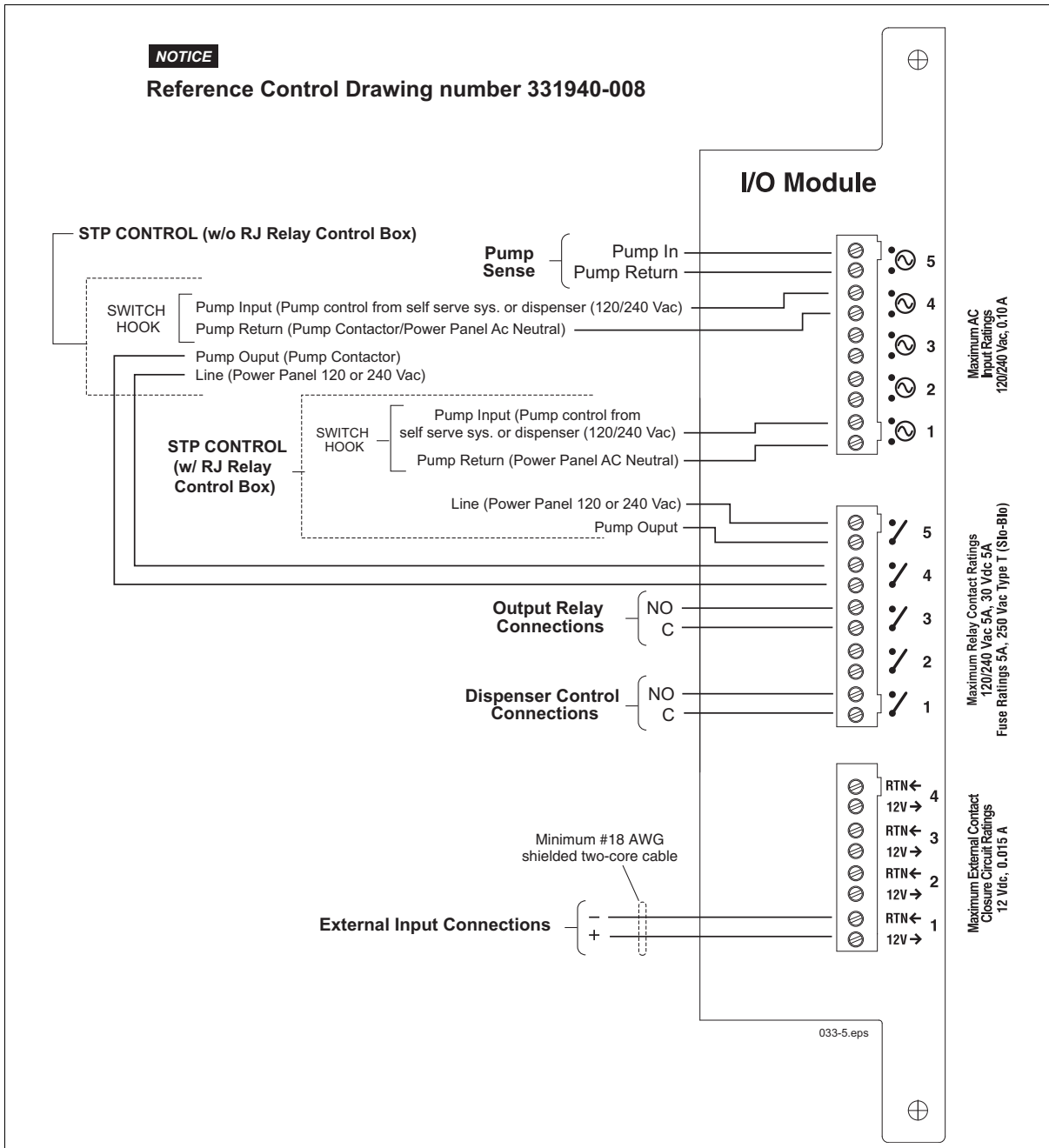

Figure 9. I/O Relay Module Connections

**Important Output Relay Connection Restrictions**

1. Do not connect output relays to a device that draws more than 5 amperes of current. Output power: output relay contact, resistive load - 120/240 Vac, 24 Vdc, 5 A max.
2. Alarm relays cannot be used for flow control. Alarm relays provide only a momentary closure and cannot actuate flow control devices such as valves and pump motor relays.

## Connecting To Consoles

### Connecting A TLS-450PLUS Console To A TLS-XB Expansion Box

#### ⚠ WARNING



The TLS-450PLUS console contains high voltages which can be lethal. It is also connected to low power devices that must be kept intrinsically safe.

1. Turnoff, tag and lock out power at the circuit breaker.
2. Routing conduit for power wires into the intrinsically safe compartments can result in fire or explosion resulting in serious injury or death.

Remove the expansion cover plate on the TLS-450PLUS and insert the expansion module group (PN 332856-001) into the opening in the enclosure. Connect the expansion cable assembly from the TLS-450PLUS to the input port of the TLS-XB (see Figure 10). To connect additional TLS-XB Expansion Boxes, remove the output port's cover plate on the first TLS-XB and insert the expansion module group (PN 332856-001) into the output port and connect the expansion cable assembly from the first TLS-XB to the input port of the second TLS-XB.

NOTE: The TLS-450PLUS console can support up to 3 TLS-XB Expansion Boxes.

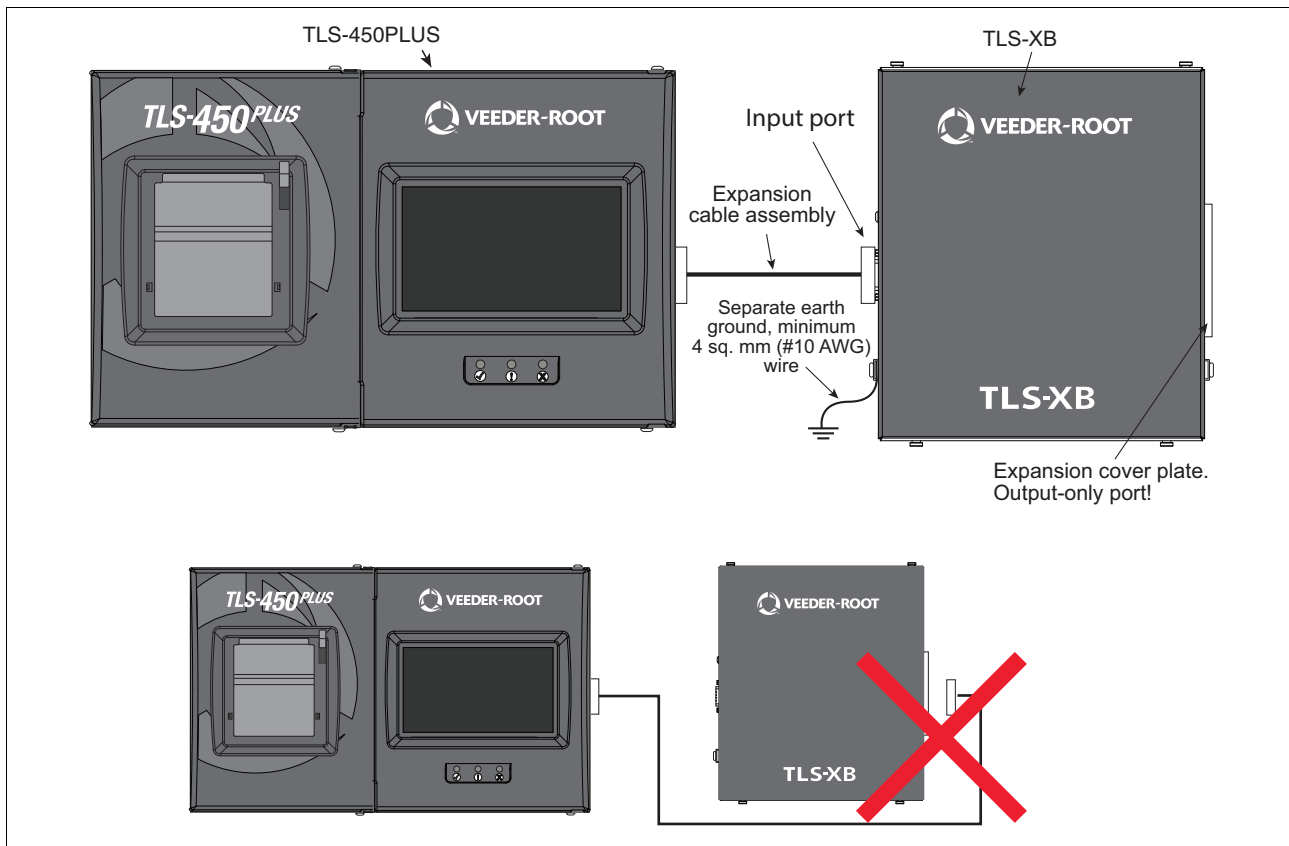



Figure 10. TLS-450PLUS Console To TLS-XB Expansion Box Cable Connection

### Connecting A TLS4 Console To A TLS-XB Expansion Box

<b>⚠ WARNING</b>	
	<p>The TLS4 console contains high voltages which can be lethal. It is also connected to low power devices that must be kept intrinsically safe.</p> <ol style="list-style-type: none"><li>1. Turn off, tag and lock out power at the circuit breaker.</li><li>2. Routing conduit for power wires into the intrinsically safe compartments can result in fire or explosion resulting in serious injury or death.</li></ol>

Connect the expansion cable assembly from the TLS4 to the input port of the TLS-XB (see Figure 11).

NOTE: The TLS4 console can support only one TLS-XB Expansion Box.

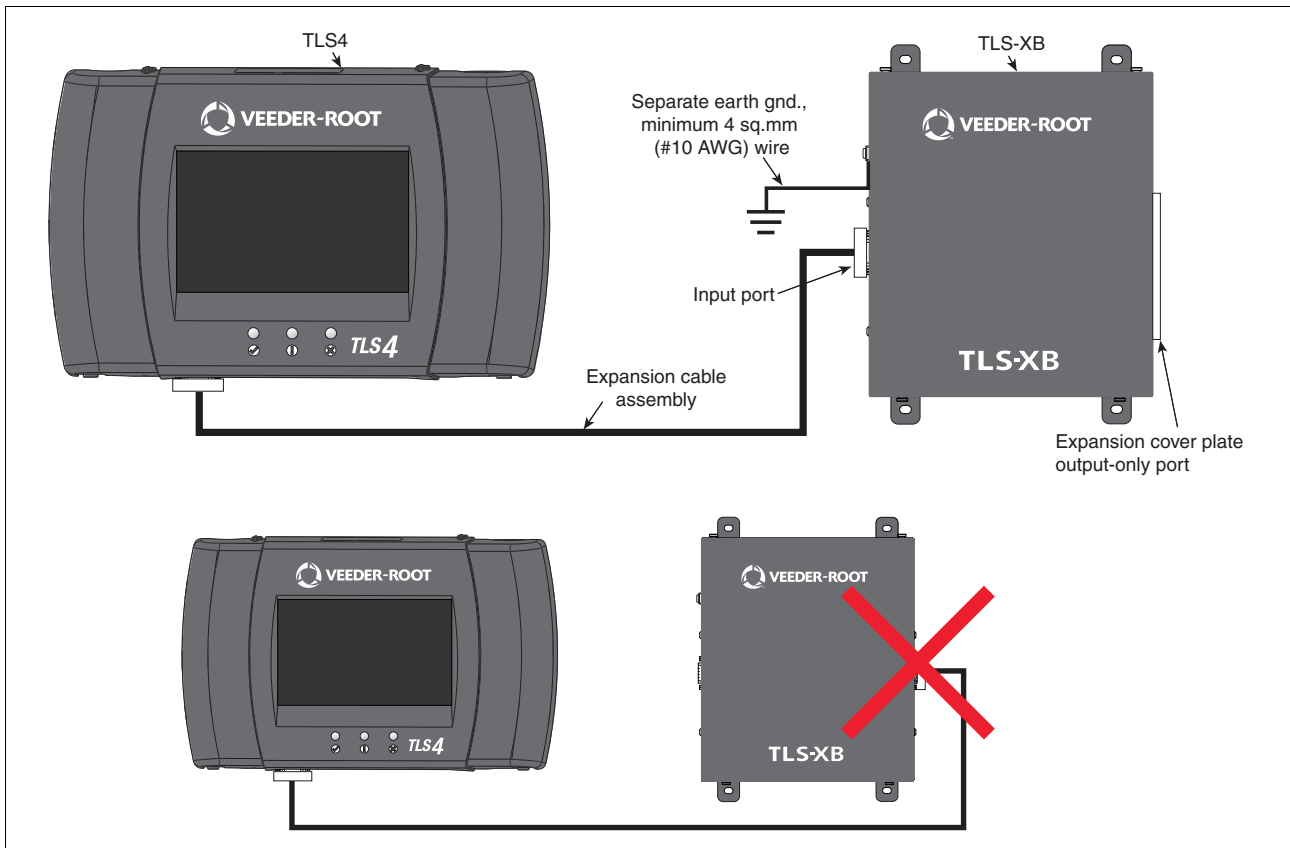

Figure 11. TLS4 Console To TLS-XB Expansion Box Cable Connection

## TLS-XB Backplane Switch (SW1) Settings

When more than one TLS-XB Expansion Box is connected to the TLS-450PLUS, the backplane switch in each TLS-XB must be set as shown in Figure 12. Leave TLS-XB switch SW1 in the default position (1) when connected to a TLS4. Note: only one TLS-XB can be connected to a TLS4.

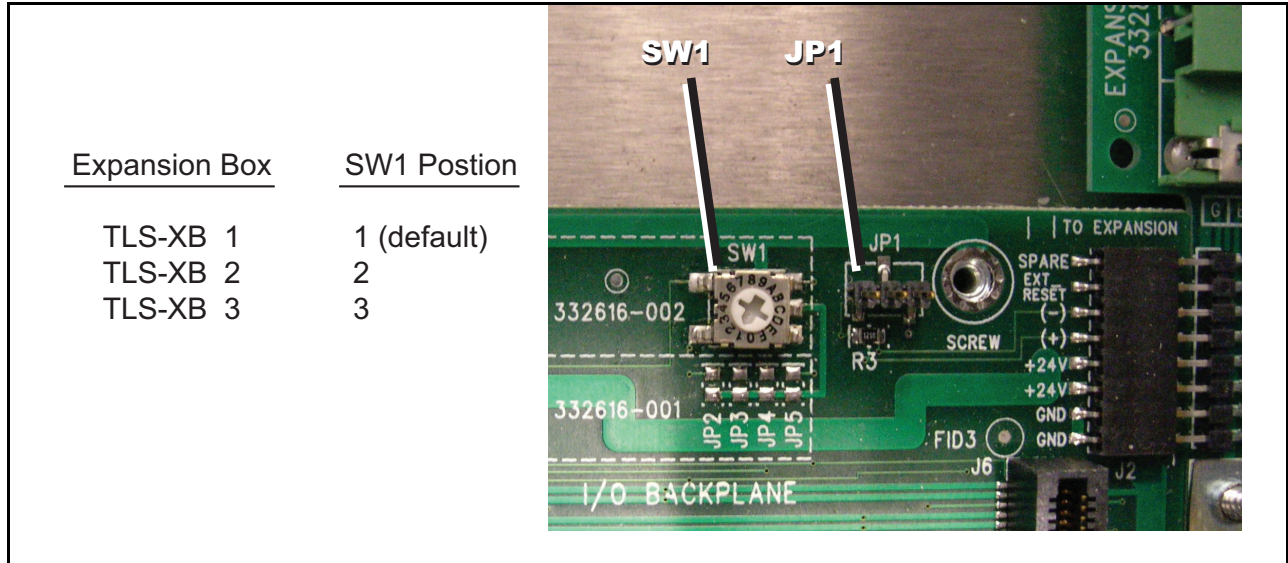

Figure 12. TLS-XB Expansion Box Backplane Switch

## TLS-XB VR Bus Termination Jumper (JP1) Settings

### VR BUS TERMINATION JUMPER LOCATION

Figure 13 shows the location of VR Bus Termination Jumper in the TLS-XB Expansion Box.

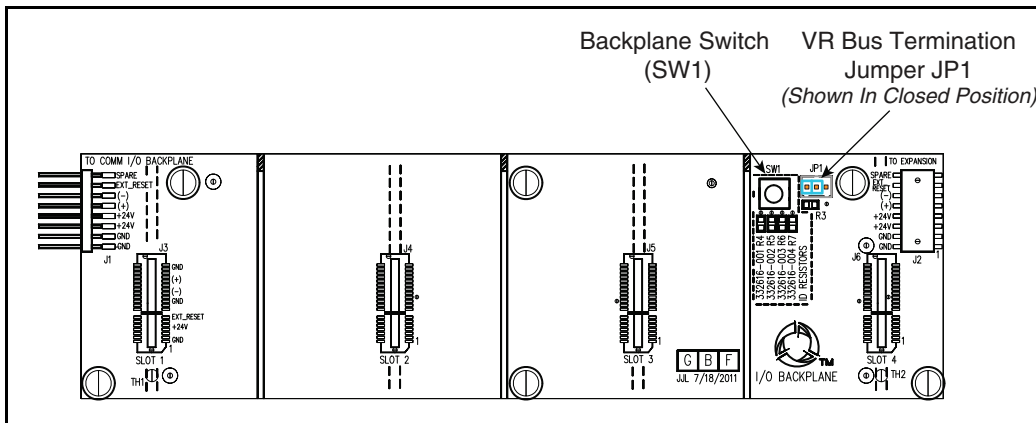
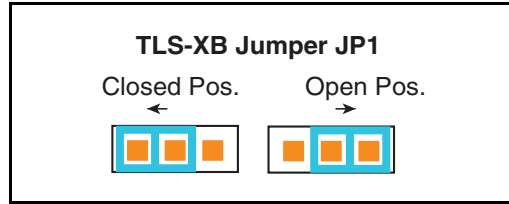

Figure 13. TLS-XB VR Bus Termination Jumper location on the I/O backplane board

**VR BUS TERMINATION JUMPER POSITIONS**

Figure 14 shows the two VR Bus Termination Jumper (JP1) positions in the TLS-XB Expansion Box.



**Figure 14. TLS-XB VR Bus Termination Jumper positions**

**TLS-450PLUS Consoles**

The table below shows the position for the VR Bus Termination Jumper (JP1) in each of up to three TLS-XB Expansion Boxes connected to a TLS-450PLUS console.

**Table 2. TLS-XB JP1 Positions - TLS-450PLUS Only**

Number Of TLS-XB Expansion Boxes	JP1 Position		
	TLS-XB 1	TLS-XB 2	TLS-XB 3
1	Closed		
2	Open	Closed	
3	Open	Open	Closed

**TLS4 Consoles**

Since only one TLS-XB Expansion Box can be connected to a TLS4 console, set TLS-XB jumper JP1 in the Closed position.



For technical support, sales or  
other assistance, please visit:  
[www.veeder.com](http://www.veeder.com)

A blue rectangular box containing a white globe icon at the top and contact information for technical support, sales, and other assistance, including the website [www.veeder.com](http://www.veeder.com).