

LR11, LR16, LR21, LR26 & LR31 Series Manual



TABLE OF CONTENTS

	Page
Section One Introduction:	2
Table of Contents:	2
Sensor Models:	5
Operating Principle:	6
Features:	6
Benefits:	6
Limitations:	6
Specifications:	7
Intrinsically Safe Control Drawings:.....	12
Labels for Intrinsic Safety:	13
Dimensions:	14
Safety Precautions:	17
Section Two Getting Started:	18
Setup Overview:	18
Part Number:	20
Section Three Install Sensor:	22
Installation Requirements:	22
FCC Conformity:.....	23
LR16 Antenna Preparation:	24
Mounting Position:	25
Flange Riser Installation:	28
Beam Angle:	29
Stand Pipe Installation:	30
Bypass Installation:	31
LR31 Sensor Installation:	32
LR98 Display Installation:	33
Section Four Wire Sensor:	34
Terminal Wiring:	34
HART® Wiring:.....	35
HART® Device descriptors (DD files):	35
Standard vs Multidrop:	35
LR31 configuration:	36
LR31 Wiring and Description:.....	36
USING LR98 DISPLAY AS HMI FOR LR31 SERIES:.....	37
Wiring to Displays, Controllers & PLCs:	38
Section Five Configuration Using Display:	40
Basic Configuration Overview:	40
Using the Display:	41
Changing Display Values:	42
Step 1 - Measure the Tank:	43
Step 2 - Set the Units of Measurement:	44
Step 3 - Set the Sensor Height (4mA):	45
Step 4 - Set the Fill-Height (20mA):	46
Step 5 - Set the Range (Maximum Range):	47
Step 6 - Set the Dead Band:	48
Step 7 - Check the Echo Curve:	49

Section Six :	50
Section Seven Process Adjustments:	51
Process Adjustments Overview:	51
Fast Filling or Emptying of Liquid:	52
Liquid Requiring First Echo Adjustment:	53
Liquid Surface is Turbulent or Agitated:	54
Foam on the Surface of the Liquid:	55
Liquids with Low Dielectric:	56
Sensor Installed in a Stand Pipe or Sight Glass:	57
Section Eight Advanced Adjustments:	58
Advanced Adjustments Overview:	58
4-20mA Reverse Output:	59
Fail-Safe Output:	60
Minimum Current Output:	61
HART® Operation Mode:	62
Create a New False Echo Curve:	63
Update an Existing False Echo Curve:	64
Section Nine Troubleshooting:	65
Troubleshooting Overview:	65
Measurement Status:	66
Peak Values:	67
Simulation:	68
First Echo Adjustment:	69
Echo Curve Zoom:	70
False Echo Curve Delete:	71
Reset:	72

Section Ten Appendix:	73
Configuration Menu:	73
Empty Configuration:	74
Full Configuration:	74
Medium:	75
Liquid Medium:	75
Solids Medium:	76
Low Dielectric Medium:	77
Dampen:	77
Scaled Units:	78
Range:	78
Dead Band:	78
Display Menu:	79
Display Value:	79
LCD Contrast:	79
Diagnostics Menu:	80
Peak Values:	80
Measurement Status:	80
Echo Curve:	81
Simulation:	81
Service Menu:	82
False Echo:	83
Output Settings:	83
Reset:	84
Units of Measurement:	84
Language:	84
HART® Operational Mode:	84
Information:	85
Factory Settings:	86
User Configuration:	86
Troubleshooting:.....	87
Warranty:	88

SENSOR MODELS

Offered in eight different models, EchoPro® is an intrinsically safe, two-wire, pulse radar level sensor that provides a continuous 4-20 mA current output that's proportional to the liquid level in a tank or sump. Make sure that the model purchased is appropriate for your application.

Series	Max. Range	Beam Angle	Material	Mounting	FCC Compliance	Application
LR11	32.81' (10m)	22°	PFA	1-1/2" NPT	Part 15.209, Class A	Corrosive liquids under simple process conditions
LR16	98.42' (30m)	18° (2" horn)	316L SS	1-1/2" NPT	Part 15.209, Class A	Storage tanks & process tanks under difficult process conditions
		12° (3" horn)			Part 15.256, Class B	
		8° (4" horn)			Part 15.256, Class B	
LR21	65.61' (20m)	12° (3" Flange)	316L SS with PTFE cover	3" ANSI flange	Part 15.256, Class B	Aggressive liquids under extremely difficult process conditions
		8° (4" flange)		4" ANSI flange		
LR26	114.83' (35m)	20°	316L SS with PTFE cover	4" ANSI flange 6" ANSI flange	Part 15.209, Class A	Storage tank & process tanks under extremely difficult process conditions
LR31	98.42' (30m)	12°	PA66	Bracket or top mounted (1") conduit	Part 15.256, Class B	Water processing, lift stations, storm water and sump process conditions

OPERATING PRINCIPLE

The sensor emits a microwave pulse from its antenna, which travels at the speed of light to the surface of the medium below. A portion of that energy reflects off the medium and returns to the antenna. The time gap between energy emission and receipt is called the “time of flight”, and is proportional to the distance between the medium surface and the sensors measurement location, as at the bottom of the antenna. The sensor measures the time of flight and translates this value into a continuous 4-20mA signal output that’s proportionate to level within a defined measurement span.

FEATURES

- Easy configuration with LCD push button display module
- Adjustable loop fail-safe, no change, 20.5 mA, 22 mA
- Small 12” (30.48cm) dead band enables full tank measurement
- Recognition, storage and deletion of false echo signal returns

BENEFITS

- Unaffected by physical process and environmental conditions
- Ideal for applications with higher temp, pressure, foam, vapor and vacuum
- Strong signal penetrability with minimal attenuation over distance

LIMITATIONS (FACTORS THAT COULD INFLUENCE PERFORMANCE)

- Air particulates with a high dielectric constant value such as lead or ferroalloy
- Highly dense air particulates that attenuate microwave emission and receipt
- Material build-up on the antenna that degrades microwave emission and receipt
- Mediums that have an extremely low dielectric constant value with little reflectivity

SPECIFICATIONS

Measurement Range: LR11:..32.81 feet (10m) LR16: 98.42 feet (30m)
 (maximum) LR21: 65.51 feet (20m) LR26: 114.83 feet (35m)
 LR31:..98.42 feet (30m)

Dead Band: 12" (30.48cm) / Factory Set -
Note: Can be lowered to 2" from the bottom of the antenna

Measurement Accuracy: LR11:..±5 mm LR16: ±3mm
 (see charts on pages 8 & 9) LR21: ±3mm LR26: ±10mm
 LR31: ±3mm

Display Resolution: 1 mm

Frequency Range: 26 GHz: LR11, LR16, LR21 & LR31 series
 6.3 GHz: LR26 series only

Measurement Interval: About 1 sec (dependent on configuration settings)

Adjustment Time: About 1 sec (dependent on configuration settings)

Beam Angle: LR11: 22° LR21: 12° - 3" ANSI Flange
 LR16: 18° - 2" (48mm) Horn 8° - 4" ANSI Flange
 12° - 3" (78mm) Horn LR26: 20°
 8° - 4" (98mm) Horn LR31: 12°

Process Connection: LR11: 1-½" NPT LR26: 4" ANSI Flange
 LR16: 1-½" NPT 6" ANSI Flange
 LR21: 3" ANSI Flange LR31: Bracket or top
 4" ANSI Flange mount (1") NPT

Material:

Series	LR11	LR16	LR21	LR26	LR31
Flange	N/A		316L SS		N/A
Enclosure	316L SS				PA66 (Nylon)
Antenna	PFA	316L SS	316L SS with PTFE Cover		PA66 (Nylon)
Extension	PBT-FR	N/A			
Seal	Viton®				
Seal Ring	Silicone (between housing and cap)				
Window	Polycarbonate				N/A
Ground Terminal	Stainless Steel				
Bracket	N/A				316 SS

Weight:	LR11: 2.20 lbs (1kg)	LR16: 4.41 lbs (2kg)
Depends on process connection size and housing configuration	LR21: 6.61 lbs (3kg)	LR26: 6.61 lbs (3kg)
Temperature (Process):	LR11: F: -40° to 266° C: -40° to 130°	LR16: F: -76° to 302° C: -60° to 150°
	LR21: F: -40° to 302° C: -40° to 150°	LR26: F: -40° to 266° C: -40° to 130°
	LR31: F: -40° to 212° C: -40° to 100°	
Temperature compensation:	Automatic	
Temperature (Storage):	F: -40° to 176° C: -40° to 80°	
Relative Humidity:	<95%	
Process Pressure:	LR11: -14.5 to 43.5 psi (-1 to 3 bar)	LR16: -14.5 to 150 psi (-1 to 10.3 bar)
	LR21: -14.5 to 72.5 psi (-1 to 5 bar)	LR26: -14.5 to 580 psi (-1 to 40 bar)
	LR31: Atmospheric	
Vibration Proof:	Mechanical vibration 10m/s, 10m ² /s, 10 -150 Hz	
Output:		
Signal Output:	4-20mA with HART® 7.0	
Signal Invert:	4-20mA, 20-4 mA	
Resolution:	1.6µA	
Fail-Safe Setting:	20.5mA, 22mA or no change	
Integration Time:	0-40 sec, adjustable	
Load Resistance:	See chart below	

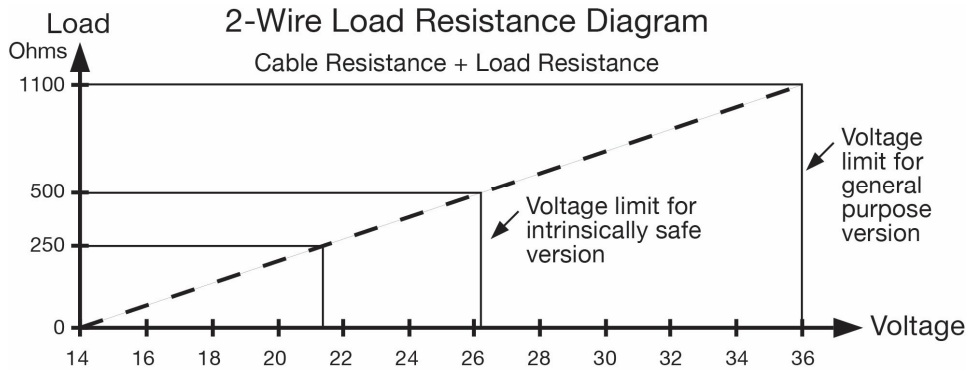

Power:

Power Supply: 24 VDC (21.6 to 26.4 VDC) the same two-wire connection cable carries power supply and current signal.

Power Consumption: 22.5mA maximum

Ripple Allowed:

<100Hz: <1V

100 to 100 KHz: <10mV

Enclosure Rating: LR11, LR16, LR21, LR26: IP67 (NEMA 6)

LR31: IP68 (NEMA 6P)

Cable Connection: Standard 2-wire shielded cable with earth ground wire and outside diameter of 5-9mm is recommended.

Cable Length (LR31 only): 10m (32.8') standard /
15m (49.2') maximum length between LR31 and LR98

Cable Entry/Plug: LR11, LR16, LR21, LR26:..... One cable entry (1/2" NPT with adapter, M20x1.5)
LR31:.....One cable entry (1" NPT)

Accuracy Charts

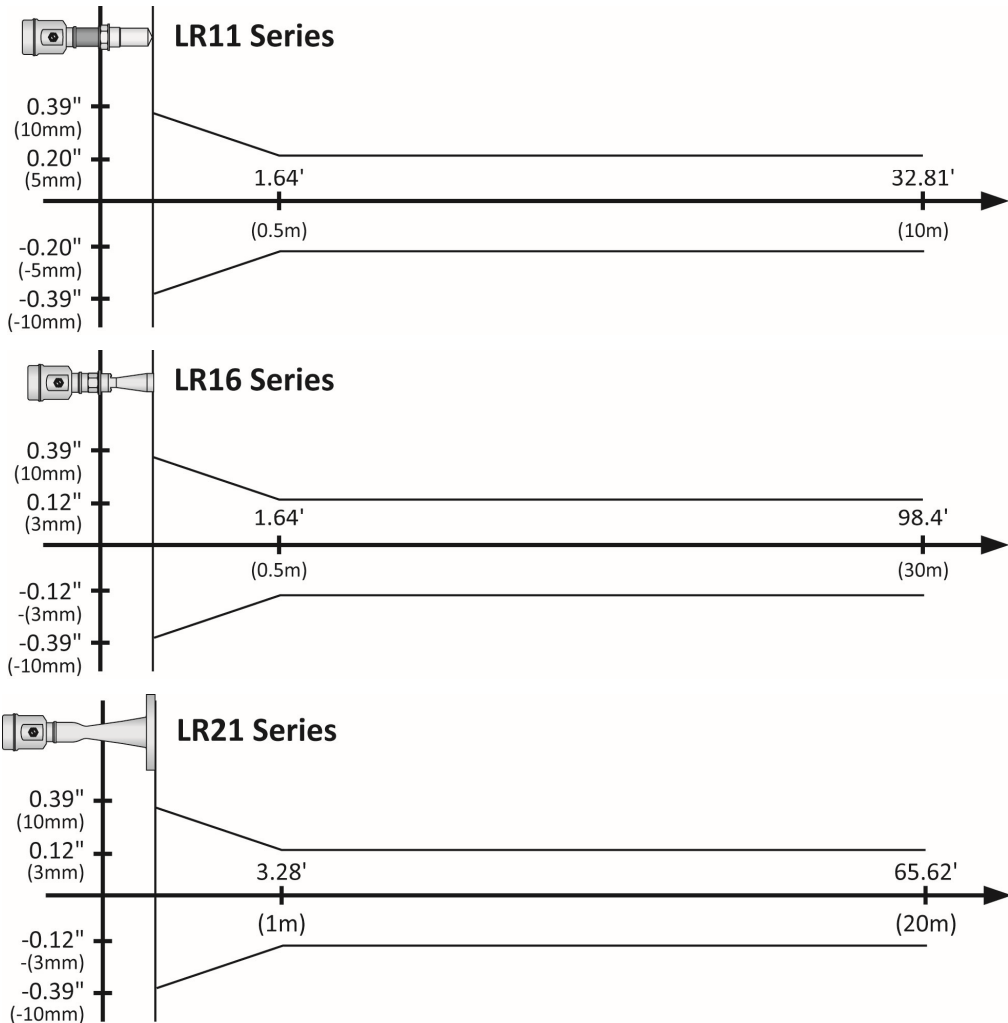

Accuracy Charts

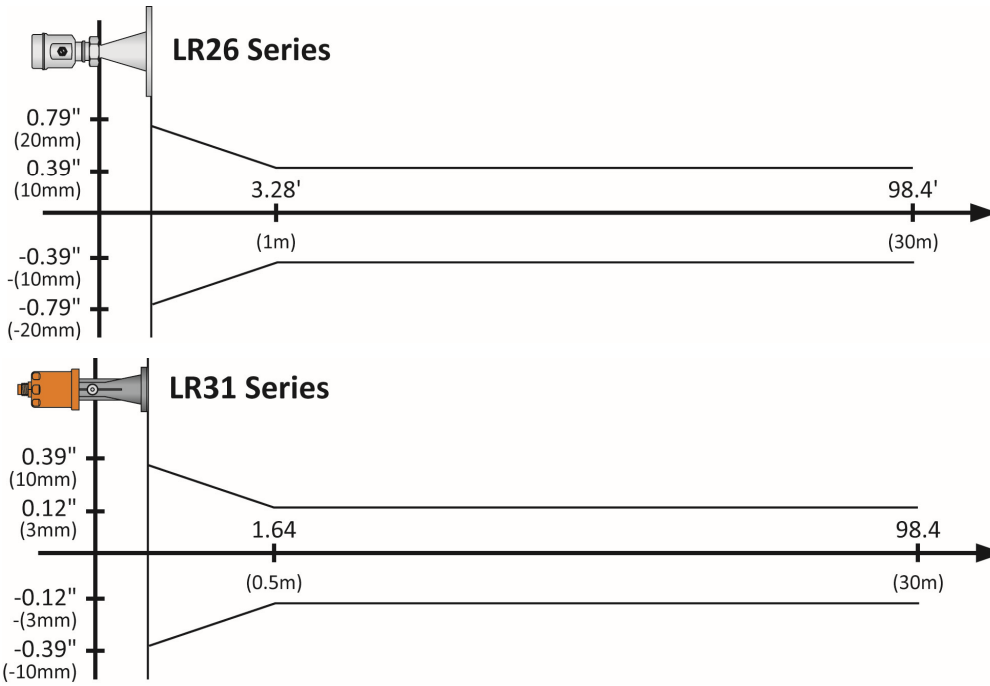

Communication: FCC (US)
 Part 15.209, Class A: LR11, LR16 (2" horn) and LR26 series can only be installed on metal or reinforced concrete tanks.
 Part 15.256, Class B: LR16 (3" & 4" horn), LR21 & LR31 series can be installed on any tank material.

Compliance: The equipment complies with the following standards:

- IEC: 60079-0:2011 & 60079-11:2011
- EN: 60079-0:2012 & 60079-11:2012
- RoHS

This product is an intrinsically safe version (Ex ia IIC T6...T3 Ga) with stainless steel housing. All electric circuits are fully encapsulated in the internal enclosure, where no conductive parts will contact with flammable gas. Two-Wire system in service, the power of the product is from safety barrier limited at:

U_i = 26.4V	I_i = 114mA	P_i = 0.752W	C_i = 0	L_i = 51µH
------------------------------	------------------------------	-------------------------------	--------------------------	-----------------------------

A safety barrier should be placed between power source and instrument for intrinsically safe version. All connection cables must be screened with maximum length of 500m (stray capacitor ≤ 0.1 µF/Km and stray inductance ≤ 1mH/Km). The level measurement instrument must be connected to ground potential and unapproved supplemental devices are not allowed to use.

Application conditions:

Temp. class	Maximum process temperature			
	T6	T5	T4	T3
Ta (max.)				
60 °C	60°C	95°C	130°C	180°C
65 °C	-----	70°C	130°C	180°C
70 °C	-----	70°C	130°C	180°C
85 °C	-----	-----	130°C	180°C

Pressure for electronic housing 11.5 psi (80kPa) to 16.0 (110kPa).

Ambient temperature: T6: -20°C ≤ Ta ≤ 60°C
 T5: -20°C ≤ Ta ≤ 70°C
 T4: -20°C ≤ Ta ≤ 85°C
 T3: -20°C ≤ Ta ≤ 85°C

Cable Connection:

- This product shall be used with certified IECEx and ATEX cable glands and block plugs. The cable used for "ia" terminal shall be in compliance with the requirement of EN/IEC 60071-14 clause. Additional requirements for types of protection "I" – intrinsic safety. It's installing and operation instructions should be observed if other cable glands are used.
- Care should be taken with the cable glands which should be matched to the cable used outside diameter property; see mark of cable gland for the outer diameter of being cable used.
- In order to ensure the required minimum degree of protection, the bolts of cable glands, blanking plug and relevant sealing bolts are to be tighten down.

INTRINSICALLY SAFE CONTROL DRAWING 301901:

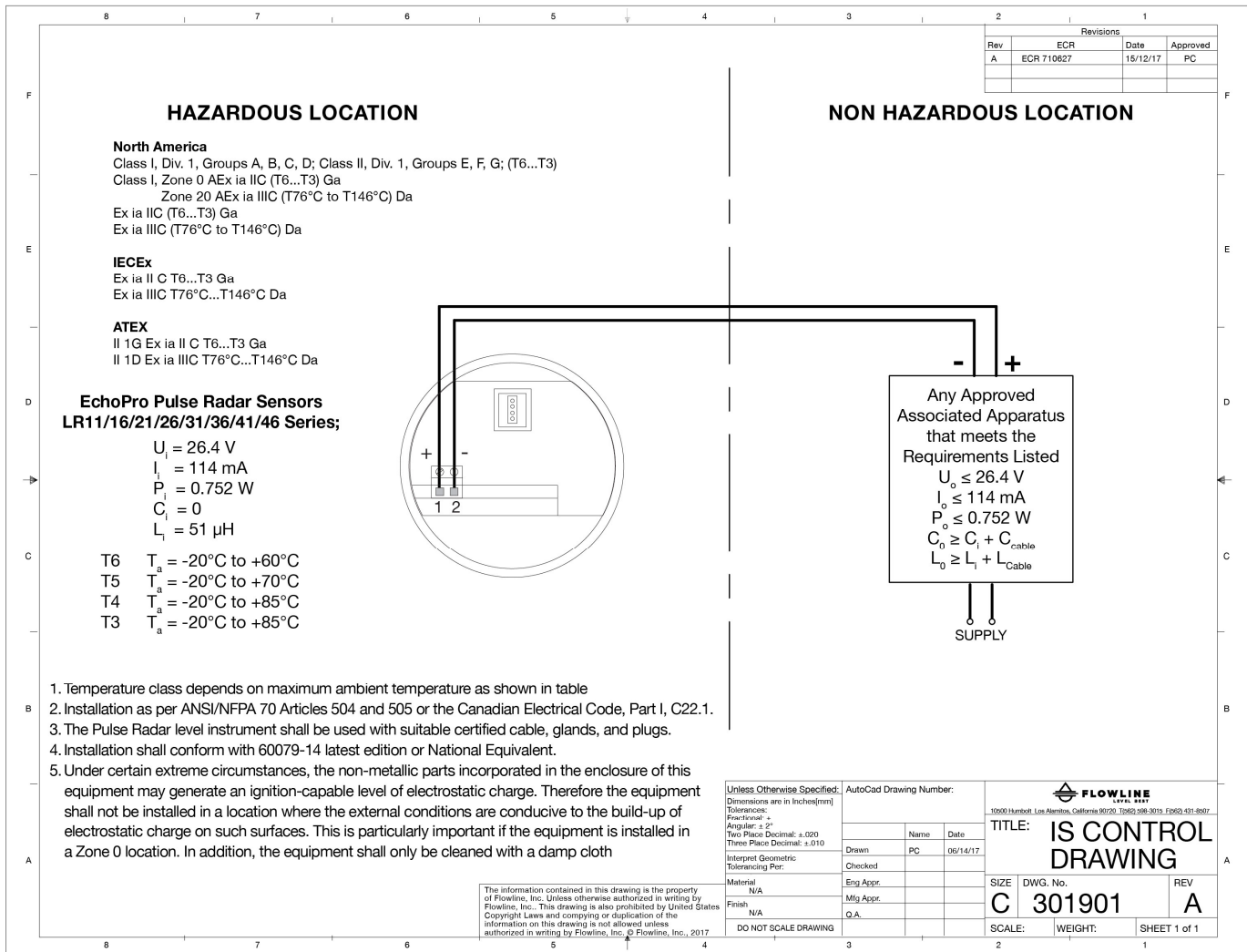

Intrinsically Safe Approvals:

Intrinsic Safe:

North America: Class I, Div.1, Groups A, B, C, D; Class II, Div.1, Groups E, F, G; (T6...T3)
 (cCSA_{US}) Class I, Zone 0 AEx ia IIC (T6...T3) Ga
 Zone 20 AEx ia IIIC (T76°C to T146°C) Da

Ex ia IIC (T6...T3) Ga
 Ex ia IIIC (T76°C to T146°C) Da

ATEX: II 1G Ex ia II C T6...T3 Ga;
 (TUV) II 1D Ex ia IIIC T76°C...T146°C







IECEX: Ex ia II C T6...T3 Ga;
 (TUV) Ex ia III C T76°C...T146°C Da





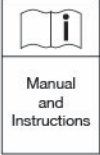

General: CE, RoHS

Intrinsically Safe Entity Parameters:

$U_i = 26.4\text{V};$ $I_i = 114\text{ mA};$ $P_i = 0.752\text{W};$ $C_i = 0;$ $L_i = 51\text{ }\mu\text{H}$

LABELS FOR INTRINSIC SAFETY

 <p>Equipment: EchoPro™ Radar Level Instrument Type: LRXX-XXXX-XX Ex Marking:  II 1G Ex ia II C T6...T3 Ga  II 1D Ex ia III C T76°C...T146°C Da Ex ia II C T6...T3 Ga Ex ia III C T76°C...T146°C Da Class I, Div 1, Groups A, B, C & D; Class II, Groups E, F & G; Class I, Zone 0 IIC & Zone 20 Group IIC Explosion Certificate: TÜV 16 ATEX 7834 X IECEx TUR. 16.0014X Ui = 26.4V li = 114mA Pi = 0.752W Ci = 0 Li = 51uH Output: (4...20) mA HART two-wire Ambient Temperature: See manual and instructions WARNING POTENTIAL ELECTROSTATIC CHARGING HAZARD: SEE INSTRUCTIONS</p>  			This device complies with Part 15 of the FCC Rules. Operation is subject to the following two conditions: (1) this device may not cause harmful interference, and (2) this device must accept any interference received, including interference that may cause undesired operation FCC ID: 2ACQELRXX
Address: Flowline Inc. 10500 Humbolt Street Los Alamitos, CA 90720			

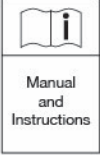
 <p>Equipment: EchoPro™ Radar Level Instrument Type: LRXX-XXXX-XX Ex Marking:  II 1G Ex ia II C T6...T3 Ga  II 1D Ex ia III C T76°C...T146°C Da Ex ia II C T6...T3 Ga Ex ia III C T76°C...T146°C Da Class I, Div 1, Groups A, B, C & D; Class II, Groups E, F & G; Class I, Zone 0 IIC & Zone 20 Group IIC Explosion Certificate: TÜV 16 ATEX 7834 X IECEx TUR. 16.0014X Ui = 26.4V li = 114mA Pi = 0.752W Ci = 0 Li = 51uH Output: (4...20) mA HART two-wire Ambient Temperature: See manual and instructions WARNING POTENTIAL ELECTROSTATIC CHARGING HAZARD: SEE INSTRUCTIONS</p>  			This device complies with Part 15 of the FCC Rules. Operation is subject to the following two conditions: (1) this device may not cause harmful interference, and (2) this device must accept any interference received, including interference that may cause undesired operation FCC ID: 2ACQELRYY
Address: Flowline Inc. 10500 Humbolt Street Los Alamitos, CA 90720			

Part Number Label

P/N	LRXX-XXXX
S/N	YYMMDD-000000

DIMENSIONS

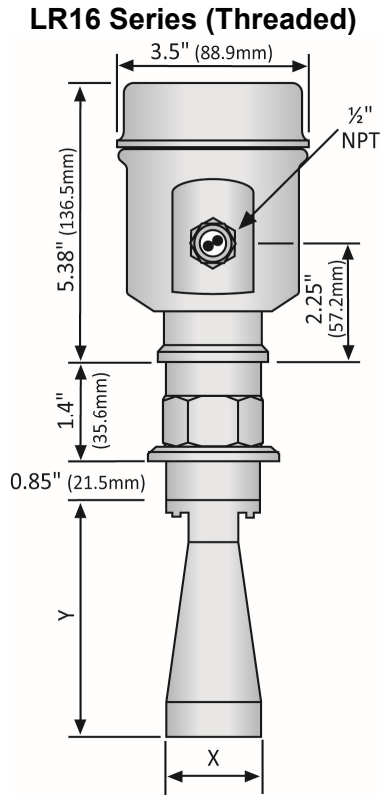
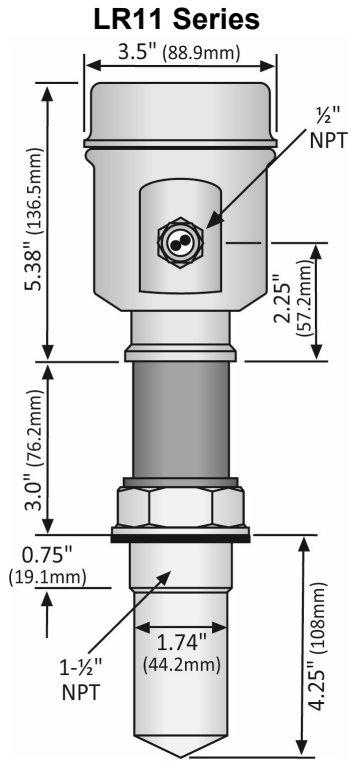

LR16 Series (Threaded)
Antenna Dimensions

Diameter (X)	Length (Y)
2" (48mm)	5.51" (140mm)
3" (78mm)	8.94" (227mm)
4" (98mm)	11.34" (288mm)

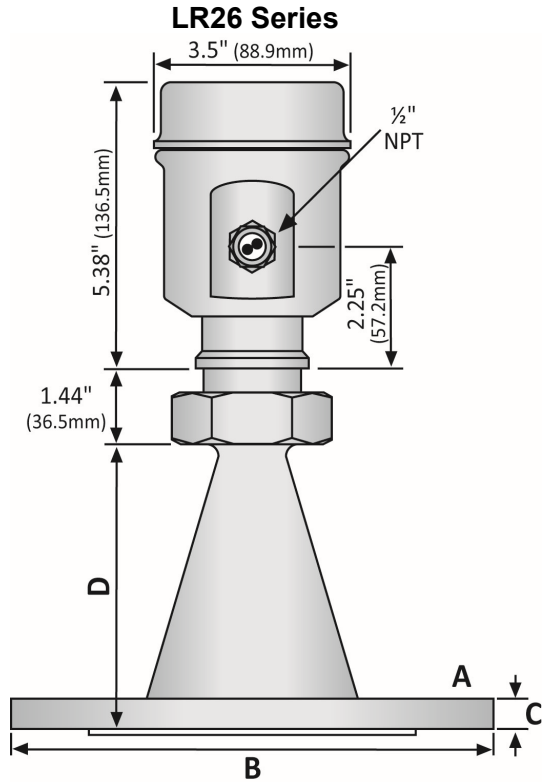
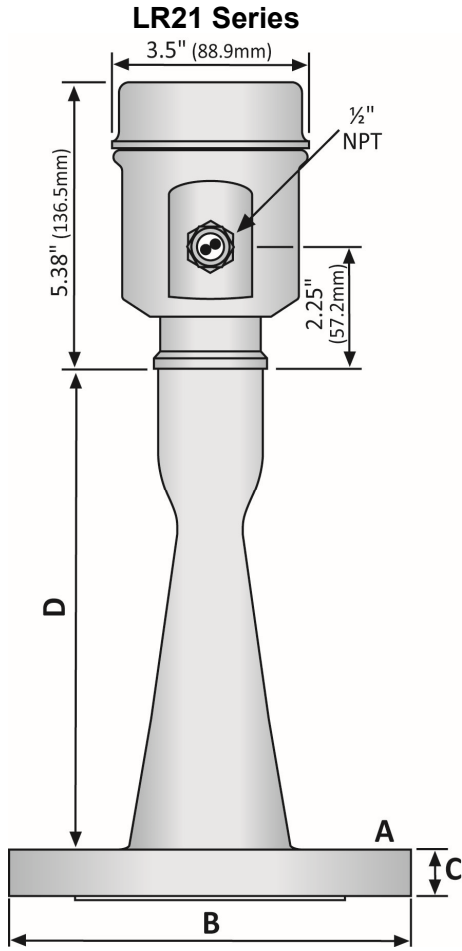

LR21 Series Flange / Antenna

Dimensions

Flange (A)	Diameter (B)	Thickness (C)	Length (D)
3" ANSI	7.5" (190.5mm)	0.88" (22.3mm)	9" (228.6mm)
4" ANSI	9.0" (228.6mm)	0.88" (22.3mm)	10.5" (266.7mm)

LR26 Series Flange / Antenna

Dimensions

Flange (A)	Diameter (B)	Thickness (C)	Length (D)
4" ANSI	9.0" (228.6mm)	0.57" (14.5mm)	5.71" (145mm)
6" ANSI	11.0" (279.4mm)	0.63" (16.1mm)	9.75" (247.7mm)

LR31 Series Bracket (Top View)

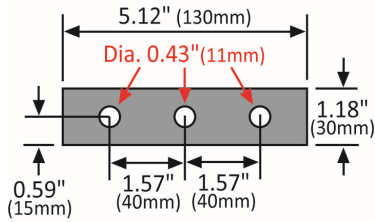

LR31 Series (Side View A)

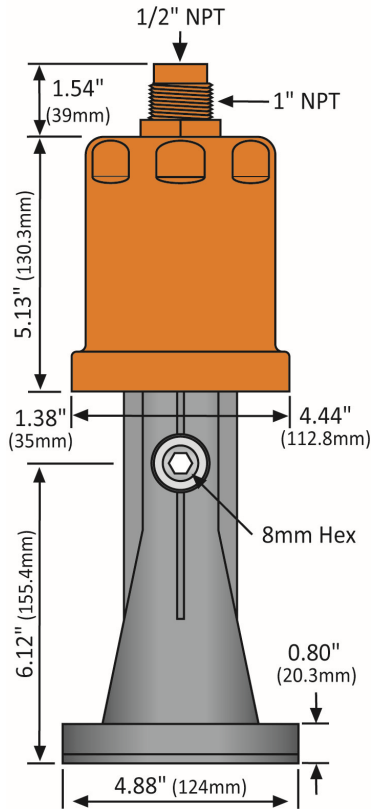

LR31 Series (Side View B)

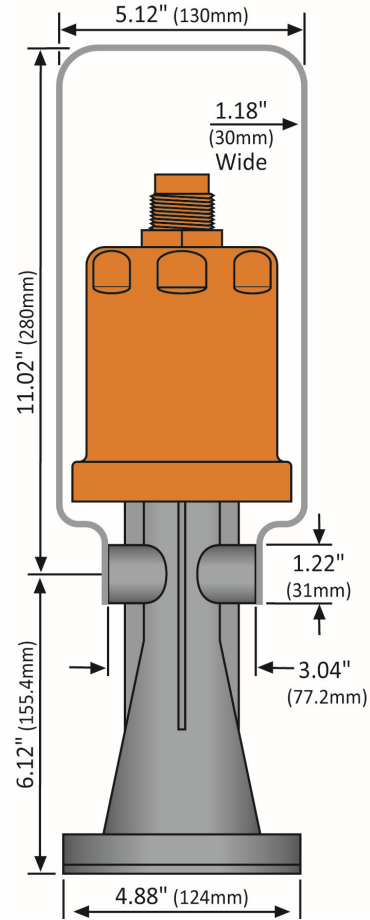

LR98 Series Display (Front View)

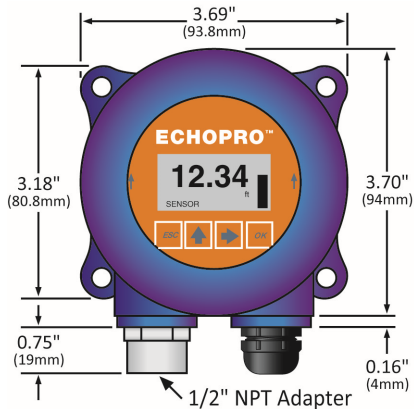

LR98 Series Display (Bottom View)

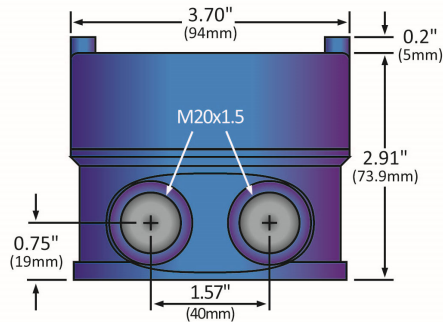

LR98 Series Display (Side View)

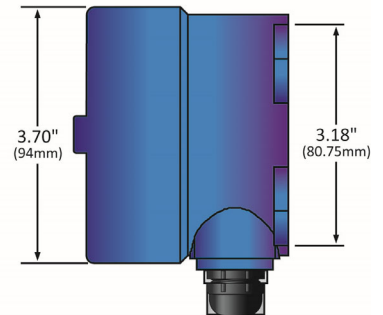

Note: Both conduit ports feature M20x1.5 threads. LR98 ships with Liquid Tight Fitting (LM90-1051) and LR97-S003 Adapter (1/2" FNPT to M20x1.5). Use the adapter to interface to any 1/2" MNPT connection.

SAFETY PRECAUTIONS

▲ **About this Manual:** PLEASE READ THE ENTIRE MANUAL PRIOR TO INSTALLING OR USING THIS PRODUCT. This manual includes information on the EchoPro® Radar Level Transmitter from FLOWLINE. Please refer to the part number located on the sensor label to verify the exact model, which you have purchased.

▲ **User's Responsibility for Safety:** Flowline manufactures a broad range of level sensing technologies. While each of these sensors is designed to operate in a wide variety of applications, it is the user's responsibility to select a sensor model that is appropriate for the application, install it properly, perform tests of the installed system, and maintain all components. The failure to do so could result in property damage or serious injury.

▲ **Proper Installation and Handling:** Only professional staff should install and/or repair this product. Never over tighten the sensor within the fitting. Always check for leaks prior to system start-up.

▲ **Wiring and Electrical:** A supply voltage of 16 to 26 VDC is used to power the EchoPro®. Electrical wiring of the sensor should be performed in accordance with all applicable national, state, and local codes.

▲ **Material Compatibility:** The enclosure is made of either Aluminum or 316 Stainless Steel (refer to sensor part number). The antenna is made of Stainless Steel (SS), Polytetrafluoroethylene (PTFE), Perfluoroalkoxy Alkane (PFA) or Nylon (PA66) with a Viton seal (refer to sensor part number). Make sure that the model, which you have selected, is chemically compatible with the application media.

▲ **Enclosure:** The sensor housing is liquid-resistant, but is not designed to be operational when immersed (LR31 series is designed for submersion but will not provide a true level reading while submersed). Mount the sensor in such a way that the enclosure and antenna do not come into contact with the application media under normal operational conditions. The enclosure has a cover that provides access to the push button display module and terminal strip for wiring. To open the enclosure, you will need to twist the cover counter-clockwise. Before closing the enclosure, make sure that the enclosure gasket is properly seated, and that any conduit fittings, cable connectors or plugs are installed correctly and sealed. **Note:** *If using the Flowline LM90-1001 (liquid tight fitting) on the ½" conduit, the cable minimum is 0.170" (4.3mm) and the maximum is 0.450" (11.4mm).*

▲ **Make a Fail-Safe System:** Design a fail-safe system that accommodates the possibility of sensor and/or power failure. FLOWLINE recommends the use of redundant back-up systems and alarms in addition to the primary system.

▲ **Flammable, Explosive or Hazardous Applications:** *EchoPro® is approved for use within intrinsically safe applications and is intended for use within classified hazardous environments.*

▲ **Handling Static-Sensitive Circuits and Devices:** When handling the instrument, the technician should follow the below guidelines to reduce the possibility of an electrostatic charge build-up on the technician's body from being transferred to the electronic part. Always touch a known good ground source before handling a part. This should be repeated while handling the part and more frequently after sitting down from a standing position, sliding across the seat or walking a distance. Avoid touching electrical terminals of the part unless making connections. DO NOT open the unit cover until it is time to work on the part.

SETUP OVERVIEW

The below highlights the initial steps in setting up your sensor for operation.

1. Part Number (Section Two)

1. Prior to purchasing the sensor, you may have submitted a Level Application Questionnaire (www.flowline.com/LAQ), which based upon the information provided, may have resulted in a suggested part number. Where so, confirm that the suggested part number matches the part number of the purchased sensor. If any of the above does not match and/or meet your application requirements, please contact your distributor.

2. Install Sensor (Section Three)

1. Information on the location and mechanical installation of the sensor.

3. Wire Sensor (Section Four)

1. Information on the electrical wiring and power requirements of the sensor.

4. Basic Configuration Using Display (Section Five)

1. Begin by measuring the tank for all key dimensions.
 - a. Accuracy in measurement will result in accuracy of sensor performance.
2. Set the Units of Measurement for the sensor.
 - a. Units can be configured in basic engineering units of length: Feet, Meters
3. Set the Sensor Height for the sensor in the tank.
 - a. This is the 4mA setting for the output.
4. Set the Fill-Height for the sensor in the tank.
 - a. This is the 20mA setting for the output.
5. Set the Max. Range (Maximum Range or MaxR) for the sensor in the tank.
 - a. The sensor will ignore any echo signal returns beyond this setting.
6. Set the Dead Band (Minimum Range or MinR) for the sensor in the tank.
 - a. The sensor will ignore any echo signal returns closer than this setting.
7. Check the Echo Curve
 - a. This is a quick check to determine if the sensor is reading the correct level.

Note: When configuring EchoPro®, choose either the Push Button or WebCal® method. WebCal® can be used to enter or adjust the Sensor Height, Fill-Height, Maximum Range or Dead Band settings only. Either method will accomplish the goal of sensor configuration. Changes to the configuration can be made using the alternative method. When beginning with one method, it is recommended to complete the configuration before using the other method for any other adjustments.

5. Basic Configuration Using WebCal® (Section Six)

1. Install WebCal® software
2. Measure the Tank
 - a. Accuracy in measurement will result in accuracy of sensor performance.
3. Sensor Configuration
4. Dimensional Entry
5. Tank Level Confirmation
6. Write to Unit
7. Check EchoCurve
 - a. This is a quick check to determine if the sensor is reading the correct level.

6. Process Adjustments (Section Seven)

1. Information on OPTIONAL adjustments for specific process conditions that may exist in your application.
 - a. Fast filling or emptying of liquid.
 - b. Liquid surface is turbulent or agitated.
 - c. Foam on the surface of the liquid.
 - d. Sensor installed in a still well or sight glass.
 - e. Powder or Dust is present.
 - f. Low Dielectric material
 - g. Large Angle of Repose with the material

7. Advanced Adjustments (Section Eight)

1. Reverse 4-20 mA Output
 - a. Reverses the current output from 4mA @ bottom and 20mA @ top of tank to 20mA @ bottom and 4mA @ top of the tank.
2. Fail-Safe Setting
 - a. Allows for the presetting of the current output when a sensor failure occurs.
3. Minimum Current Setting
 - a. Sets the minimum current output for the sensor.
4. HART® Operation Mode
 - a. Sets the address for HART® output upon activating the multi-drop setting.
5. Create a New False Echo Curve
 - a. A method to map out false echo signal returns within the tank.
6. Update an Existing False Echo Curve
 - a. A method to update false echo signal returns for a section of the tank that was not exposed during the creation of the original False Echo Curve.

8. Troubleshooting (Section Nine)

1. Measurement Status
 - a. Determines the measurement reliability and general status of the sensor.
2. Peak Values
 - a. Displays the lowest and highest level height that the sensor has measured in distance (d).
3. Simulation
 - a. Simulates and helps to determine the accuracy and linearity of the sensor.
4. First Echo Adjustment
 - a. Increases or decreases the strength of the first echo signal return.
5. Echo Curve Zoom In
 - a. A method to zoom in and view the Echo Curve over a specific range.
6. False Echo Curve Delete
 - a. A method to delete a previously saved False Echo Curve from memory.
7. Reset
 - a. A method to reset the sensor's configuration to the original factory setting.

PART NUMBER

Prior to purchasing the sensor, you may have submitted a Level Application Questionnaire (www.flowline.com/LAQ). Based upon the information provided, it may have resulted in a suggested part number. Where so, confirm that the suggested part number matches the part number of the sensor. The part number can be found on the outside label of the sensor as shown below:



The part number will indicate the size and type of mounting fitting required for installing the sensor. Refer to the below part number description for specific information. If any of the above does not match and/or meet your application requirements, please contact your distributor.

LR11 - 5 4 2 1 -

Housing Material

5 - Stainless Steel Intrinsically Safe

Process Connection

4 - PFA - 1 1/2" NPT

Approval

2 - ATEX / IECEx / HazLoc

Output

1 - 4-20 mA

FOB

0 0 Without FOB
0 1 With FOB

LR16 - 5 0 2 1 - 0 -

Housing Material

5 - Stainless Steel Intrinsically Safe

Process Connection

0 - Thread 1 1/2" NPT

Approval

2 - ATEX / IECEx / HazLoc

Output

1 - 4-20 mA

Antenna Shape

2 - 2" (48mm) Horn
3 - 3" (78mm) Horn
4 - 4" (98mm) Horn

Flange Size

0 - Threaded Connection

FOB

0 0 Without FOB
0 1 With FOB

LR21 - 5 3 2 1 - 0 -

Housing Material

5 - Stainless Steel Intrinsically Safe

Process Connection

3 - ANSI Flange

Approval

2 - ATEX / IECEx / HazLoc

Output

1 - 4-20 mA

Flange Size

3 - 3" Flange (ANSI / DIN)

4 - 4" Flange (ANSI / DIN)

FOB

0 0 Without FOB

0 1 With FOB

LR26 - 5 3 2 1 - 0 -

Housing Material

5 - Stainless Steel Intrinsically Safe

Process Connection

3 - ANSI Flange with PTFE insert

Approval

2 - ATEX / IECEx / HazLoc

Output

1 - 4-20 mA

Flange Size

4 - 4" Flange (ANSI / DIN)

6 - 6" Flange (ANSI / DIN)

FOB

0 0 Without FOB

0 1 With FOB

LR31 - 0 0 2 1 - 1 0 -

Housing Material

0 -PA66 / Nylon

Mount

0 -Bracket

Approval

2 - ATEX / IECEx / HazLoc

Output

1 - 4-20 mA

Remote Display / Configuration Tool

-With Remote Display

1 0 /Configuration Tool

FOB

0 0 -without FOB

0 1 -With FOB

INSTALLATION REQUIREMENTS

EchoPro® measures the distance between the sensor and the liquid surface below. Typically, all measurements from the sensor originate from the bottom of the antenna. Refer to the Measurement Reference Chart to determine the location where measurement originates on your sensor. To ensure reliable measurement, adhere to the following minimum installation requirements:

- 1) There are no obstructions between the bottom edge of the installed antenna and the surface of the liquid below including ladders, walls, tank seams, liquid inflows, rails, other sensors, mixer blades, heating coils, pumps, struts or apparatus. **Note:** *Additionally, when the sensor transmits a microwave pulse, the RF signal spreads in a conical shape (determined by its beam angle) over distance.* Refer to the Beam Angle Chart to determine, what if any, additional measurement space is required to be free of such obstacles. If such items are present, then a False Echo Curve configuration must be conducted (Section Seven).
- 2) The sensor must be installed with the antenna perpendicular to the surface of the media.
- 3) The sensor must be installed with a distance ≥ 19.7 " (500mm) from the side wall of the tank.
- 4) The media level must not be allowed to enter into the dead band (blanking zone) of the sensor.
- 5) The sensor installation must be done in accordance with relevant local or federal safety regulations.
- 6) The sensor must be connected to electrical ground.
- 7) Do not use the housing to screw the sensor into the installation fitting (LR11 & LR16 Series).
 - a) Applying force against the housing to tighten may damage the sensor.
- 8) Make sure that any part of the sensor as exposed to the application, specifically any portion installed within the tank, are suitable for the process.
 - a) Consider any effects from the application temperature, pressure or media.

FCC CONFORMITY

- ⚠ This instrument complies with Part 15 of the FCC Rules. Operation is subject to the following two conditions: (1) this instrument may not cause harmful interference, and; (2) this instrument must accept any interference received, including interference that may cause undesired operation.
- ⚠ Changes or modifications not expressly approved by the manufacturer could void the user's authority to operate the equipment.
- ⚠ **Warning:** User must maintain a safe zone distance of at least 20cm (7.87") from the antenna.
- ⚠ **Note: LR11, LR16 (2" horn) & LR26 series:** This equipment has been tested and found to comply with the limits for a Class A digital device, pursuant to part 15 of the FCC Rules. These limits are designed to provide reasonable protection against harmful interference when the equipment is operated in a commercial environment. This equipment generates, uses, and can radiate radio frequency energy and, if not installed and used in accordance with the instruction manual, may cause harmful interference to radio communications. Operation of this equipment in a residential area is likely to cause harmful interference in which case the user will be required to correct the interference at their own expense.
 - This equipment is not allowed to be connected to public utility power lines.
- ⚠ **NOTE: LR16 (3" & 4" horn), LR21 & LR31 series:** This equipment has been tested and found to comply with the limits for a Class B digital device, pursuant to Part 15 of the FCC Rules. These limits are designed to provide reasonable protection against harmful interference in a residential installation. This equipment generates uses and can radiate radio frequency energy and, if not installed and used in accordance with the instructions, may cause harmful interference to radio communications. However, there is no guarantee that interference to radio and television reception, which can be determined by turning the equipment off and on, the user is encouraged to try to correct the interference by one or more of the following measures:
 - Reorient or relocate the receiving antenna.
 - Increase the separation between the equipment and the receiver.
 - Isolate the equipment to an outlet different from where the receiver is connected.
 - Consult the dealer or an experienced technician for help.

LR16 ANTENNA PREPARATION

The LR16 Series antenna (only) may be removed from the sensor to allow a flange or reducer bushing accessory to be attached to the 1 1/2" NPT mounting threads and/or, the antenna may be inserted from within the inside of the tank through the bottom of an existing fitting (where the base of the antenna is too wide to pass through the fitting from the top). Referencing the illustrations, follow the below steps to disconnect, mount and reattach the antenna.

- 1) Loosen and remove the four (4) socket screws using a 3mm Allen wrench.
- 2) Carefully remove the antenna. **Note:** Do not remove or damage the plastic cone (microwave RF emitter) within the antenna socket.
- 3) Insert the antenna through the bottom of the fitting. **Note:** If doing so from the inside of the tank, make sure to secure it, so as to prevent the antenna from falling into the tank.
- 4) Connect the sensor to the antenna socket and reattach the four (4) screws using a 3mm Allen wrench.
- 5) Attach the sensor to the fitting as necessary.

Add a Flange

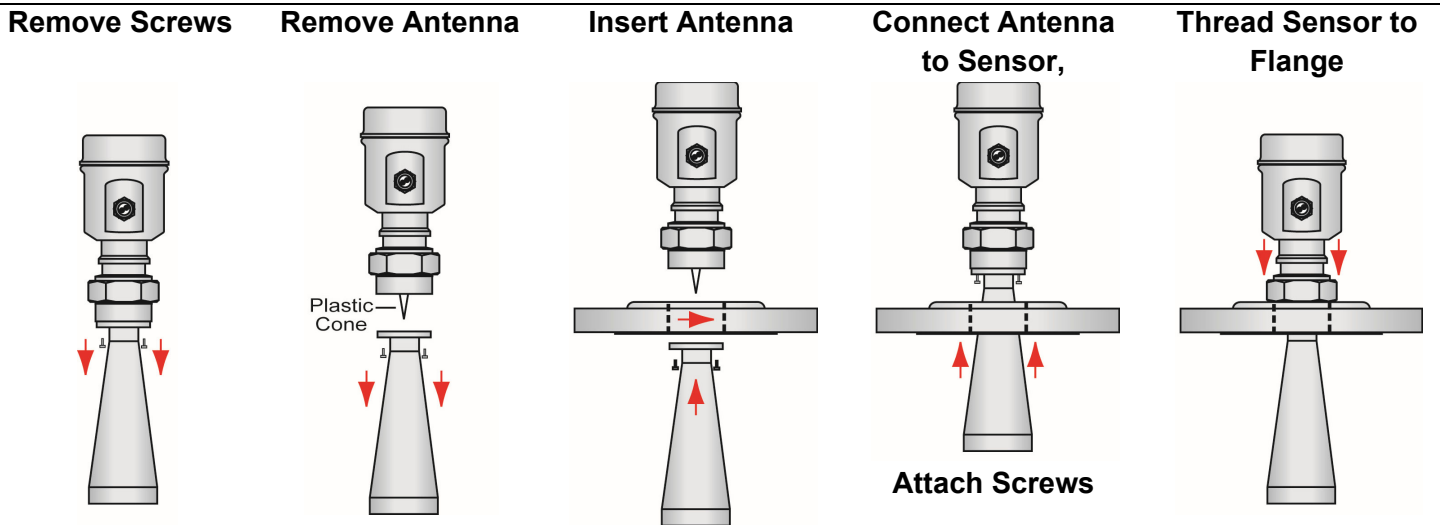

Add a Reducer Bushing

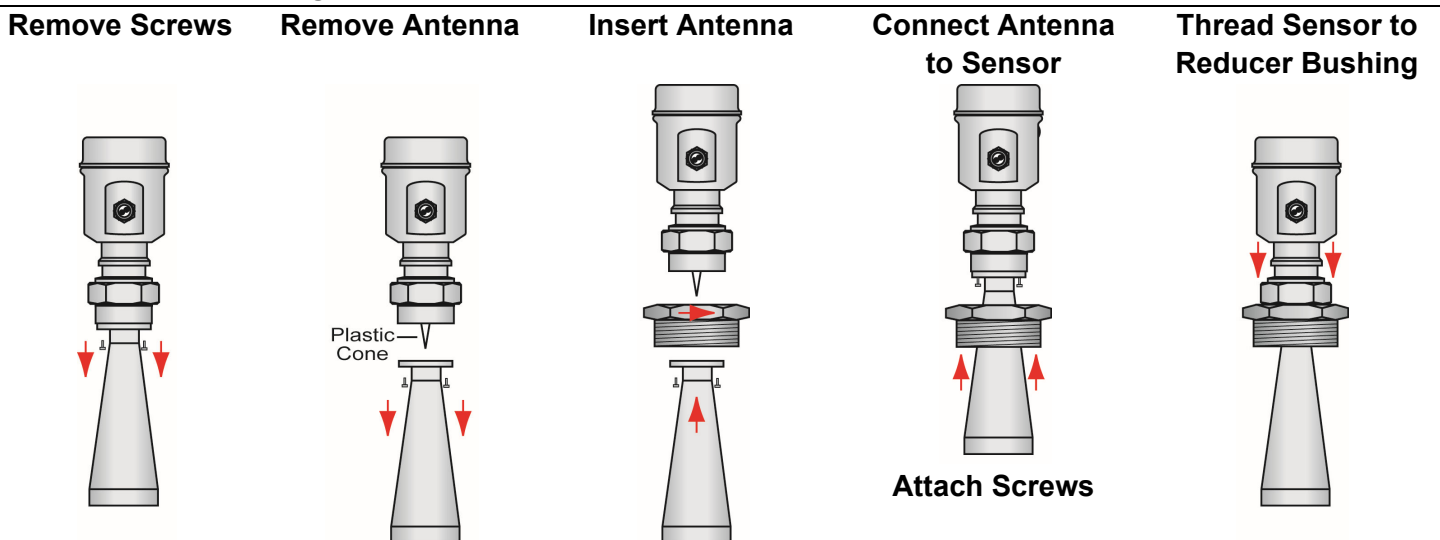

MOUNTING POSITION

The minimum distance (independent of beam angle) that the sensor can be mounted next to the straight side wall of the tank is 19.7" (500mm) as measured from the sensor centerline to the side wall. If you are **not** able to install the sensor more than 19.7" (500mm) away from the side wall, or if there is material build up on the side wall (within the beam angle), perform a False Echo Curve during initial configuration.

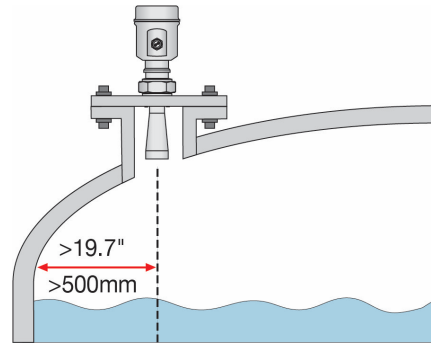

Avoid mounting the sensor in the center of a dome top tank. The center of such a tank will multiply the echoes, making sensor operation difficult.

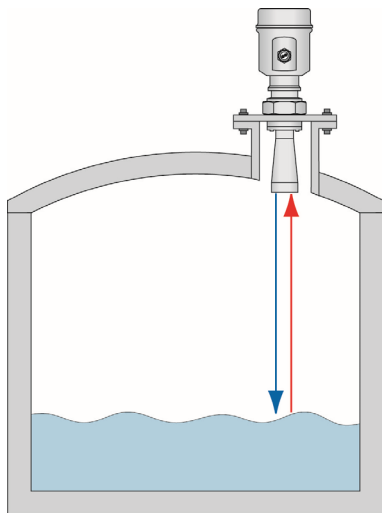

←←← Correct Mounting ←←←
Sensor mounted off center in a dome top tank.

→→→ Incorrect Mounting →→→
Sensor mounted in the center of a domed top tank resulting in multiple echoes.

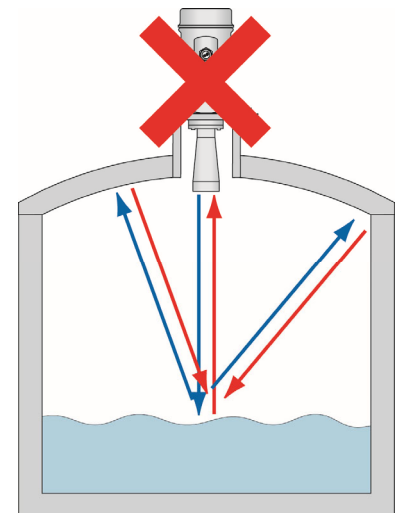

In cone bottom tanks, it can be advantageous to mount the sensor in the center of the tank, making it possible for the sensor to measure closer to the bottom of the tank. If the sensor is mounted over an angled bottom, and the level drops below the angle, the echo will be deflected away from the sensor, resulting in poor operation. The sensor can be mounted over an angled bottom as long as the level is maintained within the straight side wall so the sensor will receive echo returns.

Center Mount - Correct

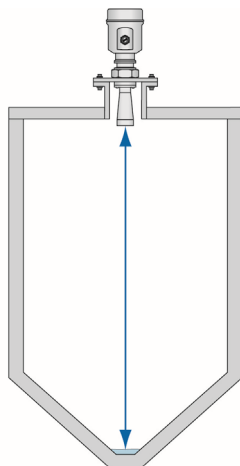

Level Below Side Wall - Incorrect

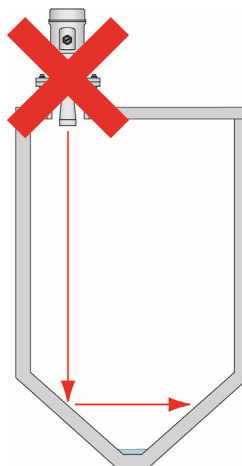

Level Above Side Wall - Correct

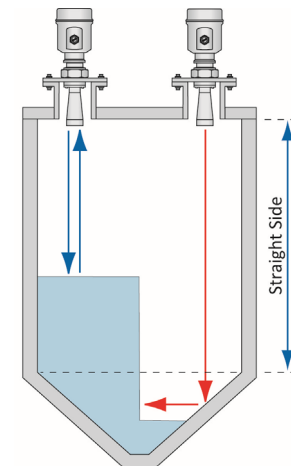

MOUNT THE SENSOR PERPENDICULAR TO THE LIQUID LEVEL

Always mount the sensor perpendicular to the surface of the media. This will enable the return echoes to reach the sensor. Mounting the sensor off-axis will result in weak return echoes or no return echoes, depending on the degree of angle.

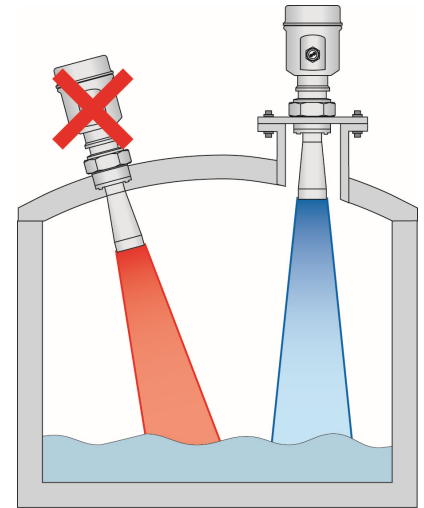

CONSIDER THE DEAD BAND

The sensor has a dead band (blanking distance) of 12" (30.48mm) as its default. The dead band can be lowered to within 2" of the bottom of the antenna (*consult with factory*). This is an up close distance where the sensor is not able to measure the level within this range. Typically, the measurement location for the sensor is at the bottom of the antenna. When identifying a location for sensor installation, take into account the length of the antenna combined with the dead band of the sensor.

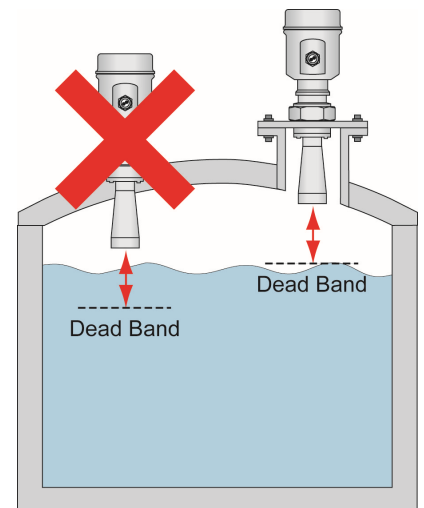

AVOID CONDENSATION IN THE CONDUIT

You can give your instrument additional protection against moisture penetration by leading the conduit connection or cable downward in front of the cable entry. Condensation in the conduit will therefore not enter the sensor's enclosure.

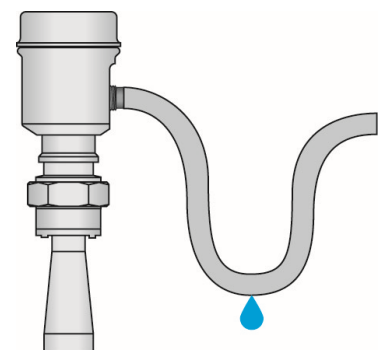

AVOID OBSTRUCTIONS IN THE BEAM PATH

Do not mount the sensor in or above the fill stream, other equipment (ladders, pumps, mixers) or structures within the beam path of the sensor. Such items can create false echo returns and prevent the actual level from being identified by the sensor. Find a location where the sensor has a clear view of the media surface. If your tank has other equipment near or within the beam path of the sensor, a False Echo Curve should be performed during initial configuration.

←←← Fill Stream Mounting ←←←

Mounting on left incorrectly positions sensor above the tank fill stream inlet.

Mounting on right is correct as the sensor has an unobstructed view to the media level below.

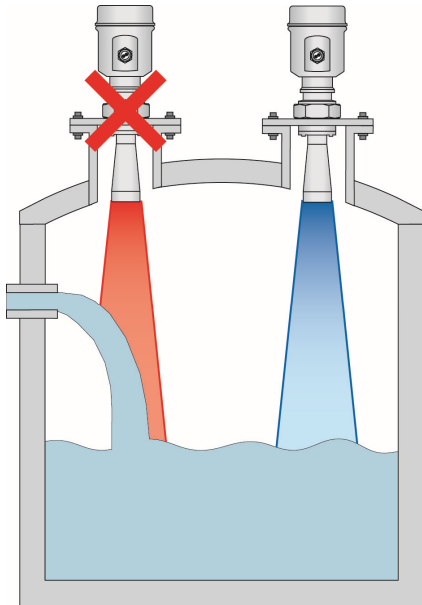

→→→ Reflector Installation →→→

Mounting on left incorrectly allows the sensor to receive false echo returns from the step.

Mounting on right has an angled baffle-board mounted over the step, which prevents the false echo from returning to the sensor. As such, the sensor only receives correct echo returns from the media level.

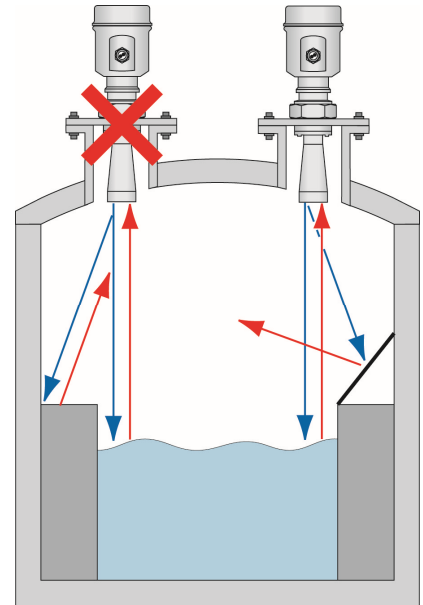

FLANGE RISER INSTALLATION

When installing the sensor on a flange with a riser (or any fitting that is tall and narrow), the antenna must protrude at least 0.4" (10mm) from the bottom of the riser.

Antenna Extension

LR16 Series Shown

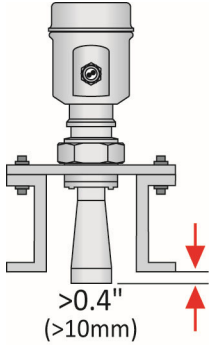

The sensor can be installed within the riser as long as the media has a strong reflective property (dielectric constant) providing a strong echo return. The below information describes the maximum distance that the antenna can be recessed within a riser based on the diameter and height of the fitting.

LR16 Series Shown

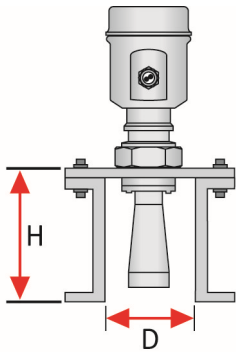

LR21 Series Shown

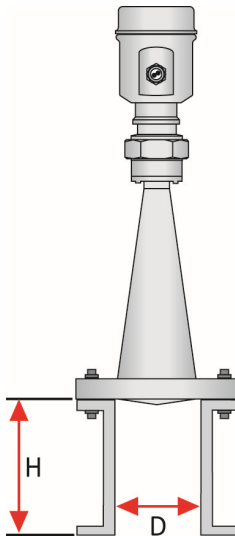

LR11 & LR16 Series

Diameter (D)	Height (H)
1-1/2"	7.9" (200mm)
2" (50mm)	9.8" (250mm)
3" (80mm)	11.8" (300mm)
4" (100mm)	19.7" (500mm)
6" (150mm)	31.5" (800mm)

LR21 & LR26 Series

Diameter (D)	Height (H)
3" (80mm)	11.8" (300mm)
4" (100mm)	19.7" (500mm)
6" (150mm)	31.5" (800mm)

AGITATOR OR MIXER

If there are agitators or mixers in the tank, the sensor should be mounted as far away from the blades as possible. Once the installation is complete, a False Echo Curve should be performed while the agitator or mixer is in motion to map out and eliminate false echo returns from the blades. If significant foam and/or agitation exist within the application, a stand-pipe installation should be considered.

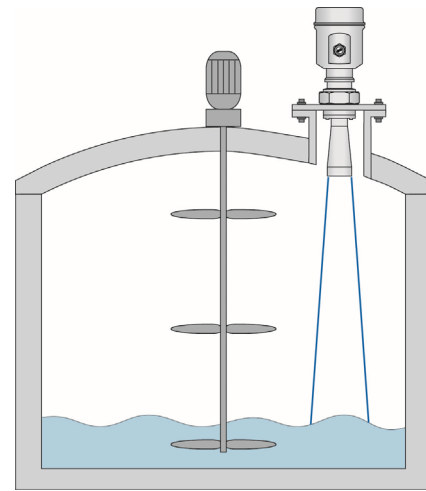

BEAM ANGLE

The emitted microwave pulse will expand along its specified beam angle for the entire height of the tank. Place the sensor so that objects will not interfere with the beam path underneath the sensor. The beam angle is a function of the sensor Series and antenna length (where variable). Verify the beam angle specification of your sensor and reference the below charts to determine the amount of free measurement space required under the installed sensor.

Beam Angle	8°	12°	18°	20°	22°	24°
Height	Diameter	Diameter	Diameter	Diameter	Diameter	Diameter
10'	1.40'	2.10'	3.17'	3.53'	3.89'	4.25'
20'	2.80'	4.20'	6.34'	7.05'	7.78'	8.50'
30'	4.20'	6.31'	9.50'	10.58'	11.66'	12.75'
40'	5.59'	8.41'	12.67'	14.11'	15.55'	17.00'
50'	6.99'	10.51'	15.84'	17.63'	19.44'	21.26'
60'	8.39'	12.61'	19.01'	21.16'	23.33'	25.51'
70'	9.79'	14.71'	22.17'	24.69'	27.21'	29.76'
80'	11.19'	16.82'	25.34'	28.21'	31.10'	34.01'
90'	12.59'	18.92'	28.51'	31.74'	34.99'	38.26'
100'	13.99'	21.02'	31.68'	35.27'	38.88'	42.51'

Beam Angle	8°	12°	18°	20°	22°	24°
Height	Diameter	Diameter	Diameter	Diameter	Diameter	Diameter
5m	0.70m	1.05m	1.58m	1.76m	1.94m	2.13m
10m	1.40m	2.10m	3.17m	3.53m	3.89m	4.25m
15m	2.10m	3.15m	4.75m	5.29m	5.83m	6.38m
20m	2.38m	4.20m	6.34m	7.05m	7.78m	8.50m
25m	3.50m	5.26m	7.92m	8.82m	9.72m	10.63m
30m	4.20m	6.31m	9.50m	10.58m	11.66m	12.97m

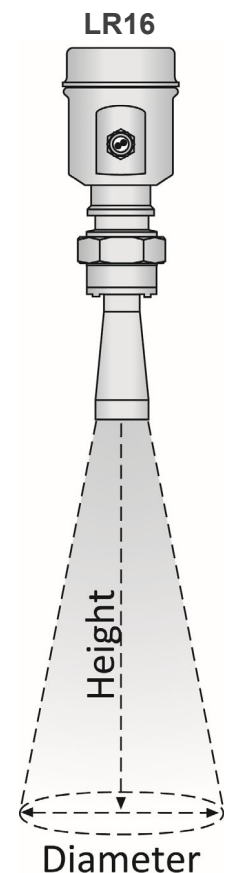

STAND PIPE INSTALLATION

To avoid issues from turbulence, substantial foam or other equipment in the sensors beam path, install the sensor within a stand pipe (still well). A stand pipe installation can be used with media where the dielectric constant as low as 1.9. **Note:** *The use of a stand pipe is not recommended with media that significantly coat or scale. As a rule, if the inside wall of the tank has material build-up, then the inside of the stand pipe will also have build-up that will affect the sensor's operation.* When installing a sensor in a stand pipe, follow the below guidelines:

- 1) The Full Configuration setting (20mA) must be below the upper vent hole and the bottom of the antenna.
- 2) The Empty Configuration setting (4mA) is typically placed at or near the bottom of the stand pipe.
- 3) The Stand Pipe function must be activated. It can be found under Medium in the Configuration Menu. The inner diameter of the stand pipe must be entered within this function.
- 4) It is recommended to perform a False Echo Curve when the sensor is installed in a stand pipe.

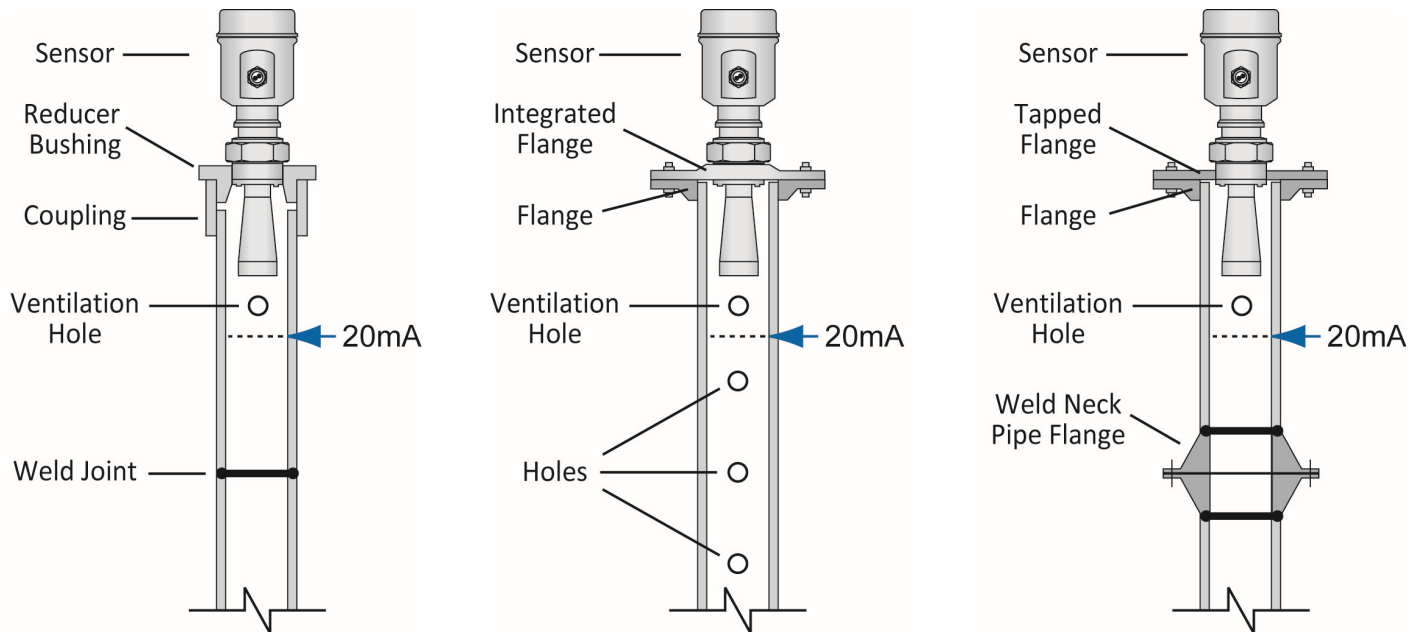

STAND PIPE CONSTRUCTION

- 1) The stand pipe material must be **metal** with a smooth inner pipe wall. The minimum pipe size is dependent upon the Series and antenna length. The LR11 and LR16 sensor can be applied in pipe sizes $\leq 3"$ (76.2mm).
- 2) Any welded joint must be straight with a gap size $\leq 1/254"$ (0.1 mm).
- 3) Flanges should be welded to the stand pipe tube.
- 4) In the case of a pipe extension with a welded neck flange or pipe collar, make sure the inner surfaces are aligned and accurately joined together.
- 5) When securing the pipe to the tank, **do not** weld through the pipe wall.
 - a) Roughness on the inside caused by unintentional pipe penetration should be removed.
 - b) Not doing so will cause strong false echo returns and encourage buildup within the pipe.
- 6) The diameter of any holes along the pipe must be $\leq 1/5"$ (5 mm).
 - a) The top ventilation hole must be above the Full Configuration setting (20mA).
 - b) The holes must be vertically aligned on one side of the pipe with all burrs removed.
- 7) The number of holes does not matter. The inner diameter of the pipe cannot change over the entire pipe length.

BYPASS INSTALLATION

An alternative to a stand pipe is installing the sensor within a bypass chamber mounted outside of the tank. Bypass installations can avoid issues from turbulence, substantial foam or other equipment in the sensors beam path. **Note:** *The use of a bypass is not recommended with media that significantly coats or scales. As a rule, if the inside wall of the tank has material build-up, then the inside of the bypass chamber will also have build-up that will affect the sensor's operation.* When installing a sensor in a bypass, follow the below guidelines:

- 1) The Full Configuration setting (20mA) must be placed at or below the upper tank connection pipe.
- 2) The Empty Configuration setting (4mA) must be placed at or above the bottom tank connection pipe.
- 3) The Stand Pipe feature must be activated. It can be found under Medium in the Configuration Menu. The inner diameter of the sight glass must be entered within this function.
- 4) It is recommended to perform a False Echo Curve when the sensor is installed in a sight glass.

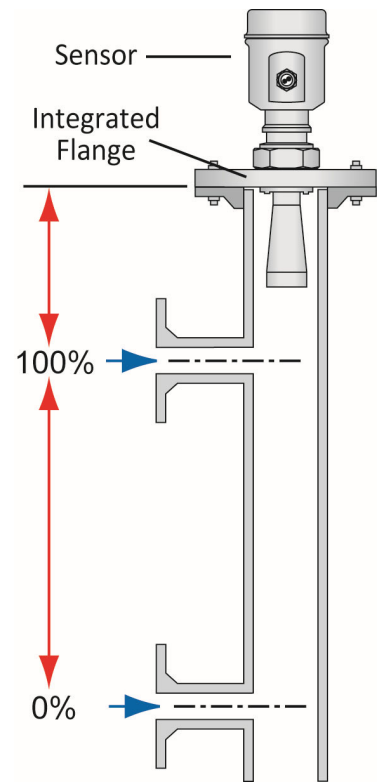

BYPASS CONSTRUCTION

- 1) The bypass material must be **metal** with a smooth inner pipe wall. The minimum pipe size is dependent upon the Series and antenna length. The LR11 and LR16 sensor can be applied in pipe sizes $\leq 3"$ (76.2mm).
- 2) There is a minimum distance $>11.8"$ ($>300\text{mm}$) between the bottom of the antenna and the top edge of the upper tank connection pipe.
- 3) Any welded joints must be straight with a gap size $\leq 1/254"$ (0.1 mm).
- 4) Flanges should be welded to the sight glass tube.
- 5) The inner diameter of the sight glass cannot change over the entire pipe length.

STAND PIPE / BYPASS PIPE SIZE VS. SERIES

Series	Minimum Pipe	Maximum Pipe
LR11: All	2"	3"
LR16: 2" Antenna	2"	8"
3" Antenna	3"	
4" Antenna	4"	
LR21: 3" Antenna	3"	8"
4" Antenna	4"	
LR26: 4" Antenna	4"	8"
6" Antenna	6"	
LR31: All	N/A	N/A

LR31 SENSOR INSTALLATION

The LR31 is unique within the EchoPro® sensor family. It is designed for use in water processing, lift stations, storm water, sump and environmental storage ponds/reservoirs, streams or dams, which require the sensor to be installed in locations that are often below grade where flooding is a possibility. The design of the sensor allows for the unit to be submersed. While the sensor will not be damaged while submersed, the sensor will not provide correct level readings when submersed. **Note:** Do not attempt to open the sensor housing. Doing so will damage the seal, allow moisture into the sensor, and cause a sensor failure. The sensor also features a submersion resistant 10m (32.8') cable and IP67 remote push button display module (LR98 described on the following page) through which the sensor can be configured and the level will be displayed.

Mount the Sensor Perpendicular to the Liquid Level

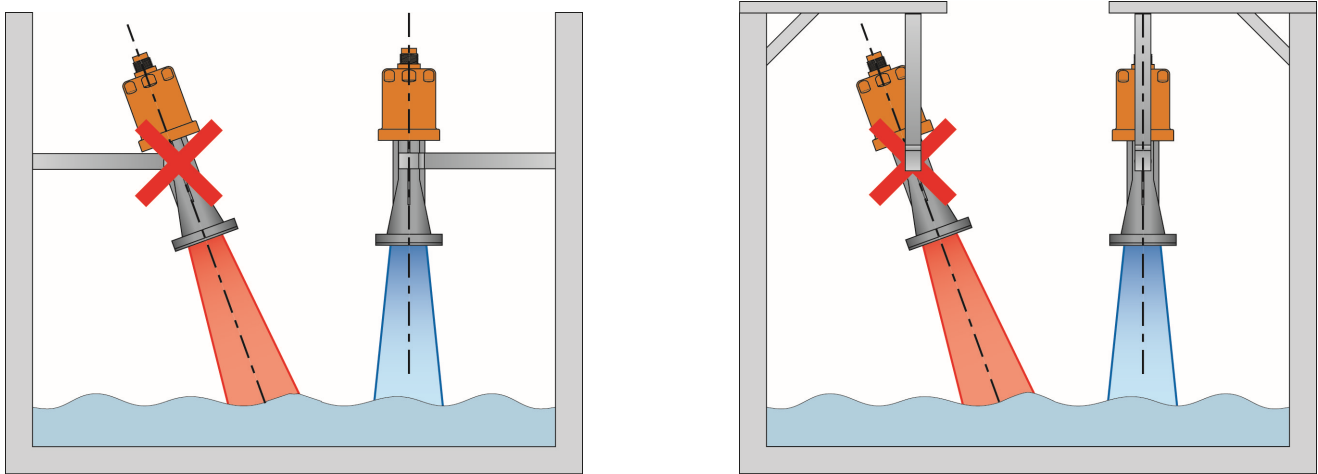

BRACKET OR CONDUIT MOUNT

Mounting from the bracket or from the 1" conduit connector are both acceptable mounting methods. The measurement location for all readings is located at the bottom of the sensor. Remember to take into account the installed insertion length of the sensor when calculating level height within the sump. **Note:** Never mount the sensor hanging from the cable. This type of installation will not secure the sensor, may damage the cable connection and will result in inconsistent level readings as the sensor sways.

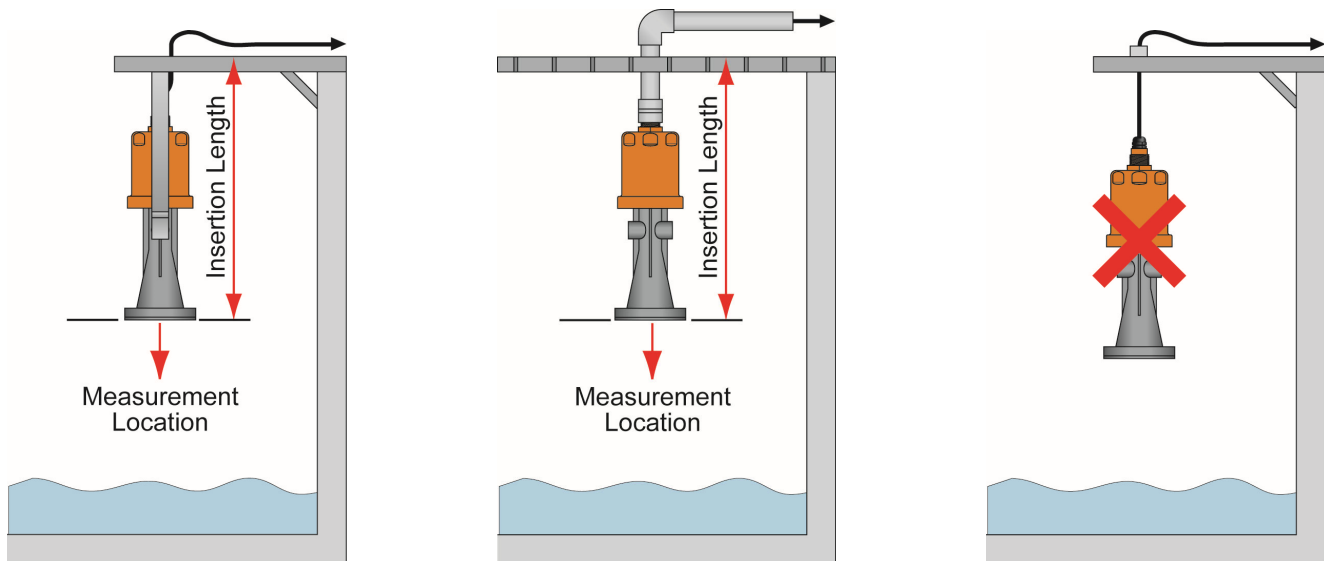

LR98 DISPLAY INSTALLATION

The LR98 is a wall / bulkhead mount IP67 remote push button display module that's used to configure and display level readings from the LR31 sensor. The LR98 should be mounted in a location where the display can be easily read. **Note:** The LR31 cable length is 32.8' (10m) which is also the maximum signal distance between the LR31 and LR98. Take that into account when selecting the LR98 mounting location and use the below drill-hole template for installing the display.

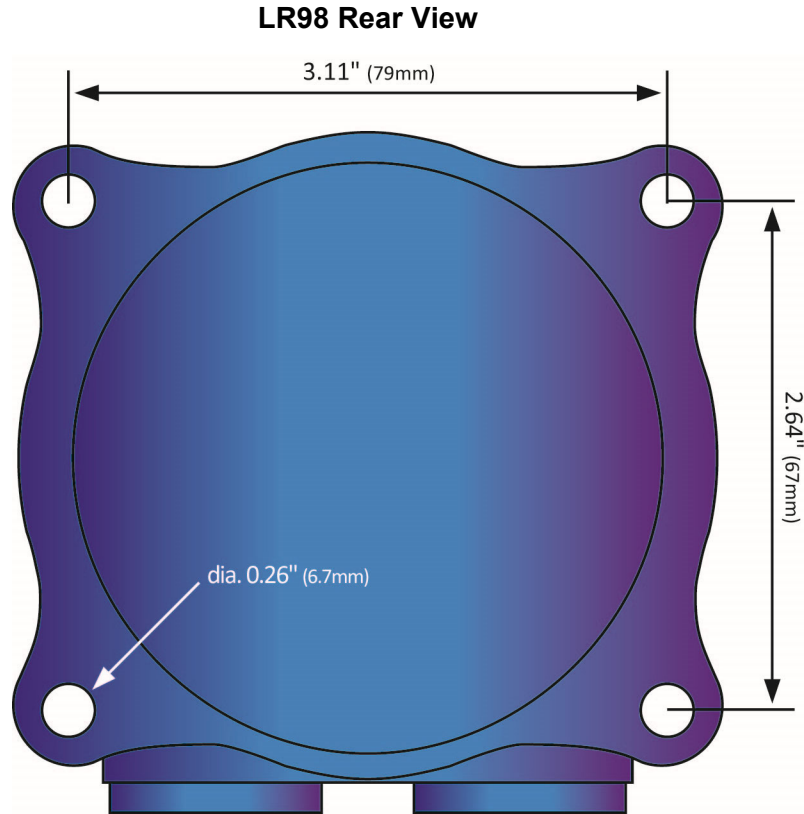

Note: Make sure that the LR98 display is mounted in an above grade location where it will not become submersed.

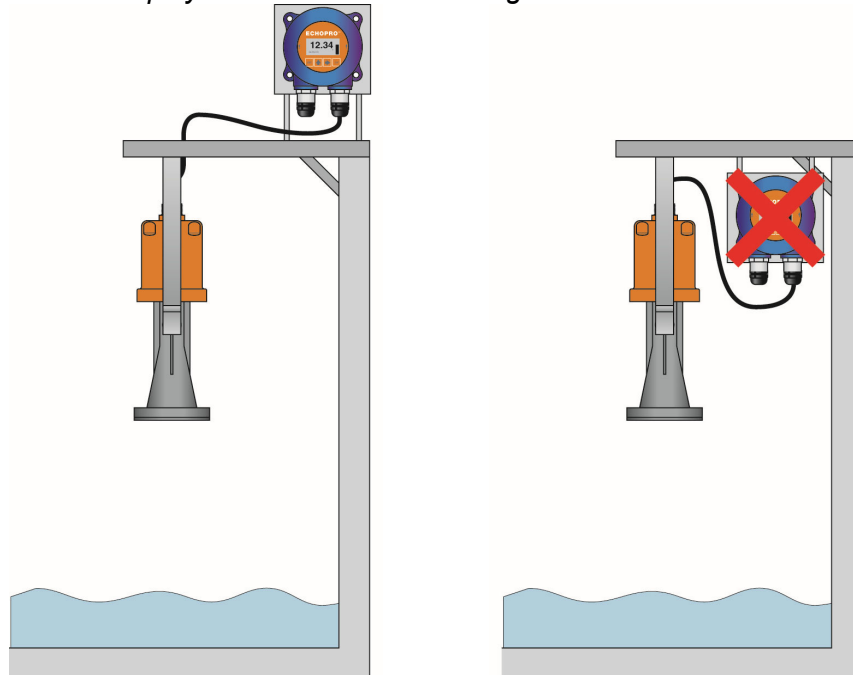

REMOVE THE DISPLAY

To access the terminal strip and conduit ports, you must remove the display. Gently twist the display counter-clockwise until you feel the display unlock from the housing. Next, lift the display from the housing to view the terminal strip and wire access ports. **Note:** This procedure applies to all sensors including the LR98 remote display for the LR31.

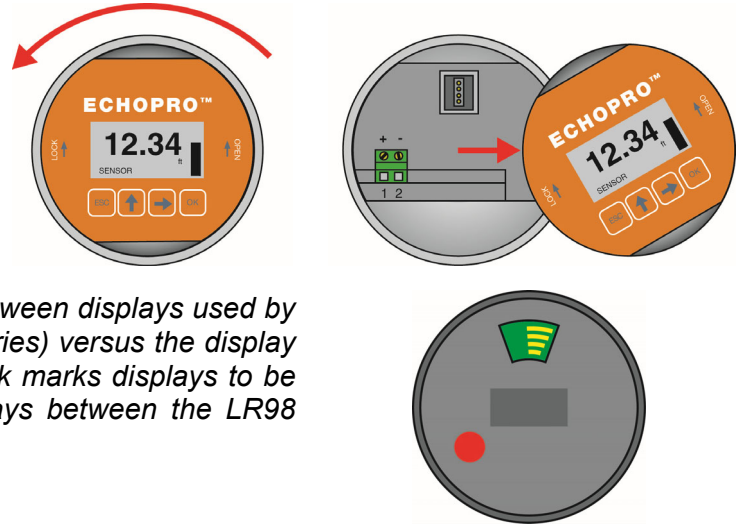

Note: There is an internal configuration difference between displays used by the EchoPro® sensors (LR11, LR16, LR21 & LR26 series) versus the display used with the LR98 series. A colored dot on the back marks displays to be used only with the LR98 series. Never swap displays between the LR98 series and other EchoPro® sensors.

SUPPLY VOLTAGE

The sensor power supply and current signal share the same two-wire shielded cable. The sensor supply voltage should never exceed 26.4 VDC. Always provide complete electrical and physical separation between the sensor supply circuit and the main circuit. **Note:** Remember that the output voltage of the power supply can be lower under nominal load (with a sensor current of 20.5 mA or 22 mA) and/or with the addition of other instruments placed within the circuit. If voltage spikes or surges are expected, adequate isolation protection must also be provided.

TERMINAL WIRING

The positive (+) and Negative (-) terminals are for connection to a 24 VDC power supply or to a 4-20 mA loop power source. The wire to the terminals can be extended up to 1,000 feet using 22 gauge or larger wire.

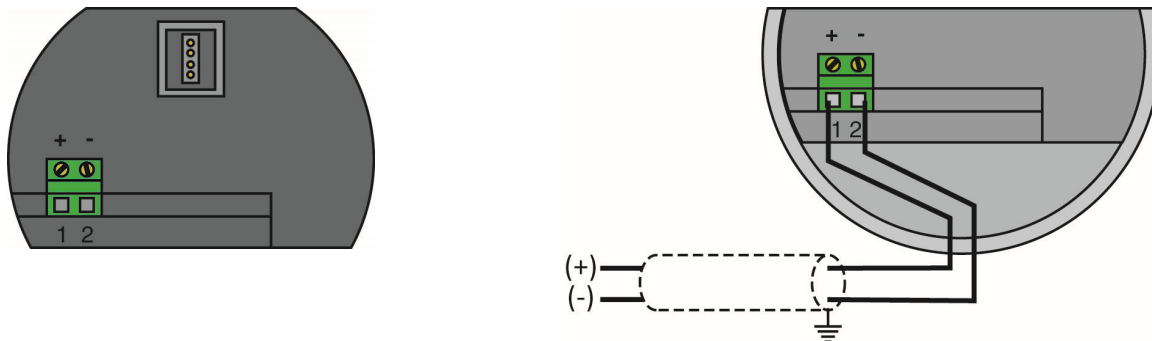

The sensor should be wired with shielded 2-conductor cable (16 to 22 AWG) to protect from electromagnetic interference. If using a liquid tight connector, select a cable with an outer diameter that is designed to ensure an effective seal with the connector [typically between 0.20" to 0.35" (5 to 9 mm)].

ELECTRICAL, USAGE AND SAFETY

1. Wiring should always be done by a licensed electrician in accordance with national, state and local codes.
2. Where personal safety or significant property damage can occur due to a spill, the installation must have a redundant fail-safe backup system installed which accounts for sensor and/or power failure.

HART® WIRING

If a HART® communicator is used, place a 250 Ohm resistor between the sensor negative (-) and the power supply negative (-). Refer to the wiring diagram below as to the placement of the HART® communicator.

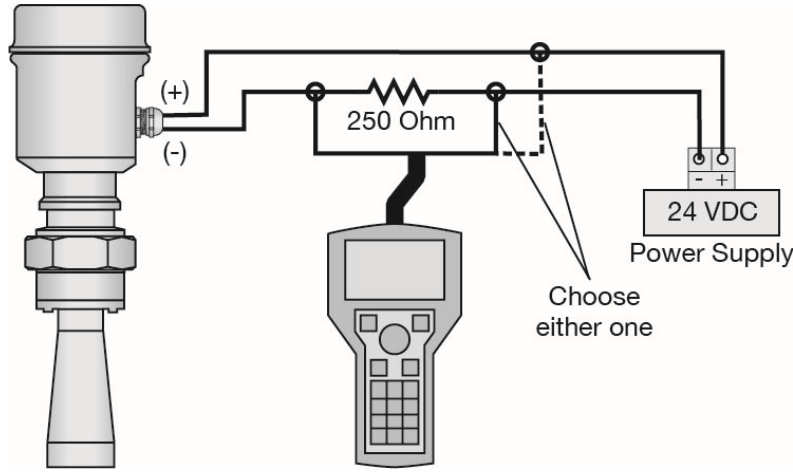

HART® DEVICE DESCRIPTORS (DD FILES)

Note: EchoPro® is HART 7.0 certified and can be configured using a HART communicator. The Device Descriptor (DD) files have been released on the Flowline website and can be installed onto your communicator. The files can be found on the individual EchoPro product pages. Simply click on your sensor from the EchoPro Liquid page (<https://www.flowline.com/echopro-liquid-radar/>).

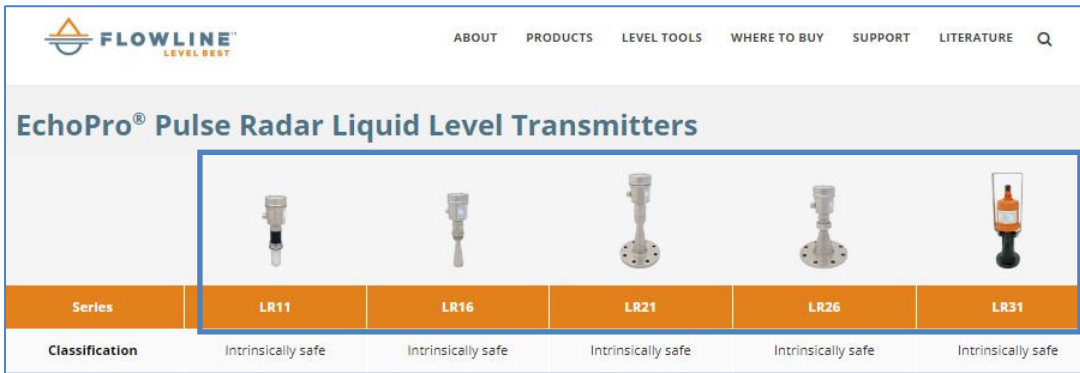

STANDARD VS MULTIDROP

HART® enables multiple HART® devices to share the same two wires. If using multiple HART® devices along the same loop, then each device must have a unique address. Use the Operational Mode (4.6) setting, page 70, to switch from Standard (Address of 00) to Multidrop. Within Multidrop, the address can be changed to a unique number between 1 and 15. Also, the current consumption of the sensor can be switched from the default of 4mA to 8mA. When in Multidrop, the sensor will output a constant current reading.

Operational mode	4.6
Standard	00
Multidrop	
Current	4mA

LR31 CONFIGURATION

There are two main ways to configure the EchoPro® LR31 series:

- 1) Use a HART® communicator.
- 2) Use the included LR98 Display.

⚠ WebCal™ software cannot be used to configure the EchoPro® LR31 series. WebCal™ can be used with the EchoPro® LR11, LR16, LR21 and LR26 series.

If using the HART® communicator, be sure to download and install the DD files into your communicator to make configuration easier.

LR31 WIRING AND DESCRIPTION

The EchoPro LR31 series has a cable extending from the sensor with 8-wires (see below). The sensor can be considered a 2-wire loop powered device. The power for the sensor and the 4-20mA output will be a shared loop using the White (+) and Brown Wire (-). The remaining 6-wires will not be used for normal operation of the LR31 series.

- ⚠ LR98 display is the HMI for the LR31 and is used only to configure the sensor.**
- ⚠ The LR98 is NOT approved for use within intrinsically safe applications and should NOT be used within classified hazardous environments.**

The LR31 series is a loop powered device. Use the White wire as the (+) wire and the Brown wire as the (-) wire. Refer to the following pages for wiring to Displays, Controllers and PLCs.

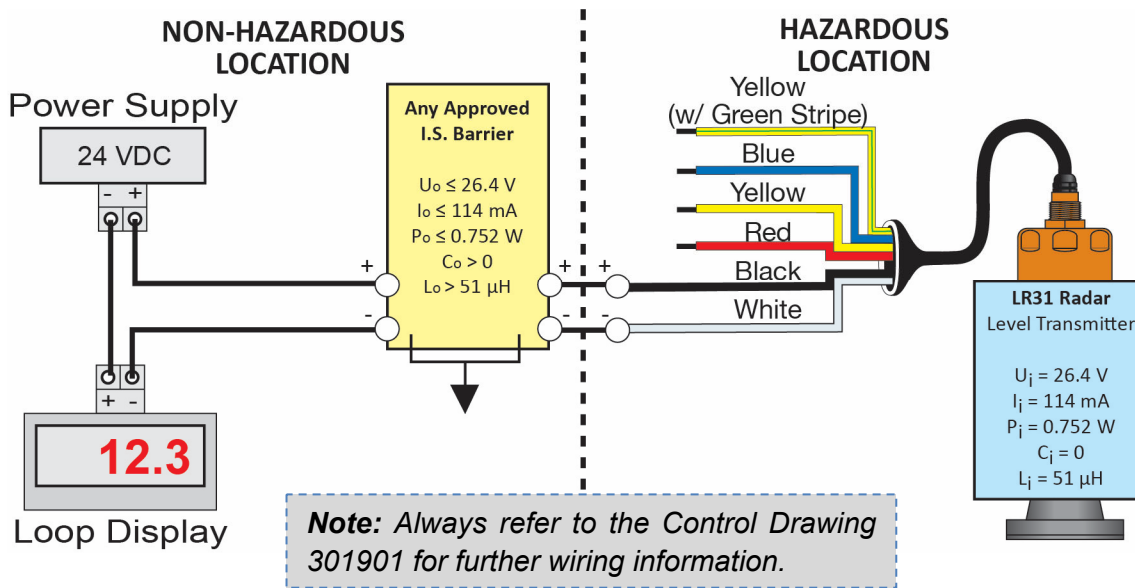

Note: If you have an EchoPulse® LR30 series with 8-conductors, please refer to the Addendum (AD301770) which can be found on the EchoPulse® LR30 product page at flowline.com.

USING LR98 DISPLAY AS HMI FOR LR31 SERIES

The LR98 display is one of two HMI's for the LR31 and is used only to configure the sensor.

⚠ The LR98 is NOT approved for use within intrinsically safe applications and should NOT be used within classified hazardous environments.

Use the LR98 to configure the sensor and remove after the sensor has been configured. Configuration can be performed before installation as long as the dimensions for the installation are known. Accuracy in measurement will result in accuracy of sensor performance.

1. Remove the display (as described previously) to access the input and output terminals within the LR98 display.
2. Referencing the below diagram, connect the appropriately colored 4-conductors (of 6 total) from the LR31 sensor cable to Out [(+) & (-)] & terminals 1-4 on the LR98 display.
3. Finally, connect the 2-conductors (from the user supplied Cable) for loop power input and current output to the (+) and (-) terminals on the LR98 display.
4. Replace the display and apply power to the sensor.

LR98 Display Removal

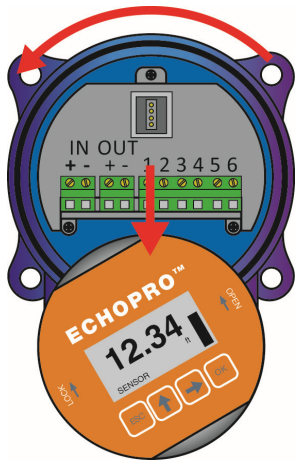

LR98 Display Terminals

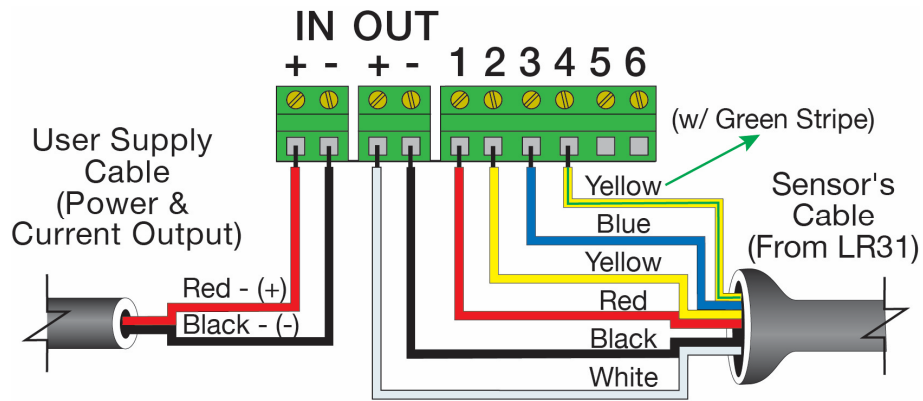

Note: If you have a EchoPulse® LR30 series with 8-conductors, please refer to the Addendum (AD301770) which can be found on the EchoPulse® LR30 product page at flowline.com.

The attached 6-conductor sensor cable will wire directly into the display terminals. A shielded 2-wire cable (user supplied) is required to provide power to and the current output signal from the display. *To confirm the 4-20mA output, place a multimeter (VOM) set to read milliamps in series with the (-) wire (see below).*

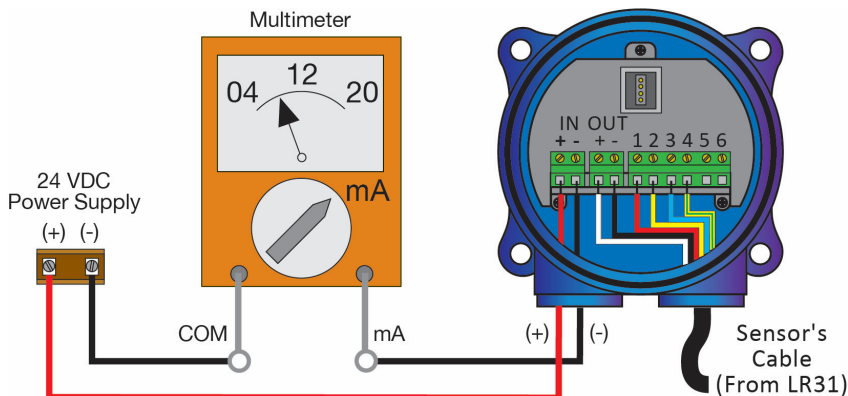

WIRING TO DISPLAYS, CONTROLLERS & PLC'S

Below are examples of how to wire EchoPro® to common displays, controllers and PLC's.

**DataView™ LI55 Series
Level Controller**

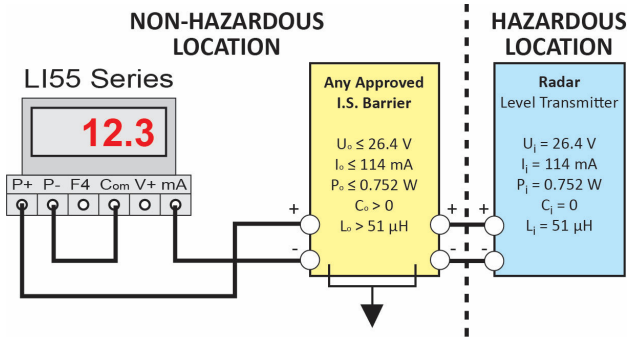

**Commander™ LI90 Series
Multi-Tank Level Controller**

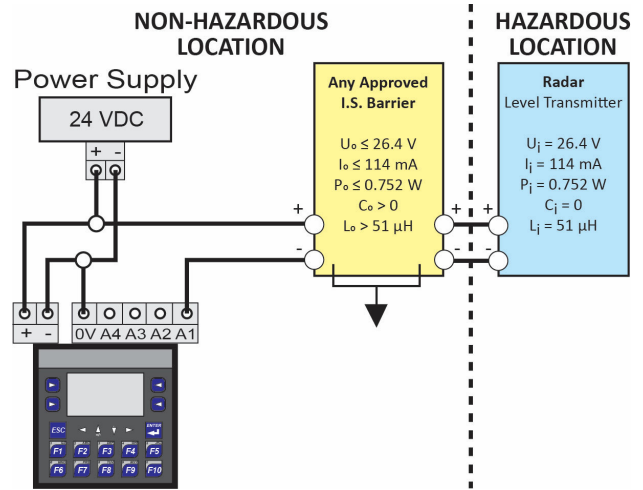

Note: Always refer to the Control Drawing 301901 for further wiring information.

**DataLoop™ LI23 Series
Level Indicator
(Without Backlight)**

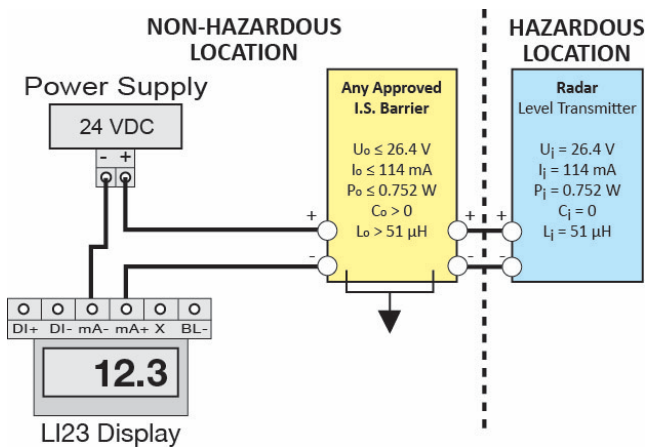

**DataLoop™ LI23 Series
Level Indicator
(With Backlight)**

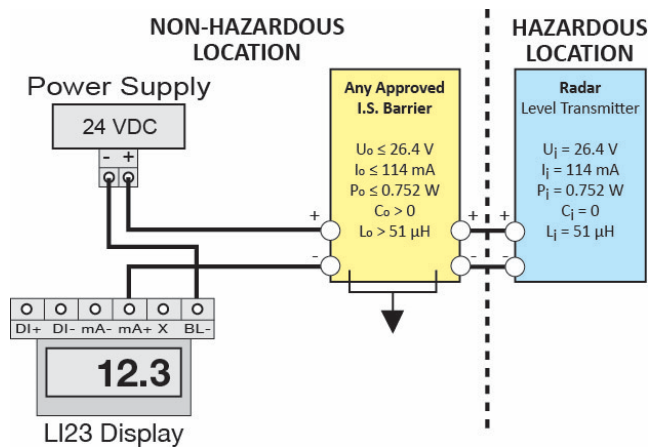

Note: Always refer to the Control Drawing 301901 for further wiring information.

WIRING TO DISPLAYS, CONTROLLERS & PLC'S

**DataPoint™ LC52 Series
Level Controller
(*JWA Mode - Factory Setting)**

Generic PLC

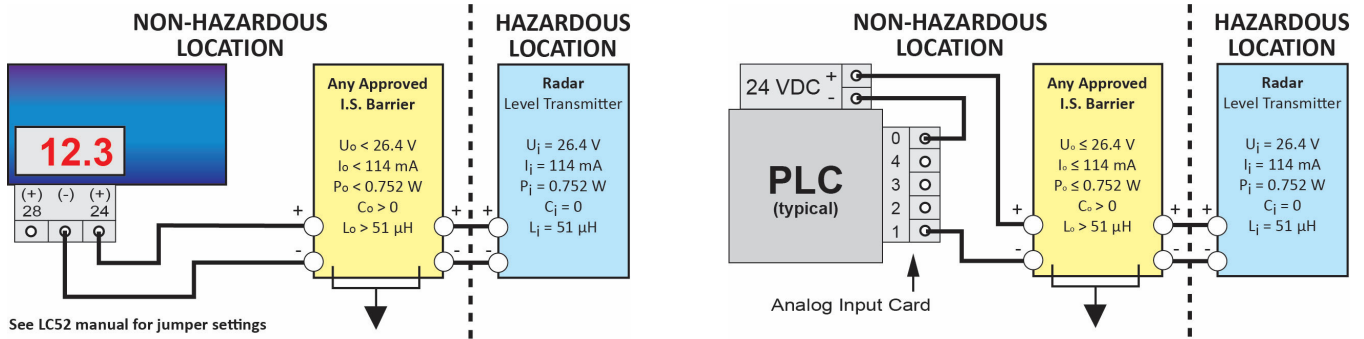

Note: Always refer to the Control Drawing 301901 for further wiring

Generic Loop Powered Display

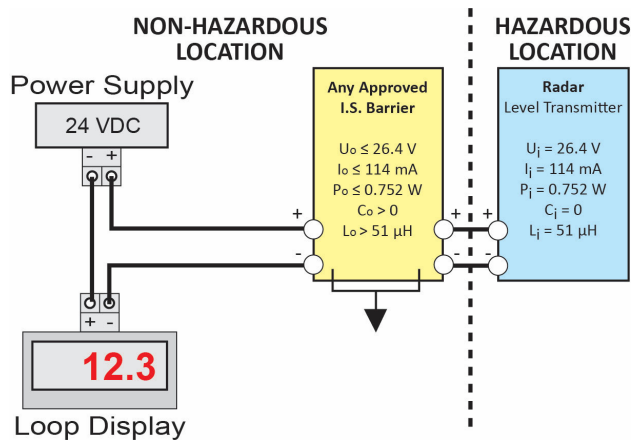

Note: Always refer to the Control Drawing 301901 for further wiring information.

* Refer to the DataPoint™ LC52 Series Level Controller manual for information on JWA mode and JWB mode settings in the controller. Always use the LC52 in JWA mode with the EchoPro®.

BASIC CONFIGURATION OVERVIEW

Below are the 7 basic steps to configure the sensor for operation. Each step is described in detail on the following pages

- 1) Measure the Tank
 - a) Begin by measuring the key tank and fitting dimensions. Correct tank dimensions will result in accurate sensor measurement.
- 2) Set the Units of Measurement
 - a) Units can be configured in basic engineering units of length including Feet or Meters.
- 3) Set the Sensor Height
 - a) This is the empty setting (4mA) for the tank.
- 4) Set the Fill-Height
 - a) This is the full setting (20mA) for the tank.
- 5) Set the Max. Range (Maximum Range or MaxR)
 - a) This is the maximum measurement range for the sensor. The sensor will ignore all echo returns beyond this setting.
- 6) Set the Dead Band (Minimum Range or MinR)
 - a) This is the minimum measurement range for the sensor. The sensor will ignore all echo returns closer than this setting.
- 7) Check the Echo Curve
 - a) This is a quick diagnostic tool to determine if the sensor is reading the correct level.

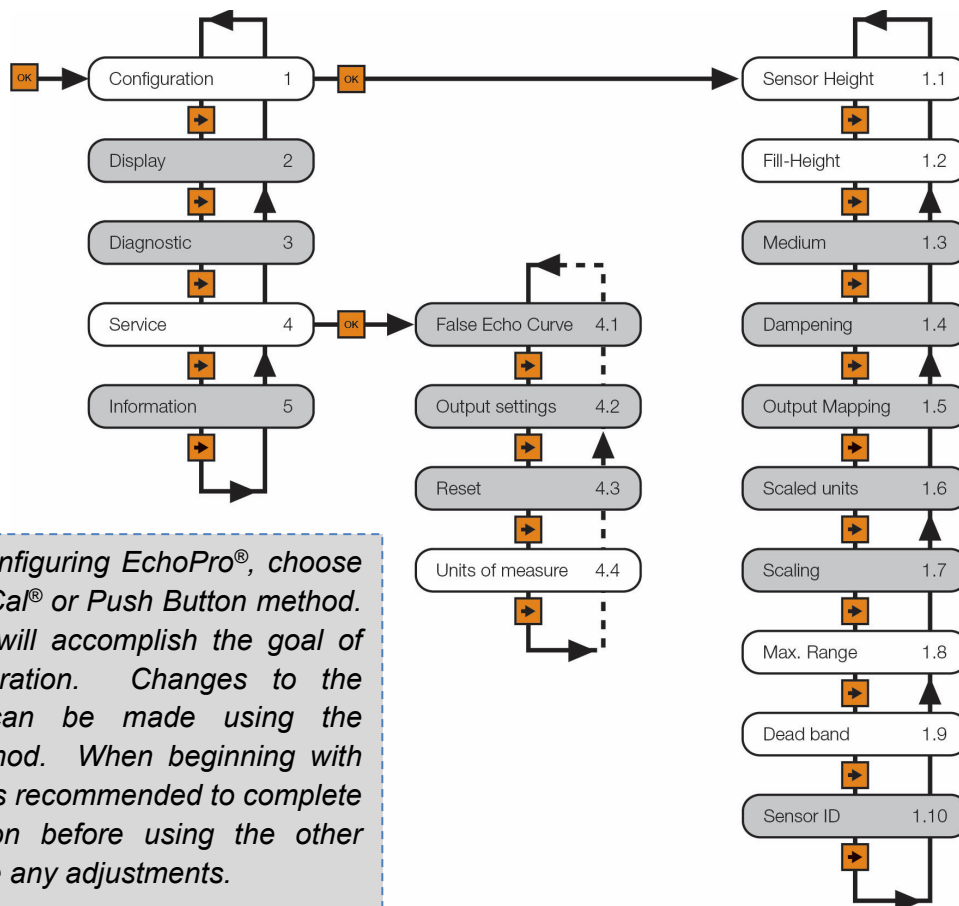

Note: When configuring EchoPro®, choose either the WebCal® or Push Button method. Either method will accomplish the goal of sensor configuration. Changes to the configuration can be made using the alternative method. When beginning with one method, it is recommended to complete the configuration before using the other method to make any adjustments.

USING THE DISPLAY

The display module features a dot matrix LCD display with 4 push buttons on a removable puck. Out of the box, the display indicates level in feet and depicts the level within the 4-20mA span on a bar graph at the right side of the display. The four buttons perform the following functions:

<ul style="list-style-type: none"> • ESCAPE <ul style="list-style-type: none"> ○ Exit configuration mode ○ Return to a higher menu level ○ Display Echo Curve 	<ul style="list-style-type: none"> • Up Arrow <ul style="list-style-type: none"> ○ Modify parameter values ○ Choose display mode
<ul style="list-style-type: none"> • Right Arrow <ul style="list-style-type: none"> ○ Choose configuration options ○ Choose parameter digits to edit ○ Display contents of parameters 	<ul style="list-style-type: none"> • OK <ul style="list-style-type: none"> ○ Enter Menu and Options ○ Confirm configuration options ○ Confirm changes to parameters



MENU INTRODUCTION

- 1) To enter the Main Menu (from the Main Screen), press the **OK** button.
- 2) Use the **Right Arrow** button to scroll through the Main Menu options.
 - a) Configuration - Below are the configuration menu functions:
 - i) Sensor Height
 - ii) Fill-Height
 - iii) Medium
 - iv) Dampening
 - v) Output Mapping
 - vi) Scaled Units
 - vii) Scaling
 - viii) Max. Range
 - ix) Dead Band
 - x) Sensor ID
 - b) Display - This menu function sets the display mode and contrast.
 - c) Diagnostics - Below are the diagnostic menu functions:
 - i) Measurement of Peak Values
 - ii) Measurement Status
 - iii) Echo Curve
 - iv) Simulation
 - d) Service - Within the service menu functions, you can store a False Echo Curve, set units of measurement, change output settings, reset configuration settings, set language or set a PIN for the sensor.
 - e) Info - This item provides information on the sensor's type, serial number, date of manufacture and software version.
- 3) To select one of the functions, press **OK**.
- 4) To exit the programming mode, press **ESC**.

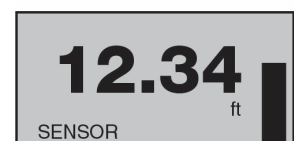
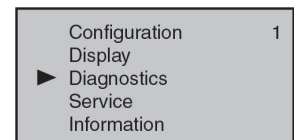
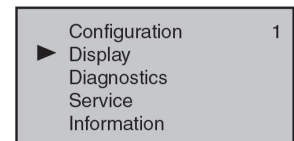
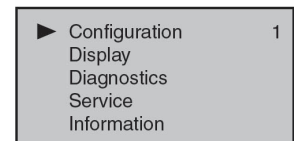
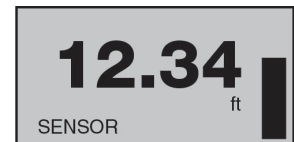

CHANGING DISPLAY VALUES

The numeric values are set using the **Right Arrow** and **Up Arrow** buttons. Press the **Right Arrow** button to select the next digit and the **Up Arrow** button to increment the digit value. The digit being changed is highlighted. Press the **OK** button to accept a setting or the **ESC** button to exit without saving changes. The below exercise illustrates how to change the value of an Empty configuration. Follow the steps to change the setting from 10.00 ft to 12.00 ft. This example applies to all functional settings starting from the Main Menu.

- 1) From the Main Menu, press **OK** to advance into the Configuration menu.
 - a) Sensor Height will appear on the top line of the screen.
- 2) From Sensor Height, press **OK**.
 - a) The “+” sign will be highlighted on the screen.
 - b) This is the adjustment for the percentage setting.
- 3) Press **OK** to move down to the distance setting.
 - a) The first digit, “1”, will be highlighted.
- 4) Press **Right Arrow** to move one digit to the right.
 - a) Use the **Right Arrow** button to move the digit one space to the right.
 - b) Pressing **Right Arrow** on the last digit will jump back to the first digit.
- 5) Press **UP ARROW** to increase the digit from “0” to “1”.
- 6) Press **UP ARROW** to increase the digit from “1” to “2”.
 - a) Use the **UP ARROW** button to increase the digit by one unit.
 - b) After “9”, the display will jump back to “0”.
- 7) Press **OK** to accept the setting as 12.00.
- 8) Press **ESC** to move back to the Main Menu.

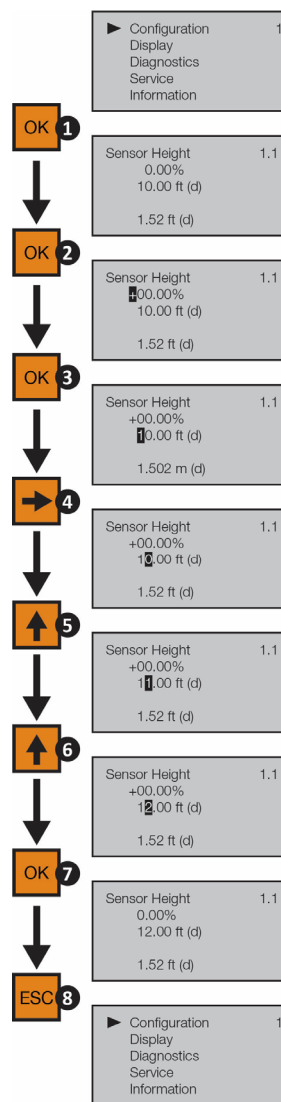

STEP 1 - MEASURE THE TANK

Measuring the tank is one of the most important aspects in configuring the sensor. When measuring the tank, take into account the location of the sensor with respect to fittings, risers, dome tops and bottoms, and identify where the measurements are taken from the sensor.

Note: The location for measurement may be different among different sensor Series, based upon the type of antenna. Refer to the Measurement Reference Chart for the measurement location of your sensor. The basic measurements for configuration are described below:

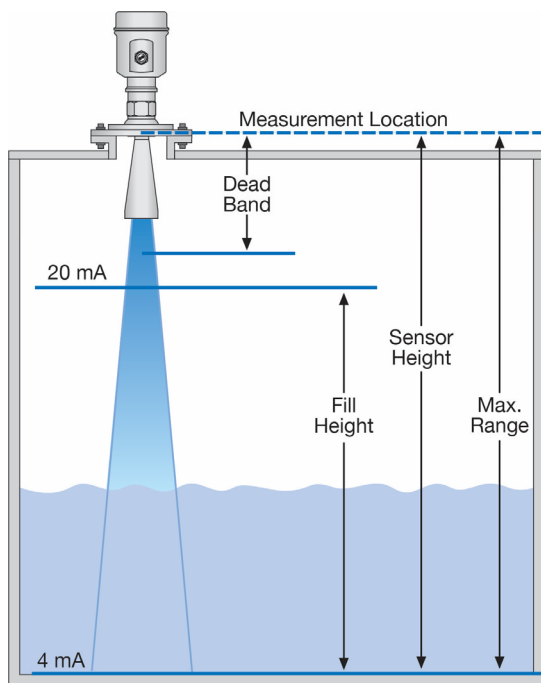

- 1) Distance from the sensor's measurement location to the bottom of the tank is the **Max. Range** value. The Range value is typically set at the bottom of the tank.
- 2) Distance from the sensor's measurement location to the empty or lowest liquid level in the tank is the **Sensor Height**.
 - a) Empty Configuration = 4mA setting.
 - b) With flat bottom tanks, the Max. Range and Sensor Height values can be the same.
- 3) Distance from the above 0% location to the full or highest liquid level in the tank is the **Fill-Height**.
 - a) Fill-Height = 20mA setting.

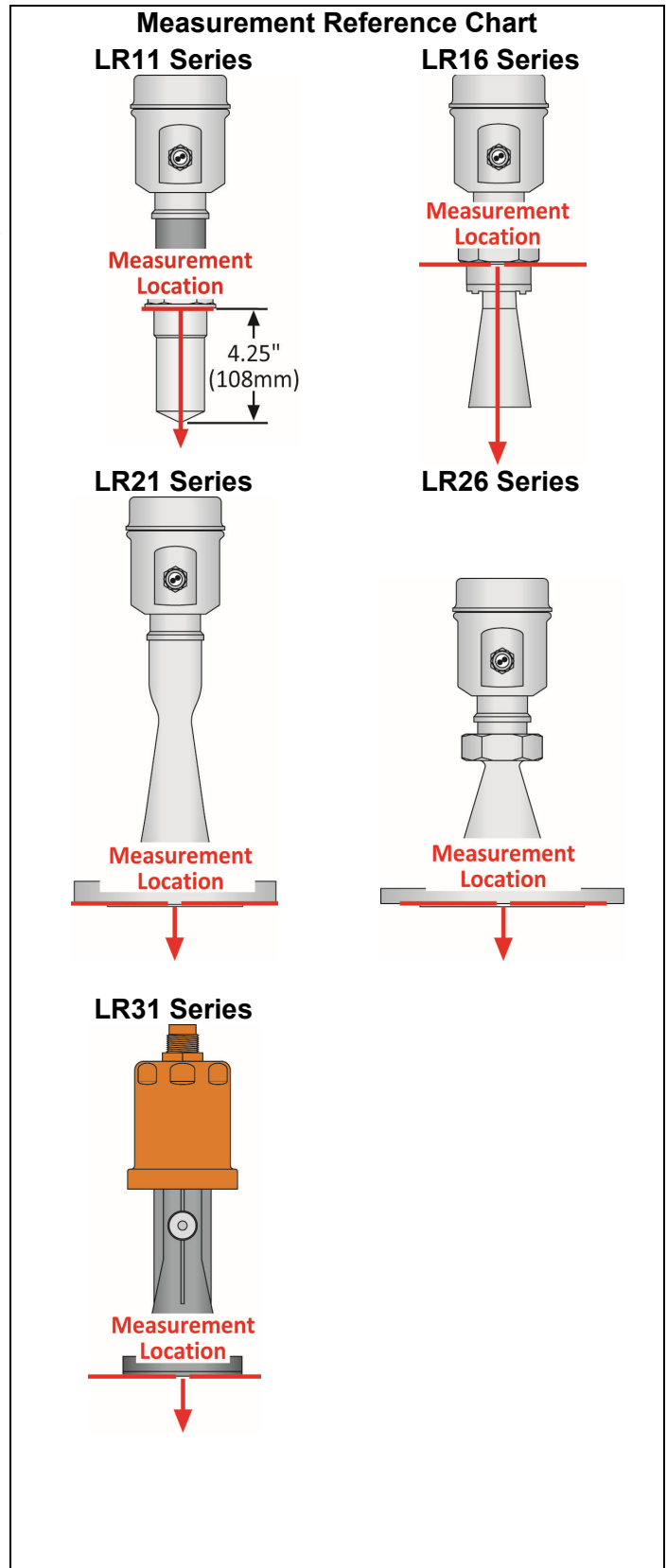

STEP 2 - SET THE UNITS OF MEASUREMENT

This function sets the units for all measurement values to be entered into the sensor.

- 1) From the Main Screen, press **OK** to advance into the Main Menu.
- 2) Press **Right Arrow** repeatedly until the arrow is next to Service.
- 3) Press **OK** to advance into the Service menu (and Echo curve will appear).
- 4) Press **Right Arrow** repeatedly until the menu shows Units of Measurement.
- 5) Press **OK** to advance into Units of Measurement.
- 6) Press **Right Arrow** to change the setting between feet [ft (d)] and meters [m (d)].
- 7) When the units are correct, press **OK** to save the setting.
- 8) When done, press **ESC** to return to the Main Menu, and press **ESC** a second time to return to the Main Screen.

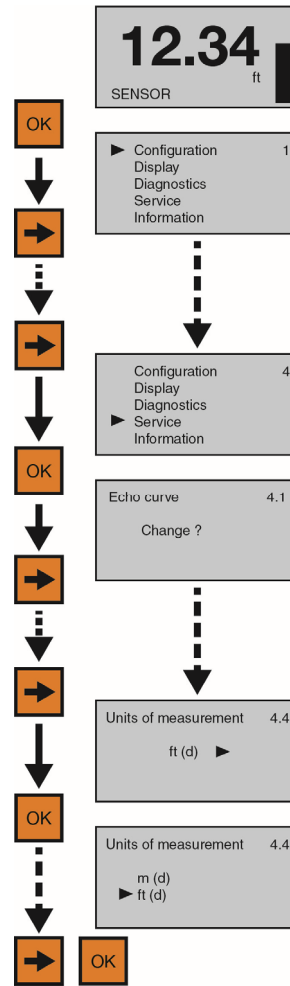

STEP 3 - SET THE SENSOR HEIGHT (4MA)

This function sets the Sensor Height point corresponding to an empty position in the tank. The measured distance of Sensor Height from the sensor will set the 4mA location as well as establish the 0% span of the sensor.

- 1) From the Main Screen, press **OK** to advance into the Main Menu.
- 2) Press **OK** to advance into the Configuration Menu.
- 3) Press **OK** to advance into Sensor Height. The first percentage segment will be highlighted.
- 4) Press **OK** again to switch to the distance (d) setting.
- 5) Press **Right Arrow** to move one segment to the right. **Right Arrow** will scroll left to right and then back to the first segment.
- 6) Press **Up Arrow** to increase the value of the number highlighted. **Up Arrow** will scroll from 0 to 9 and back again.
- 7) When the value is correct, press **OK** to save the setting.
- 8) When done, press **ESC** to return to the Main Menu, and press **ESC** a second time to return to the Main Screen or; if you want to advance directly into Fill-Height, press **Right Arrow**.

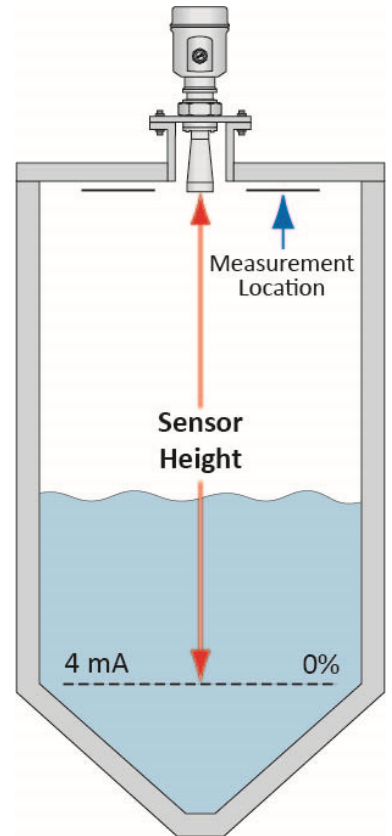
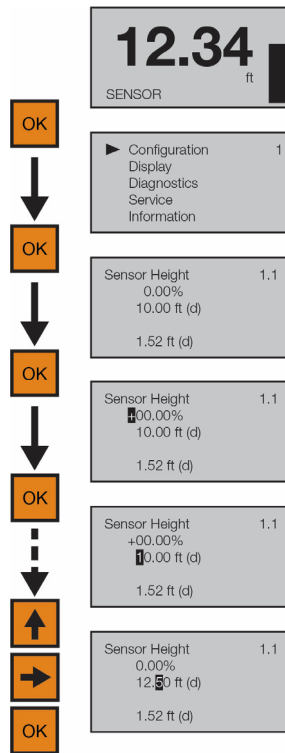

STEP 4 - SET THE FILL-HEIGHT (20MA)

This function sets the Fill-Height point corresponding to a full position in the tank. The measured distance of Fill-Height from the 0% or empty position will set the 20mA location as well as establish the 100% span of the sensor.

- 1) From the Main Screen, press **OK** to advance into the Main Menu.
- 2) Press **OK** to advance into the Configuration Menu.
- 3) Press **Right Arrow** to advance into Full Configuration.
- 4) Press **OK** to advance into Full Configuration. The first percentage segment will be highlighted.
- 5) Press **OK** again to switch to the distance (d) setting.
- 6) Press **Right Arrow** to move one segment to the right. **Right Arrow** will scroll left to right and then back to the first segment.
- 7) Press **Up Arrow** to increase the value of the number highlighted. **Up Arrow** will scroll from 0 to 9 and back again.
- 8) When the value is correct, press **OK** to save the setting.
- 9) When done, press **ESC** to return to the Main Menu, and press **ESC** a second time to return to the Main Screen or; If you want to advance directly into Range, press **Right Arrow** repeatedly until Max. Range appears.

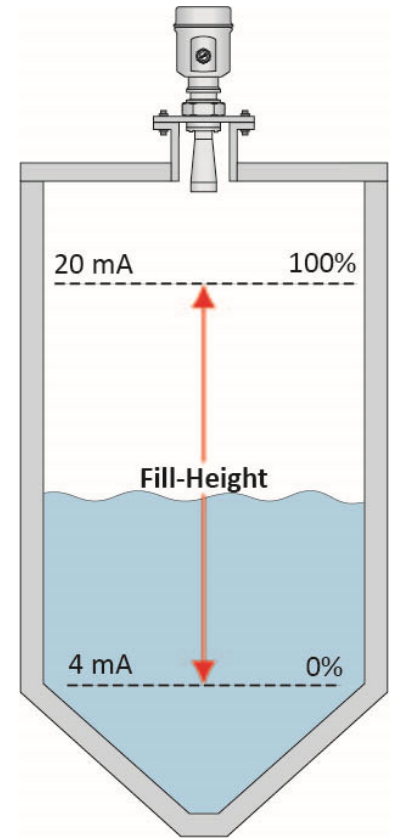
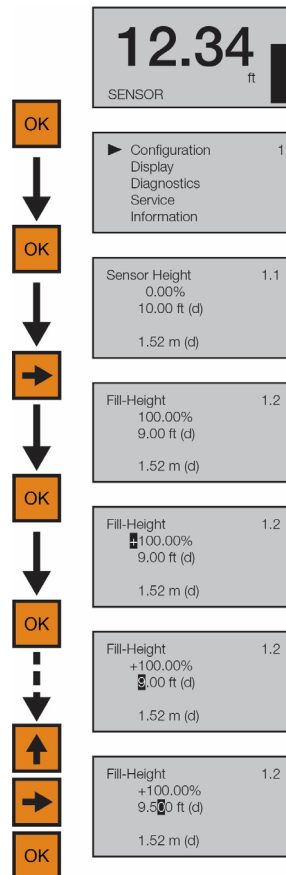

STEP 5 - SET THE MAX. RANGE (MAXIMUM RANGE)

This function sets the maximum operational range for the sensor. This setting defines the maximum distance that the sensor will detect valid echo returns.

- 1) From the Main Screen, press **OK** to advance into the Main Menu.
- 2) Press **OK** to advance into the Configuration Menu.
- 3) Press **Right Arrow** repeatedly until the menu shows Max. Range.

- 4) Press **OK** to edit Max. Range value. The first segment will be highlighted.

- 5) Press **Right Arrow** to move one segment to the right. **Right Arrow** will scroll left to right and then back to the first segment.

- 6) Press **Up Arrow** to increase the value of the number highlighted. **Up Arrow** will scroll from 0 to 9 and back again.

- 7) When the value is correct, press **OK** to save the setting.

- 8) When done, press **ESC** to return to the Main Menu, and press **ESC** a second time to return to the Main Screen or; if you want to advance directly into Dead Band, press **Right Arrow** repeatedly until Dead Band appears.

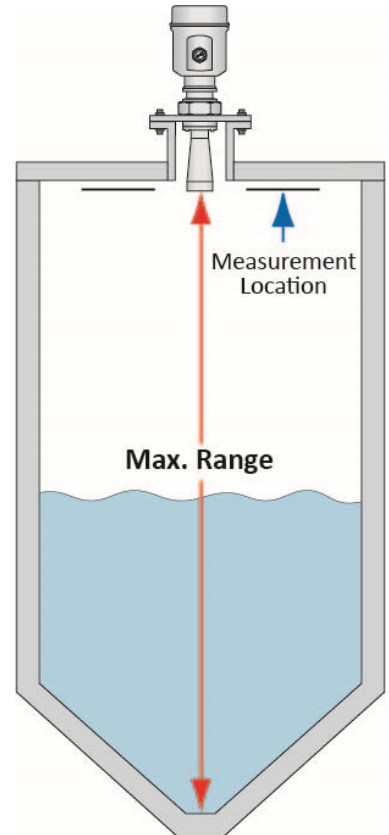
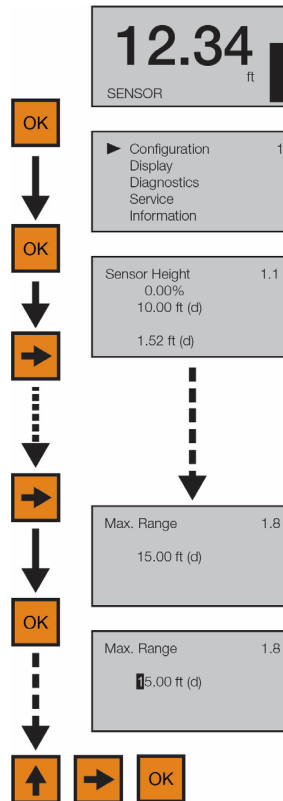

STEP 6 - SET THE DEAD BAND

This function sets the Dead Band for the sensor. This setting defines the minimum distance that the sensor will detect valid echo returns. While the Dead Band setting is typically configured to be equal with or slightly above (higher in the tank) the Full Configuration setting (20 mA), its functions independently of Full Configuration. **Note:** If the Dead Band setting is placed below the Full Configuration setting, then the sensor will not measure above the Dead Band.

Dead Band Equals Full Config.

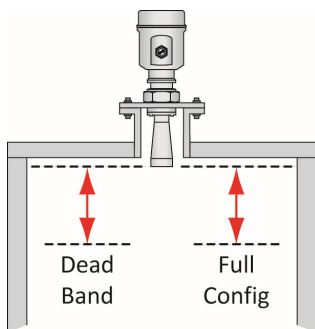

Dead Band Below Full Config.

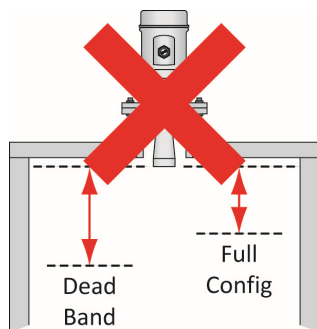

Dead Band Above Full Config.

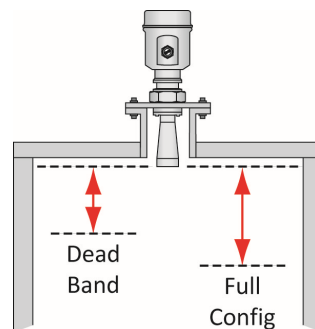

- 1) From the Main Screen, press **OK** to advance into the Main Menu.
- 2) Press **OK** to advance into the Configuration Menu.
- 3) Press **Right Arrow** repeatedly until menu shows Dead Band.
- 4) Press **OK** to edit Dead Band value. The first segment will be highlighted.
- 5) Press **Right Arrow** to move one segment to the right. **Right Arrow** will scroll left to right and then back to the first segment.
- 6) Press **Up Arrow** to increase the value of the number highlighted. **Up Arrow** will scroll from 0 to 9 and back again.
- 7) When the value is correct, press **OK** to save the setting.
- 8) When done, press **ESC** to return to the Main Menu, and press **ESC** a second time to return to the Main Screen.

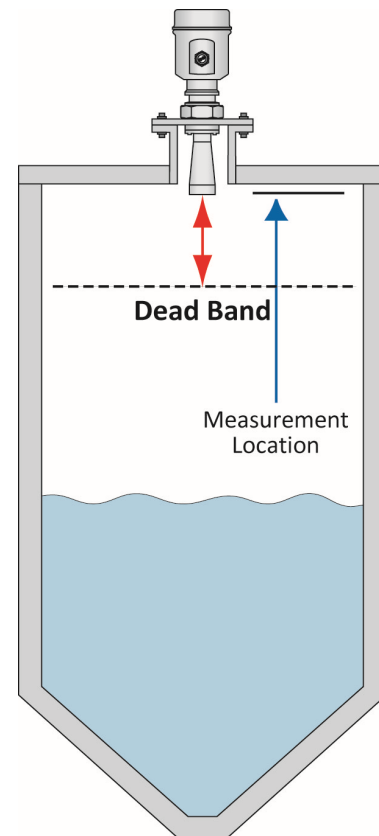
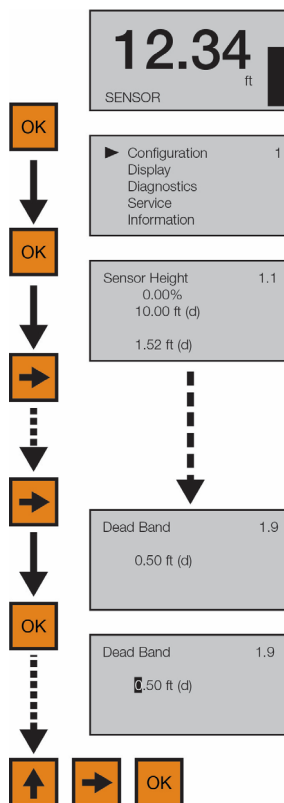

STEP 7 - CHECK THE ECHO CURVE

This function displays the primary echo return(s) that the sensor is seeing graphically, the location and amplitude of the return(s), and the numeric air gap distance from the sensor’s measurement location to the liquid level below.

Note: *This step should only be performed after having completed the prior six configuration steps with the sensor installed on the tank.* Additionally, if the sensor was installed in a stand pipe or sight glass, now go forward to Section Seven and turn on the still well function (Sensor Installed in a Stand Pipe or Sight Glass) before continuing with this step.

- 1) From the Main Screen, press **ESC** and the Echo Curve Screen will appear. The curve graphically represents the primary echo return(s) amplitude (Y-axis) over distance (X-axis). Above the echo return peak is a floating arrow and triangle symbol (which under normal conditions are often merged together or seen as a single triangle because it’s the larger of the two symbols). The arrow represents the measured liquid level and the triangle represents the peak amplitude location of the echo return. Under normal conditions, expect to see a stable triangle (or overlapping arrow and triangle) floating above a pronounced peak at the expected air gap distance between the measurement location and liquid level.
- 2) In the upper right hand corner of the screen are two lines of numbers that represent the air gap distance from the measurement location to the liquid level (arrow) on the top, and peak amplitude location (triangle) of the echo return on the bottom. Under normal conditions, these values should be relatively close to one another and consistent with the expected air gap distance between the measurement location and liquid level.
- 3) Assuming that the sensor is properly installed, if the measured liquid level and peak amplitude location data (symbols and values) are unstable, substantially different from one another and/or inconsistent with the actual air gap distance, then this likely indicates that the sensor requires additional process adjustment(s) described in the following Section Six.
- 4) When done, press **ESC** to return to the Main Menu.

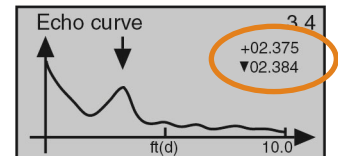
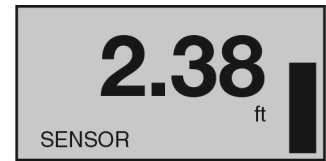

**Page
Left
Intentionally
Blank**

PROCESS ADJUSTMENTS OVERVIEW (LIQUIDS ONLY)

These optional functions are intended to improve sensor performance in applications with the below process and/or installation characteristics. **Note:** *These adjustments should only be performed when (after having completed the seven configuration steps described in Section Five with the sensor installed on the tank) the sensor is not performing to your satisfaction.* Where so, perform the following applicable Process Adjustments.

- 1) Fast Level Change - Fast Filling or Emptying of the Liquid
- 2) First Echo - Liquid Requiring First Echo Adjustment
- 3) Turbulent Surface - Liquid Surface is Turbulent or Agitated Surface
- 4) Foam - Foam on the Surface of the Liquid
- 5) Low Dielectric - Liquids with Low Dielectric
- 6) Still Well - Sensor Installed in a Stand Pipe or Sight Glass

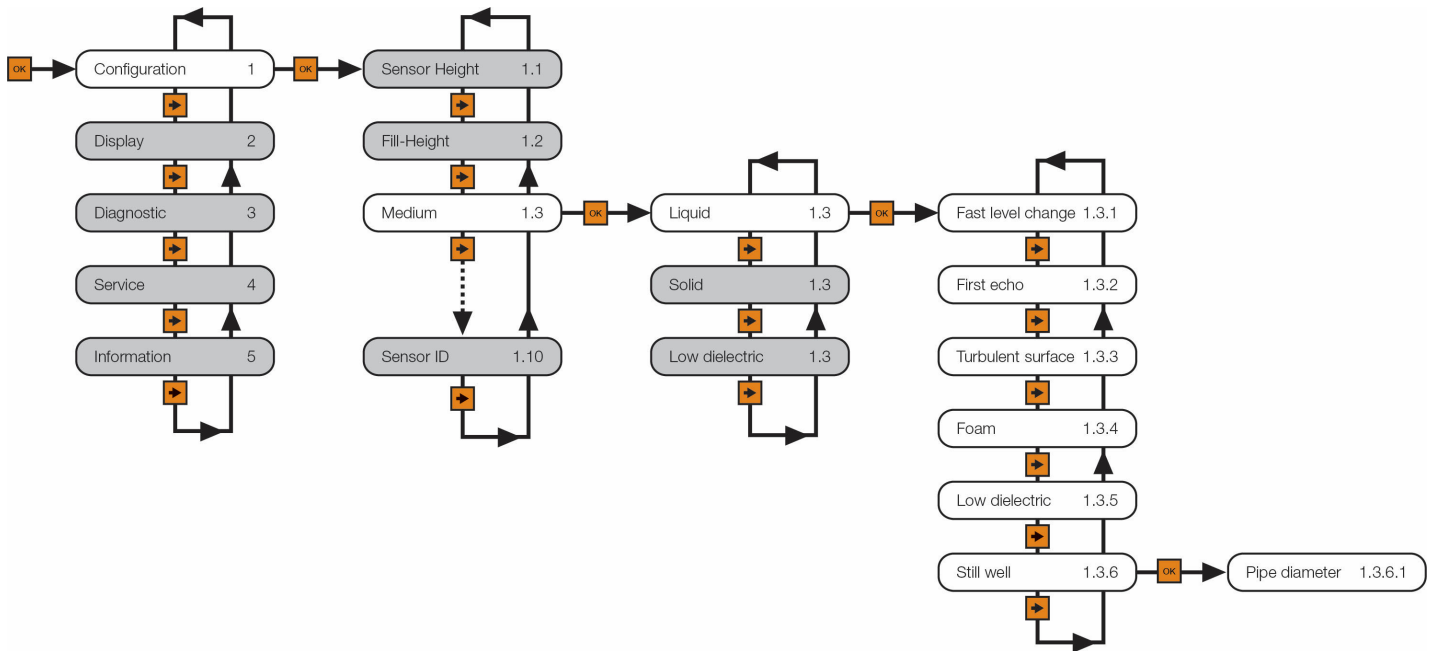

FAST FILLING OR EMPTYING OF LIQUID (FAST LEVEL CHANGE)

If the speed of media level rise or fall within the tank is greater than a rate of 1” per second (25.4mm/sec), set Fast Level Change to Yes. **Note:** Fast filling or emptying can occur when multiple pumps are operating or when a weather event increases the amount of media entering the tank.

- 1) From the Main Screen, press **OK** to advance into the Main Menu.
- 2) Press **OK** to advance into the Configuration Menu.
- 3) Press **Right Arrow** to advance from Sensor Height to Fill-Height.
- 4) Press **Right Arrow** to advance from Fill-Height to Medium.
- 5) Press **OK** to advance into Medium. Liquid, Solid, Low Dielectric will appear.
- 6) Press **OK** to advance into Liquid. Fast Level Change will appear first.
- 7) Press **OK** to advance into Fast Level Change.
- 8) Press **Right Arrow** to change the Fast Level Change setting.
- 9) When the setting is correct, press **OK** to save.
- 10) When done, press **ESC** to return to Medium, press **ESC** again to return to the Configuration Menu, and press **ESC** a third time to return to the Main Screen or; If you want to advance directly into Turbulent Surface, press **Right Arrow** repeatedly until Turbulent Surface appears.

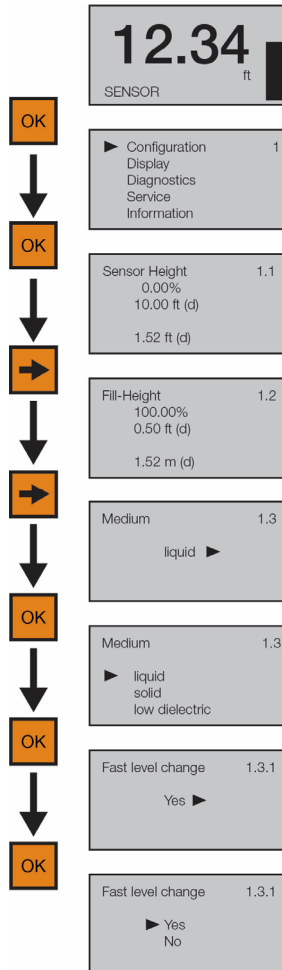

Normal Level Change

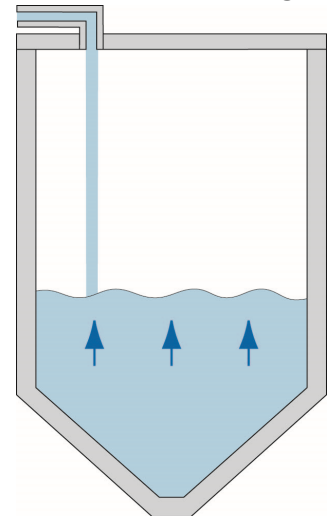

Fast Level Change

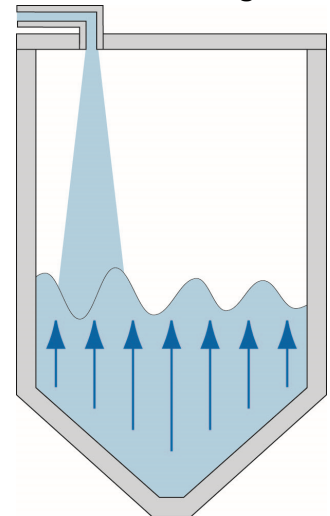

LIQUIDS REQUIRING FIRST ECHO ADJUSTMENT (FIRST ECHO)

This function increases or decreases the peak strength of the sensor’s First Echo return, and should only be performed if: 1) The liquid has a very high dielectric constant value and primarily stays in the near full range of the tank, resulting in a very high First Echo peak strength or; 2) Process conditions, such as when the media has a very low dielectric constant value, or when obstructions, heavy foam or turbulence exist in the tank, resulting in little or no First Echo peak strength. **Note:** Under condition one (Example 1), it can be beneficial to decrease the First Echo peak strength. Under condition two (Example 3), it can be beneficial to increase the First Echo peak strength.

Example 1

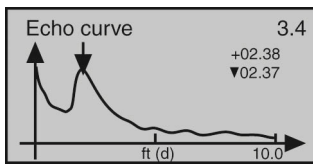

First Echo peak is very strong and can be reduced.

Example 2

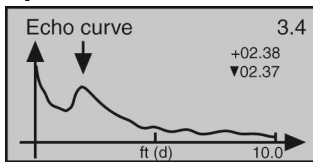

First Echo peak is normal and no adjustment is required.

Example 3

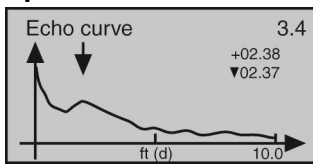

First Echo peak is weak and can be increased.

First Echo Adjustments

- Normal - No adjustment
- Small - Decrease by 10 dB
- Big - Increase by 10 db
- Bigger - Increase by 20 db
- Biggest - Increase by 40 db

- 1) From the Main Screen, press **OK** to advance into the Main Menu.
- 2) Press **OK** to advance into the Configuration Menu.
- 3) Press **Right Arrow** to move from Empty Configuration to Full Configuration.
- 4) Press **Right Arrow** to move from Full Configuration to Medium.
- 5) Press **OK** to advance into Medium and Liquid, Solid & Low Dielectric will appear.
- 6) Press **OK** to advance into Solids and Fast Level Change will appear.
- 7) Press **Right Arrow** to move from Fast Level Change to First Echo.
- 8) Press **OK** to advance into First Echo.
- 9) Press **Right Arrow** to change the First Echo setting.
- 10) When setting is correct, press **OK** to save.
- 11) When done, press **ESC** to return to Medium, press **ESC** again to return to the Configuration Menu, and press **ESC** a third time to return to the Main Screen or; If you want to advance directly into Large Repose Angle, press **Right Arrow** repeatedly until Large Repose Angle.

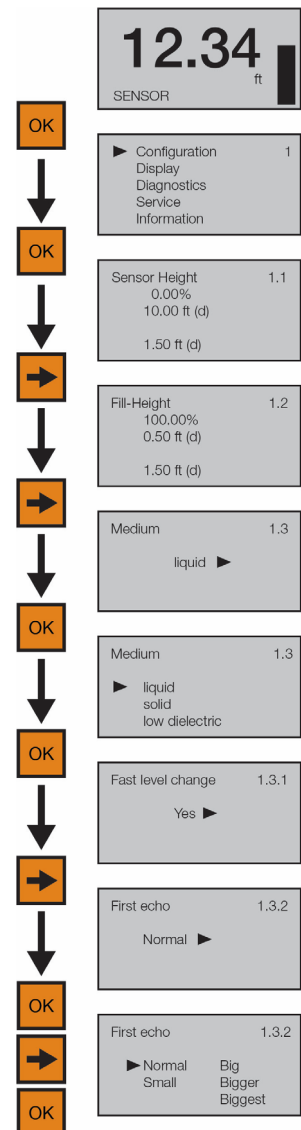

LIQUID SURFACE IS TURBULENT OR AGITATED (TURBULENT SURFACE)

If the liquid surface is turbulent or agitated, set Turbulent Surface to Yes. **Note:** Turbulent or agitated surfaces can occur when tanks are filled from the top without a down pipe, or when a mixer or air agitation is used within the tank.

- 1) From the Main Screen, press **OK** to advance into the Main Menu.
- 2) Press **OK** to advance into the Configuration Menu.
- 3) Press **Right Arrow** to advance from Sensor Height to Fill-Height.
- 4) Press **Right Arrow** to advance from Fill-Height to Medium.
- 5) Press **OK** to advance into Medium. Liquid, Solid, Low Dielectric will appear.
- 6) Press **OK** to advance into Liquid. Fast Level Change will appear first.
- 7) Press **Right Arrow** to advance from Fast Level Change to First Echo.
- 8) Press **Right Arrow** to advance from First Echo to Turbulent Surface.
- 9) Press **OK** to advance into Turbulent Surface.
- 10) Press **Right Arrow** to change the Turbulent Surface setting.
- 11) When the setting is correct, press **OK** to save.
- 12) When done, press **ESC** to return to Medium, press **ESC** again to return to the Configuration Menu, and press **ESC** a third time to return to the Main Screen or; If you want to advance directly into Foam, press **Right Arrow** repeatedly until Foam appears.

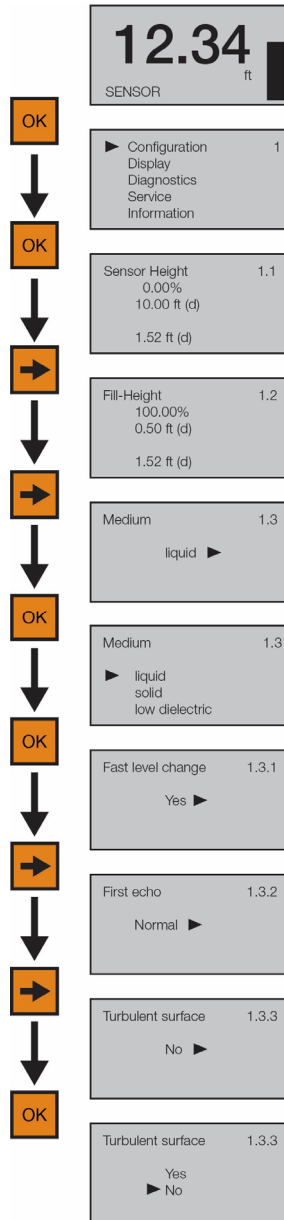

Turbulence from Tank Fill

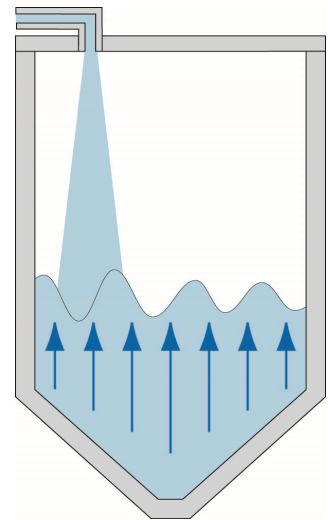

Agitation from Mixer

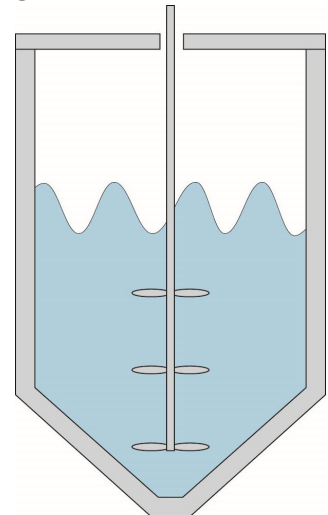

FOAM ON THE SURFACE OF THE LIQUID (FOAM)

If the entire liquid surface is covered with foam, set Foam to Yes. This is not necessary if the liquid surface is partially covered with foam. **Note:** Foam can occur when tanks are filled from the top without a down-fill pipe, or when a mixer or air agitation is used within the tank.

- 1) From the Main Screen, press **OK** to advance into the Main Menu.
- 2) Press **OK** to advance into the Configuration Menu.
- 3) Press **Right Arrow** to advance from Sensor Height to Fill-Height.
- 4) Press **Right Arrow** to advance from Fill-Height to Medium.
- 5) Press **OK** to advance into Medium. Liquid, Solid, Low Dielectric will appear.
- 6) Press **OK** to advance into Liquid. Fast Level Change will appear first.
- 7) Press **Right Arrow** repeatedly until Foam 1.3.4 appears.
- 8) Press **OK** to advance into Foam.
- 9) Press **Right Arrow** to change the Foam setting.
- 10) When the setting is correct, press **OK** to save.
- 11) When done, press **ESC** to return to Medium, press **ESC** again to return to the Configuration Menu, and press **ESC** a third time to return to the Main Screen or; If you want to advance directly into Still Well, press **Right Arrow** repeatedly until Still Well appears.

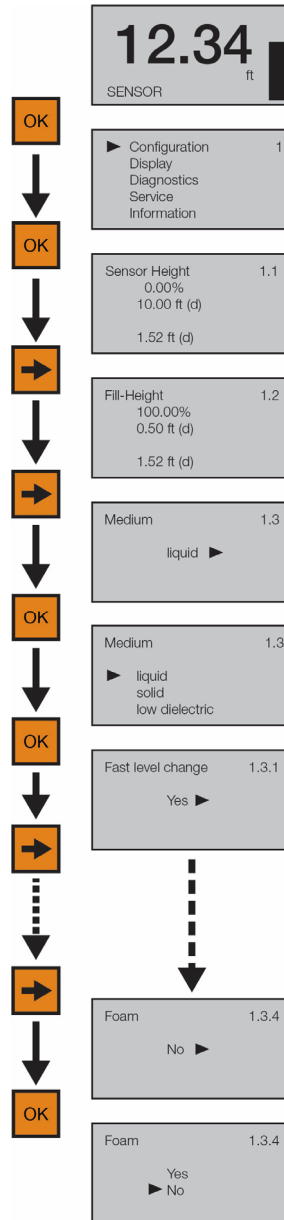

Heavy Foam – If foam covers the entire surface of the liquid, set Foam to Yes.

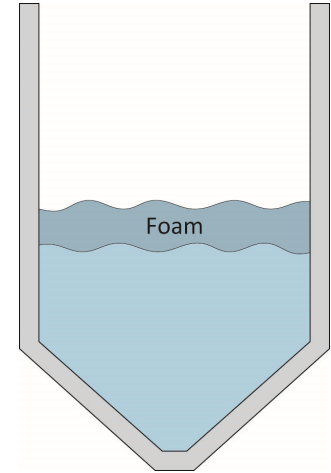

Light Foam – If foam partially covers the surface of the liquid, set Foam to No.

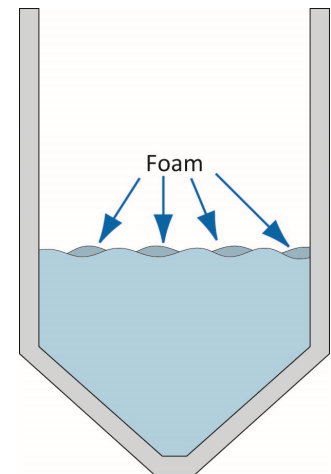

LIQUIDS WITH LOW DIELECTRIC (LOW DIELECTRIC)

Used when the liquid has a low dielectric constant (typically under 10). Selections are YES or NO. **Default is NO.**

- 1) From the Main Screen, press **OK** to advance into the Main Menu.
- 2) Press **OK** to advance into the Configuration Menu.
- 3) Press **Right Arrow** repeatedly until menu shows Medium.
- 4) Press **OK** to advance into Medium. Liquid, Solid & Low Dielectric will appear.
- 5) Press **OK** to advance into Solids. Fast Level Change will appear first.
- 6) Press **Right Arrow** repeatedly until Low Dielectric appears.
- 7) Press **OK** to advance into Low Dielectric.
- 8) Press **Right Arrow** to change the setting from No to Yes.
- 9) Press **OK** to enter the Pipe Diameter.
- 10) When the value is correct, press **OK** to save.
- 11) When done, press **ESC** to return to Medium, press **ESC** again to return to the Configuration Menu, and press **ESC** a third time to return to the Main Screen.

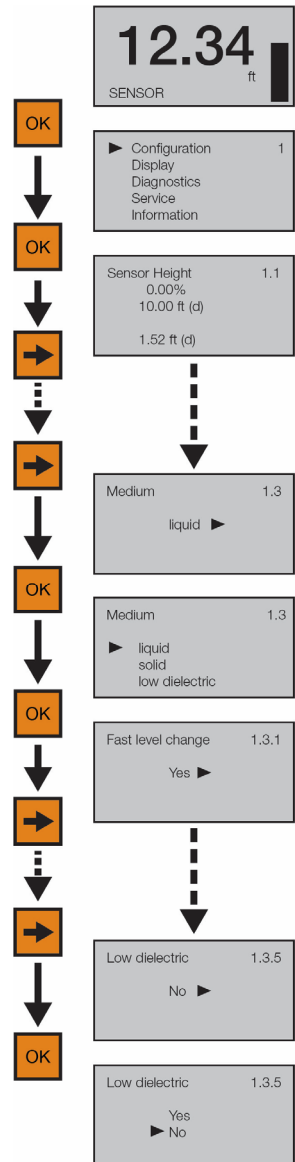

SENSOR INSTALLED IN A STAND PIPE OR BYPASS CHAMBER - LIQUIDS ONLY (STILL WELL)

If the sensor is installed in a metal stand pipe (still well) or metal bypass chamber, set Still Well to yes and enter the inner Pipe Diameter dimension. **Note:** The Pipe Diameter will be entered in millimeters. For example, a 3” pipe can have an inner diameter of 3.042”. To convert inches to mm, multiply inches by 25.4mm. Thus, a 3.042” pipe inner diameter equals 77.26mm. You would then enter the value of 77mm.

- 1) From the Main Screen, press **OK** to advance into the Main Menu.
- 2) Press **OK** to advance into the Configuration Menu.
- 3) Press **Right Arrow** repeatedly until menu shows Medium.
- 4) Press **OK** to advance into Medium. Liquid, Solid & Low Dielectric will appear.
- 5) Press **OK** to advance into Liquid. Fast Level Change will appear first.
- 6) Press **Right Arrow** repeatedly until Still Well appears.
- 7) Press **OK** to advance into Still Well.
- 8) Press **Right Arrow** to change the setting from No to Yes.
- 9) Press **OK** to enter the Pipe Diameter.
- 10) Use the **Right Arrow** to move one segment to the right. **Right Arrow** will scroll left to right and then back to the first segment.
- 11) Use the **Up Arrow** to increase the value of the number highlighted. **Up Arrow** will scroll from 0 to 9 and back again. When the value is correct, press **OK** to save.
- 12) When done, press **ESC** to return to Medium, press **ESC** again to return to the Configuration Menu, and press **ESC** a third time to return to the Main Screen.

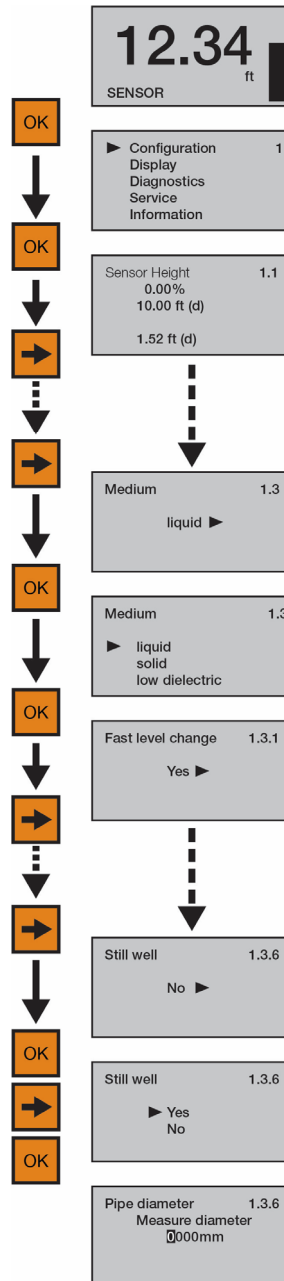

Still Well or Stand Pipe

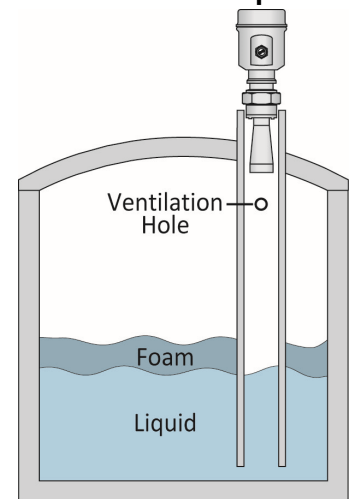

Bypass Chamber

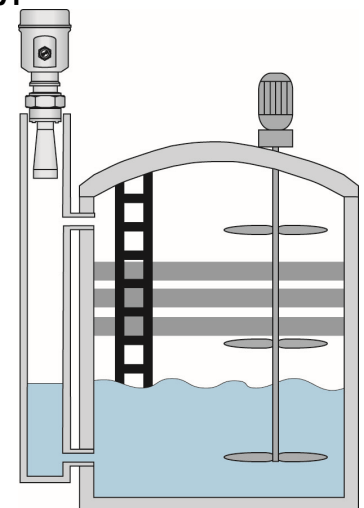

ADVANCED ADJUSTMENTS OVERVIEW

These optional functions are used to change the sensor output characteristics, or Create a False Echo Curve to filter out false echo returns within the tank (improving sensor performance), or Update an existing False Echo Curve filter if the original filter was not created during an empty tank condition.

- 1) **4-20 mA Rev Output** - Reverses the current output from 4mA @ bottom and 20mA @ top of tank to 20mA @ bottom and 4mA @ top of the tank.
- 2) **Fail-Safe** - Allows for the presetting of the current output when a sensor failure occurs. Options are no change to current, 20.5mA or 22mA.
- 3) **Minimum Current** - Sets the minimum current output for the sensor. Options are 4.0mA or 3.9mA.
- 4) **HART® Operational Mode** – Sets the device address as well as sets the current draw for the device.
- 5) **Create a new False Echo Curve** - A method to filter out false echo returns within the tank. This should be performed when the tank is at its lowest level (empty).
- 6) **Update an existing False Echo Curve** - A method to update an existing False Echo Curve to include a lower section of the tank that was not exposed during the creation of the original Echo Curve.
Note: If you don't know the location (level position) or validity of the original False Echo Curve, it is recommended to delete the original Echo Curve, and then create a new False Echo Curve (versus updating an existing False Echo Curve).

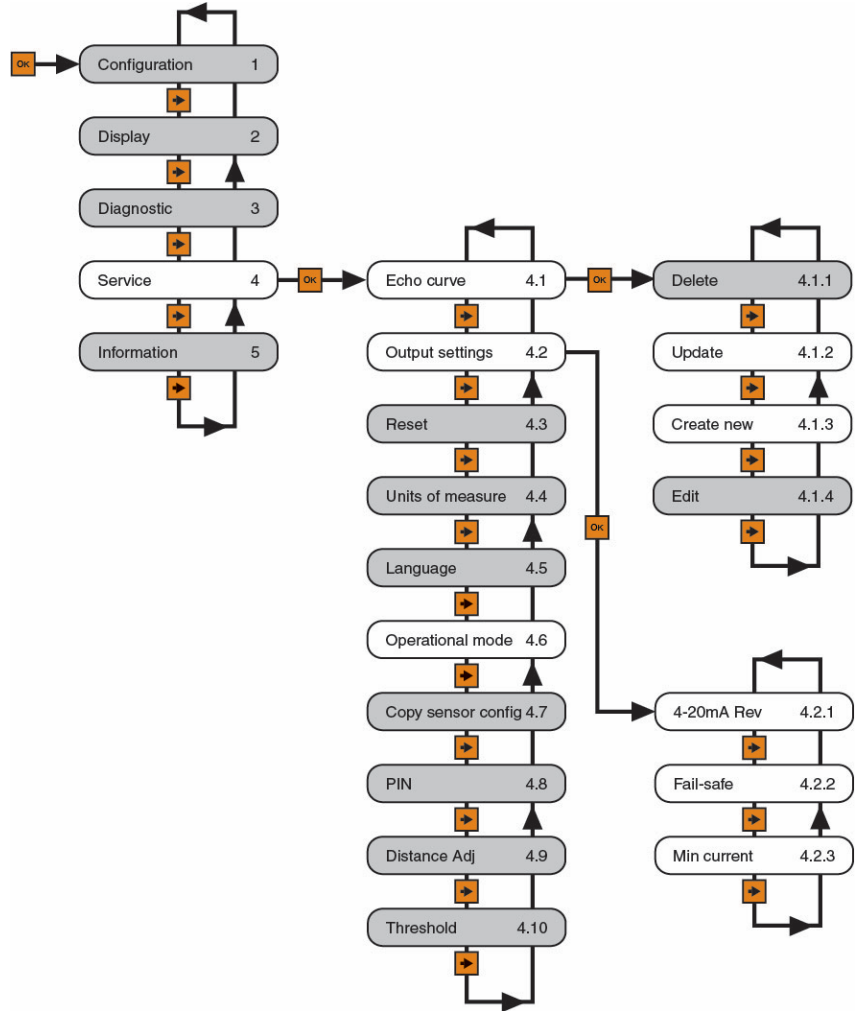

4-20 MA REVERSE OUTPUT

This function sets the current output at either 4-20 mA or 20-4 mA. Selecting 4-20 mA sets the output with 4mA @ bottom and 20mA @ top of the tank. This is the standard output used in the majority of applications. Selecting 20-4 mA sets the output with 20mA @ bottom and 4mA @ top of the tank. This is an optional output sometimes used in applications where the level is maintained at a high level.

- 1) From the Main Screen, press **OK** to advance into the Main Menu.
- 2) Press **Right Arrow** repeatedly until the arrow is next to Service.
- 3) Press **OK** to advance into Service Menu.
- 4) Press **Right Arrow** to move from Echo Curve to Output Current.
- 5) Press **OK** to advance into Output Current.
- 6) Press **OK** to advance into 4-20mA Rev.
- 7) Press **Right Arrow** to change the setting between 4-20mA and 20-4mA.
- 8) When the setting is correct, press **OK** to save.
- 9) When done, press **ESC** to return to the Service Menu and press **ESC** a second time to return to the Main Screen or; if you want to advance directly into Fail-Safe, press **OK** and then **Right Arrow** until Fail-Safe appears. When done, press **ESC** to return to the Service Menu and press **ESC** a second time to return to the Main Screen or; if you want to advance directly into Fail-Safe, press **OK** and then **Right Arrow** until Fail-Safe appears.

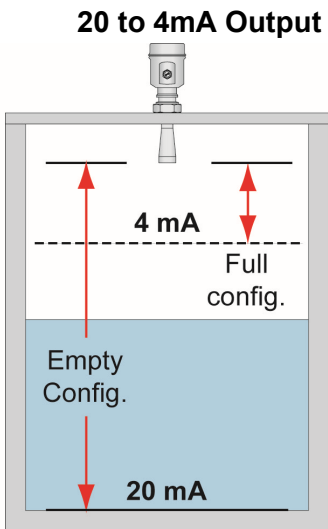
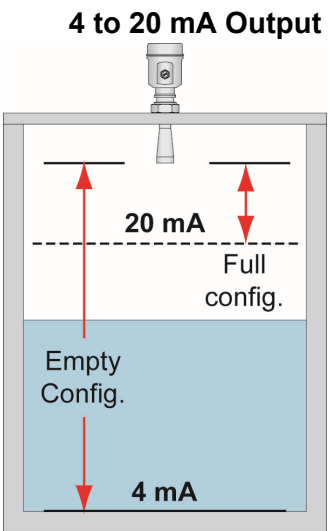
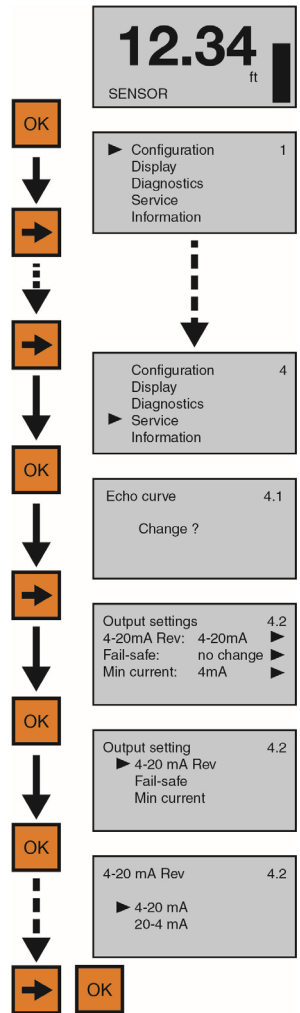

FAIL-SAFE OUTPUT

This function is used to set the current output to a designated state if the sensor loses measurement confidence. Selecting No Change will hold the current at its last valid current output. Selecting 20.5mA will force the current to jump to 20.5mA. Selecting 22.5 mA will force the current to jump to 22.5 mA. **Note:** The latter two high current output states are above the standard 4-20 mA operational range, and can be used to indicate that a failure has occurred.

- 1) From the Main Screen, press **OK** to advance into the Main Menu
- 2) Press **Right Arrow** repeatedly until the arrow is next to Service.
- 3) Press **OK** to advance into Service Menu and Echo Curve will appear.
- 4) Press **Right Arrow** to move from Echo Curve to Output Current.
- 5) Press **OK** to advance into Output Current menu.
- 6) Press **Right Arrow** to move from Reverse 4-20mA to Fail-safe.
- 7) Press **OK** to enter Fail-safe.
- 8) Press **Right Arrow** to change the setting between No change, 20.5mA and 22.0mA.
- 9) When the setting is correct, press **OK** to save.
- 10) When done, press **ESC** to return to the Service Menu and press **ESC** a second time to return to the Main Screen or; if you want to advance directly into Min Current, press **OK** and then **Right Arrow** until Min Current appears.

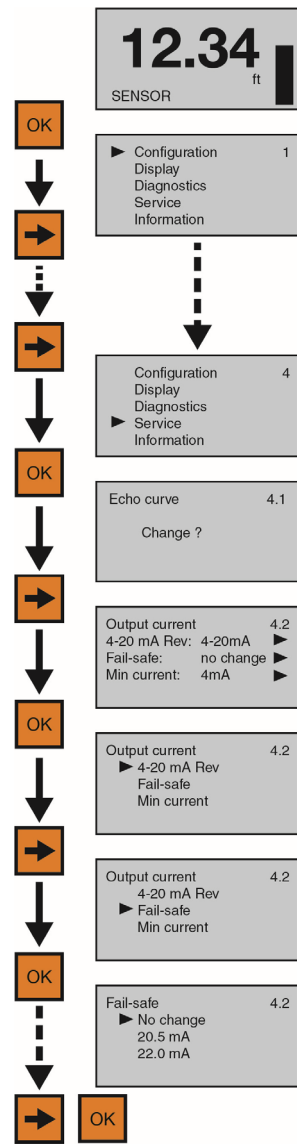

MINIMUM CURRENT OUTPUT

This function sets the minimum current output for the sensor at either 4.0mA or 3.9mA. **Note:** 4.0mA is the default minimum current output and is used in the majority of applications.

- 1) From the Main Screen, press **OK** to advance into the Main Menu.
- 2) Press **Right Arrow** repeatedly until the arrow is next to Service.
- 3) Press **OK** to advance into Service Menu and Echo Curve will appear.
- 4) Press **Right Arrow** to move from Echo Curve to Output Current.
- 5) Press **OK** to advance into Output Current menu.
- 6) Press **Right Arrow** repeatedly to move from Reverse 4-20mA to Min Current.
- 7) Press **OK** to enter Min Current.
- 8) Press **Right Arrow** to change the setting between 3.9mA and 4.0mA.
- 9) When the setting is correct, press **OK** to save.
- 10) When done, press **ESC** to return to the Service Menu and press **ESC** a second time to return to the Main Screen.

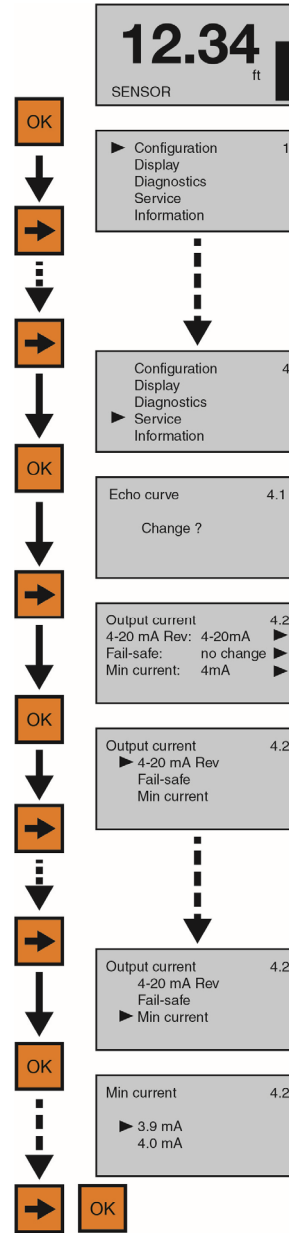

HART® OPERATION MODE

This feature sets the HART® address for operation as well as setting the output current for HART® operation.

- HART® Address
 - Standard – address 0 (default). Use in a single device per loop configuration.
 - Multi-drop – addresses 1 to 15. Allows for multiple sensors to share the same wiring. Each sensor must have a unique address. The current loop will hold when address is set from 1 to 15.
- HART® Current
 - Standard – 0 (default). 4-20 mA output is active when address is set to 0.
 - Multi-drop – Choose between 4mA or 8mA as the static current. Power supply must be able to provide power for all devices placed on the loop at the set current. Default is 4mA.

- 1) From the Main screen, Press **Enter** to enter Menu.
- 2) Press **Right Arrow** repeatedly until arrow is next to Service.
- 3) Press **Enter** to advance into Service menu.
- 4) Press **Right Arrow** repeatedly until HART® Operation Mode appears.
- 5) Press **Enter** to advance into HART® Operation Mode.
- 6) Press **Right Arrow** to move arrow next to Multi-Drop.
- 7) Press **Enter** to enter Multi-Drop and set the HART® address.
 - a) Use the **Up Arrow** to increase the value of the number highlighted.
 - b) Use the **Right Arrow** to move one segment to the right.
- 8) When the address is set, press **Enter** to save the new address and jump to Current.
 - a) Use the **Up Arrow** to change the current value between 4mA & 8mA.
 - b) When the current is set, press **Enter** to save the new current.

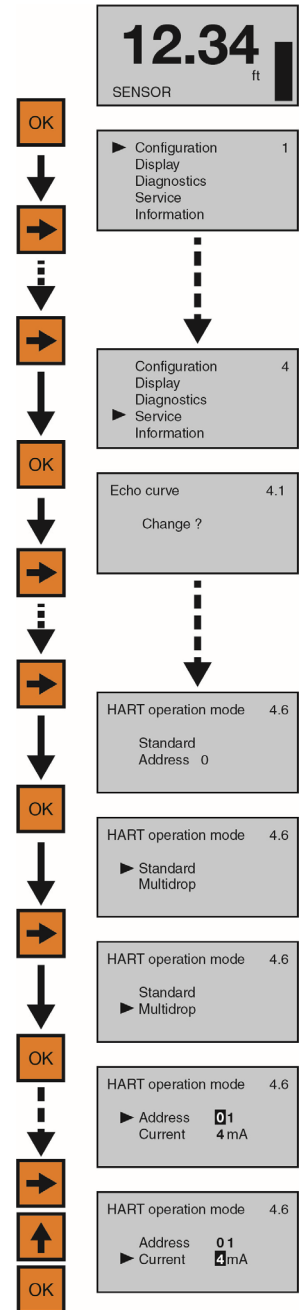

When the setting is correct for your application, press **Enter** again to return to HART® Operational Mode, press the **ESC** button to return to Service Menu and press **ESC** a second time to return to the Main screen.

CREATE A NEW FALSE ECHO CURVE

Obstructions in the tank (mixer blades, side wall weld joints or material build-up, submersible pumps, piping, other apparatus) or tall tank risers or installation fittings can create false echo returns that impair the sensor's measurement. This function maps all echo returns within the tank, differentiating between good and false echoes, and stores those identified as false into the False Echo Curve, so they will not be considered in the level measurement. **Note:** A False Echo Curve should only be performed when the tank is empty so that all false reflections will be detected. Before starting, measure and note the exact distance from the sensor's measurement location to the liquid surface. Setting the display to Distance will show the distance from the Sensor to the liquid surface. Enter this value under Step 6. Setting the distance value too large or too short can force the sensor into ignoring the true level.

- 1) From the Main Screen, press **OK** to advance into the Main Menu.
- 2) Press **Right Arrow** repeatedly until the arrow is next to Service.
- 3) Press **OK** to advance into Service Menu and Echo Curve will appear.
- 4) Press **OK** to make a change to the Echo Curve settings.
- 5) Press **Right Arrow** repeatedly until the arrow is next to Create New.
- 6) Press **OK** to advance into Create New. Enter the distance from the sensor's measurement location to the liquid surface.
- 7) Use the **Right Arrow** to move one segment to the right. The **Right Arrow** will scroll left to right and then back to the first segment.
- 8) When the value is correct, press **OK** to save the setting and begin the False Echo Curve mapping. The process may take a few minutes. When complete, the display will return to the Echo Curve screen.
- 9) When done, press **ESC** to return to the Service Menu and press **ESC** a second time to return to the Main Screen.
- 10) From the Main Screen, press **ESC** and the Echo Curve Screen will appear. Follow the Check Echo Curve procedure described at the end of Section Five to confirm that the sensor is performing correctly.

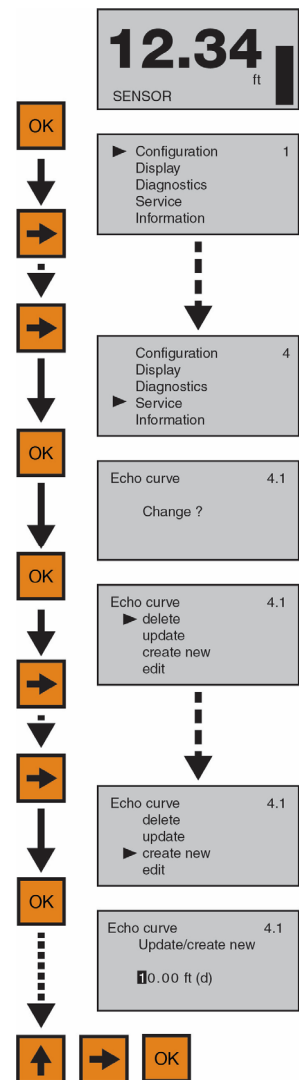

UPDATE AN EXISTING FALSE ECHO CURVE

This function enables an Existing False Echo Curve to be updated under the circumstances that the curve was created when the level was higher than an empty tank condition. **Note:** *This function should only be performed to update an Existing False Echo Curve when the level is BELOW the original False Echo Curve. Do not use this function to update an Existing False Echo Curve when the level is above the original False Echo Curve. Before starting, measure and note the exact distance from the sensor's measurement location to the liquid surface. Setting the distance value too large or too short can force the sensor into ignoring the true level.*

Original False Echo Curve

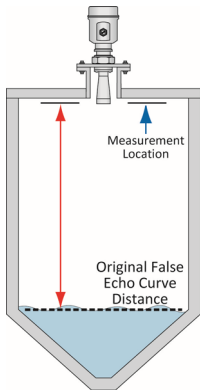

Good Update

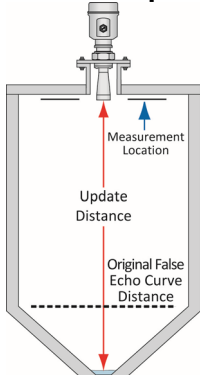

Bad Update

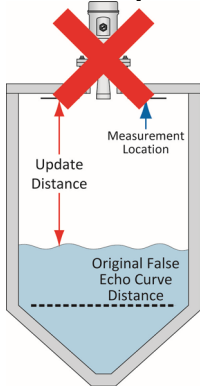

- 1) From the Main Screen, press **OK** to advance into the Main Menu.
- 2) Press **Right Arrow** repeatedly until the arrow is next to Service.
- 3) Press **OK** to advance into Service Menu and Echo Curve will appear.
- 4) Press **OK** to make a change to the Echo Curve settings.
- 5) Press **Right Arrow** repeatedly until the arrow is next to Update.
- 6) Press **OK** to advance into Update. Enter the actual distance from the sensor's measurement location to the liquid surface.
- 7) Use the **Right Arrow** to move one segment to the right. The **Right Arrow** will scroll left to right and then back to the first segment.
- 8) Use the **Up Arrow** to increase the value of the number highlighted. The **Up Arrow** will scroll from 0 to 9 and back again.
- 9) When the value is correct, press **OK** to save the setting and begin the False Echo Curve mapping. The process may take a few minutes. When complete, the display will return to the Echo Curve screen.
- 10) When done, press **ESC** to return to the Service Menu and press **ESC** a second time to return to the Main Screen.
- 11) From the Main Screen, press **ESC** and the Echo Curve Screen will appear. Follow the Check Echo Curve procedure described at the end of Section Five to confirm that the sensor is performing correctly.

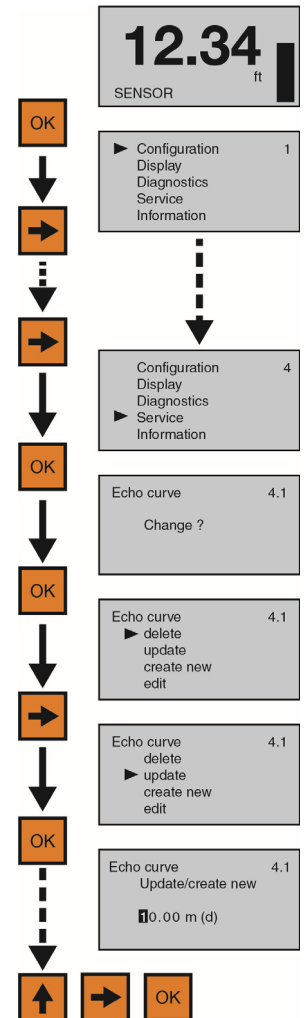

TROUBLESHOOTING OVERVIEW

These functions provide troubleshooting information; enable Echo Curve adjustments and deletion of settings.

- 1) Measurement Status
 - a) Displays the signal strength (dB) of the echo returns and the functional status of the sensor including diagnostic error codes.
- 2) Peak Values
 - a) Displays the lowest and highest level height that the sensor has measured in distance (d).
- 3) Simulation
 - a) Simulates the 4-20mA current output from percent of span, current or distance inputs.
- 4) First Echo Adjustment
 - a) Provides the ability to increase or decrease the peak signal strength of the First Echo return.
- 5) Echo Curve Zoom
 - a) Provides the ability to zoom in and magnify the Echo Curve over a specified range.
- 6) False Echo Curve Delete
 - a) Provides the ability to delete a saved False Echo Curve.
- 7) Reset
 - a) Provides the ability to reset configuration settings and memory.

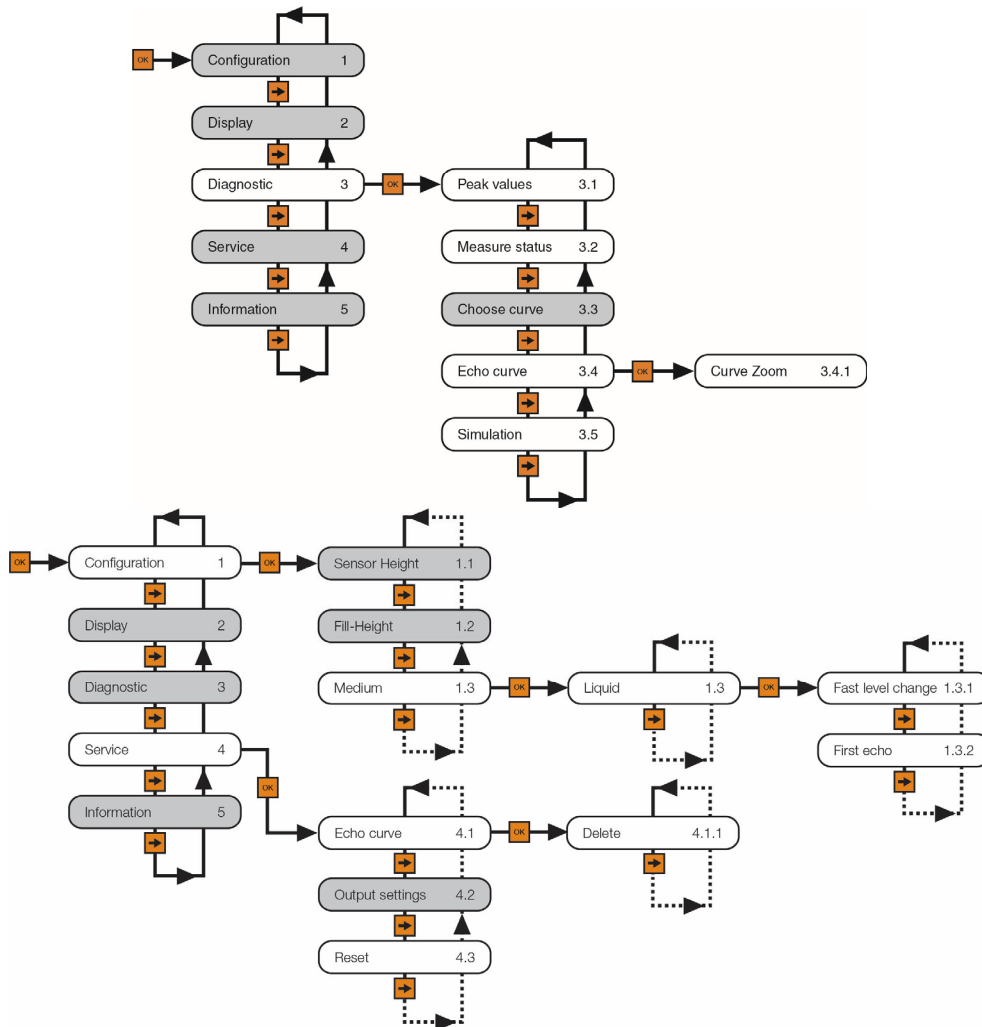

MEASUREMENT STATUS

This function displays the signal strength (dB) of the echo returns and the operational status of the sensor including diagnostic error codes.

- 1) From the Main Screen, press **OK** to advance into the Main Menu.
- 2) Press **Right Arrow** repeatedly until the arrow is next to Diagnostics.
- 3) Press **OK** to advance into Diagnostics.
- 4) Press **Right Arrow** to switch to Measurement Status.
- 5) Measurement reliability indicates the decibel (dB) strength of RF energy that’s reflecting back to the sensor less any noise. For reliable function, the dB value should be ≥ 10 dB.
- 6) Sensor status indicates the functional status of the sensor (either OK or error code)
- 7) When done, press **ESC** to return to the Service Menu and press **ESC** a second time to return to the Main Screen.

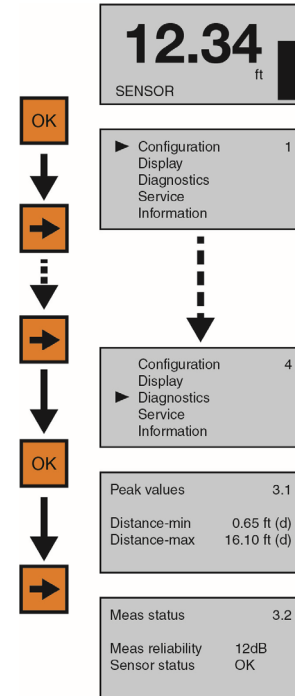

SENSOR STATUS ERROR CODES

Error Code	Problem	Solution
E11	Insufficient power	Check power supply
E12	Open circuit	Check wiring for open circuit
E14	Weak echo return (< 10dB)	Check for obstacles under the sensor, either clear the obstacle, move the sensor or perform a False Echo Curve
E15 or E17	ROM error	Contact your distributor

CURRENT OUTPUT CONDITIONS

Problem	Solution
Sensor output < 3.9mA	Check wiring for open circuit
Sensor output > 22mA	Check wiring for short circuit
Sensor output reaches 4mA before the tank is empty	Check the Empty Configuration setting, and if incorrect, extend the setting to the empty tank position
Sensor output will not reach 4mA	Check the Range setting, and if incorrect, extend the setting to or slightly below the Empty Configuration setting

PEAK VALUES

This function displays the lowest and highest level height that the sensor has measured in distance (d).

- 1) From the Main Screen, press **OK** to advance into the Main Menu.
- 2) Press **Right Arrow** repeatedly until arrow is next to Diagnostics.
- 3) Press **OK** to advance into Diagnostics and view Peak Values.
- 4) Distance-min is the lowest measured level and Distance-max is the highest measured level. Confirm that these values are within the sensor's operational range.
- 5) If the values appear too high or too low, check the tank for obstructions that could cause that problem.
- 6) When done, press **ESC** to return to the Service Menu and press **ESC** a second time to return to the Main Screen.

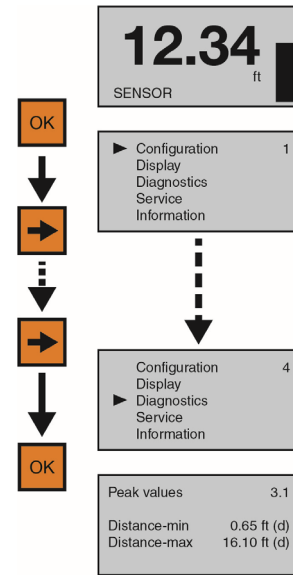

SIMULATION

This function simulates the 4-20mA current output, when the sensor is configured and installed on the tank, but the level cannot be changed easily for testing. Percent (of span), Current Output or Distance can be used as the input method to set the current output.

- 1) From the Main Screen, press **OK** to advance into the Main Menu.
- 2) Press **Right Arrow** repeatedly until the arrow is next to Diagnostics.
- 3) Press **OK** to advance into Diagnostics.
- 4) Press **Right Arrow** repeatedly until Simulation appears.
- 5) Press **OK** to advance into Simulation.
- 6) Use the **Right Arrow** to scroll among the three simulation methods (Percent, Current Out or Distance).
- 7) Use **OK** to select the method of simulation.
- 8) Upon selection of a method, the simulation will start and the current output will proportionately reflect the value shown. While the simulation is running, the value can be changed.
- 9) Use the **Right Arrow** to move one segment to the right. The **Right Arrow** will scroll left to right and then back to the first segment.
- 10) Use the **Up Arrow** to increase the value of the number highlighted. The **Up Arrow** will scroll from 0 to 9 and back again.
- 11) When the value is correct, press **OK** and the current output will reflect the value shown.
- 12) When done, press **ESC** to return to Simulation, press **ESC** again to return to the Configuration Menu, and press **ESC** a third time to return to the Main Screen.

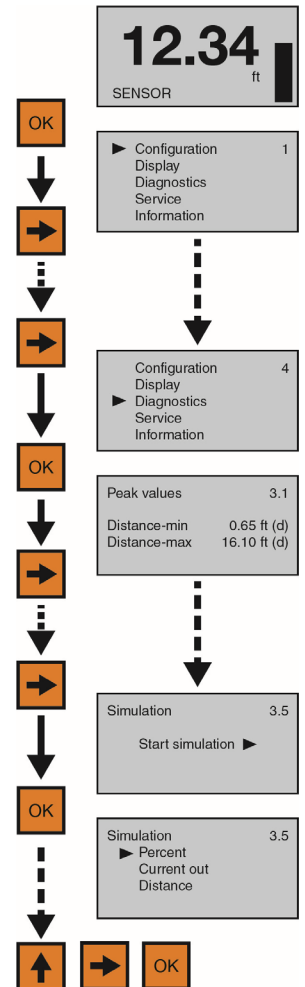

Percent

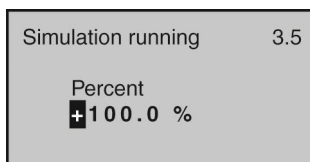

Current Output

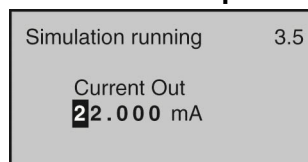

Distance

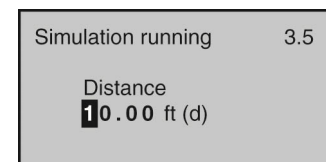

This method uses percentage of span (0-100%) to set the current output (4-20mA) between the Empty and Full Configuration values with 100% equal to 20 mA and 0% equal to 4mA.

This method directly sets the current output (4-20mA) to the desired value.

This method uses distance from the sensor's measurement location to set the current output (4-20mA) between the Empty and Full Configuration values.

FIRST ECHO ADJUSTMENT

This function increases or decreases the peak strength of the sensor's First Echo return, and should only be performed if: 1) The liquid has a very high dielectric constant value and primarily stays in the near full range of the tank, resulting in a very high First Echo peak strength or; 2) Process conditions, such as when the liquid has a very low dielectric constant value, or when obstructions, heavy foam or turbulence exist in the tank, resulting in little or no First Echo peak strength. **Note:** Under condition one (Example 1), it can be beneficial to decrease the First Echo peak strength. Under condition two (Example 3), it can be beneficial to increase the First Echo peak strength.

Example 1

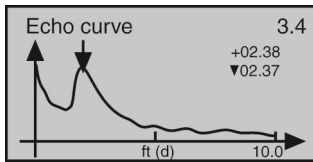

First Echo peak is very strong and can be reduced.

Example 2

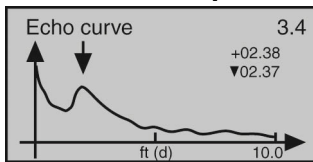

First Echo peak is normal and no adjustment is required.

Example 3

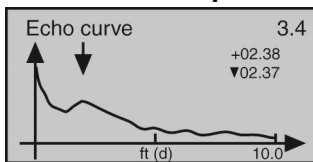

First Echo peak is weak and can be increased.

First Echo Adjustments

- Normal - No adjustment
- Small - Decrease by 10 dB
- Big - Increase by 10 db
- Bigger - Increase by 20 db
- Biggest - Increase by 40 db

- 1) From the Main Screen, press **OK** to advance into the Main Menu.
- 2) Press **OK** to advance into the Configuration Menu.
- 3) Press **Right Arrow** to move from Empty Configuration to Full Configuration.
- 4) Press **Right Arrow** to move from Full Configuration to Medium.
- 5) Press **OK** to advance into Medium and Liquid, Solid & Low Dielectric will appear.
- 6) Press **OK** to advance into Liquid and Fast Level Change will appear.
- 7) Press **Right Arrow** to move from Fast Level Change to First Echo.
- 8) Press **OK** to advance into First Echo.
- 9) Press **Right Arrow** to change the First Echo setting.
- 10) When setting is correct, press **OK** to save.
- 11) When done, press **ESC** to return to Medium, press **ESC** again to return to the Configuration Menu, and press **ESC** a third time to return to the Main Screen.

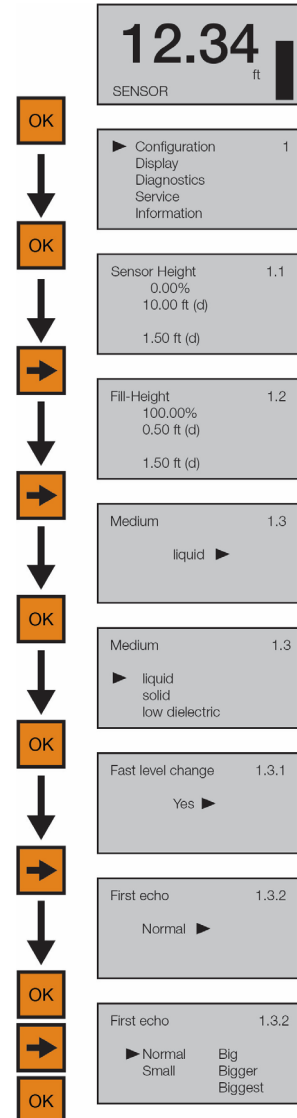

ECHO CURVE ZOOM

This function zooms in and magnifies an Echo Curve over a specified range.

- 1) From the Main Screen, press **OK** to advance into the Main Menu.
- 2) Press **Right Arrow** repeatedly until the arrow is next to Diagnostics.
- 3) Press **OK** to advance into Diagnostics.
- 4) Press **Right Arrow** repeatedly until Echo Curve appears.
- 5) Press **OK** to advance into Echo Curve.
- 6) Use the **Right Arrow** to scroll among the three settings (X-zoom, Y-zoom, Unzoom).
- 7) Press **OK** to select X-zoom.
- 8) Press **OK** to advance into the first X-zoom boundary (Example 1). Press **Right Arrow** to move the boundary to its desired location. Press **OK** to set the boundary and a second X-zoom boundary will appear.
- 9) Press **Right Arrow** to move the boundary to its desired location (Example 2). Press **OK** to set the boundary and the screen will show the expanded X-axis (Example 3). Press **ESC** to exit.
- 10) Press **OK** to advance into Y-zoom (Example 4). Press **Right Arrow** to move to the desired zoom magnification (Example 5). Press **OK** to set the zoom and the screen will show the expanded Y-axis (Example 6). **Note:** If you wish to start over, press **ESC**, return to Echo Curve, select Unzoom, and begin the procedure again.
- 11) When done, press **ESC** to return to Echo Curve, press **ESC** again to return to Diagnostics, and **ESC** a third time to return to the Main Screen.

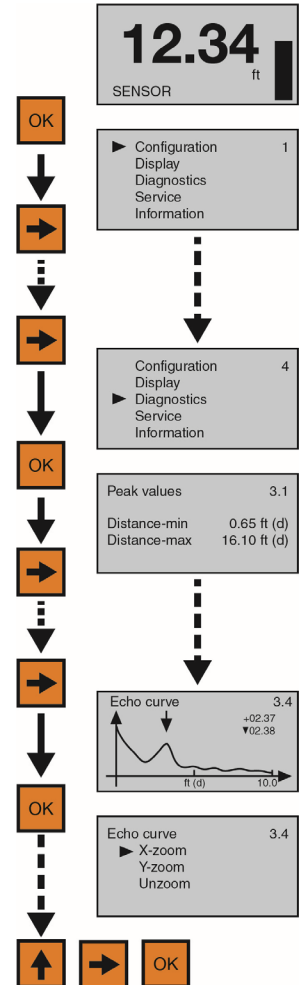

X-zoom (Example 1)

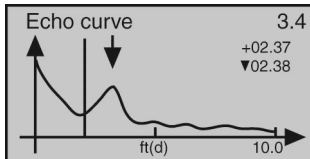

X-zoom (Example 2)

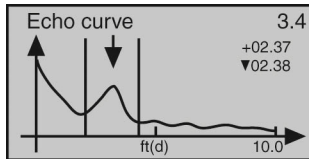

X-zoom (Example 3)

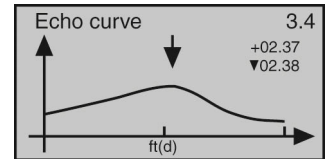

Y-zoom (Example 4)

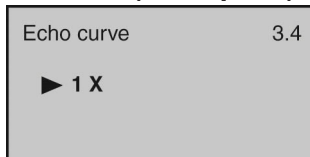

Y-zoom (Example 5)

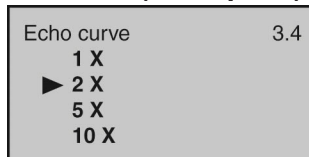

Y-zoom (Example 6)

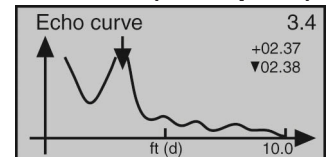

FALSE ECHO CURVE DELETE

This function deletes a saved False Echo Curve. **Note:** *If you are dissatisfied with the sensor's performance (operating with a False Echo Curve), you may delete it, and consider creating a new False Echo Curve.*

- 1) From the Main Screen, press **OK** to advance into the Main Menu.
- 2) Press **Right Arrow** repeatedly until the arrow is next to Service.
- 3) Press **OK** to advance into Service and Echo Curve will appear.
- 4) Press **OK** to make a change to Echo Curve.
- 5) Press **OK** to select Delete.
- 6) Press **OK** to Delete All.
- 7) Press **ESC** to return to Service and press **ESC** a second time to return to the Main Screen.

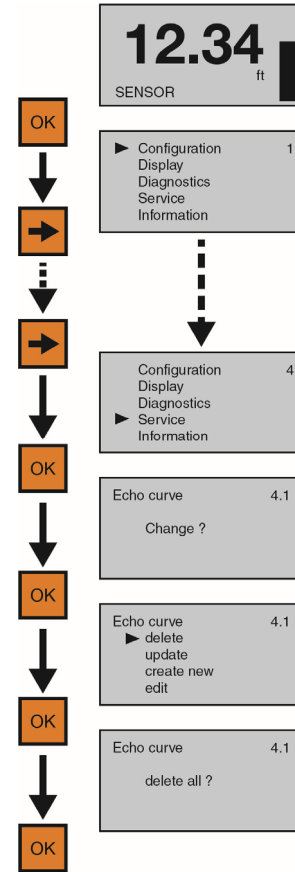

RESET

This function resets the sensor’s configuration (basic or factory) settings and memory (peak values measured).

- 1) From the Main Screen, press **OK** to advance into the Main Menu.
- 2) Press **Right Arrow** repeatedly until the arrow is next to Service.
- 3) Press **OK** to advance into Service.
- 4) Press **Right Arrow** repeatedly until Reset appears.
- 5) Press **OK** to advance into Reset.
- 6) Use the **Right Arrow** to scroll among the three reset types (Basic Reset, Factory Settings, Peak Value Meas).
 - a) Basic Reset
 - i) Resets basic configuration settings, process adjustment settings, and peak level values in memory (retaining any advanced adjustment settings).
 - b) Factory Settings
 - i) Resets ALL settings and memory to factory default.
 - c) Peak Values Measured
 - i) Resets the minimum and maximum peak level values in memory (retaining any basic configuration, process adjustment and advanced adjustment settings).
- 7) Use **OK** to select the desired type of reset.
- 8) When done, press **ESC** to return to Service, and press **ESC** a second time to the Main Screen.

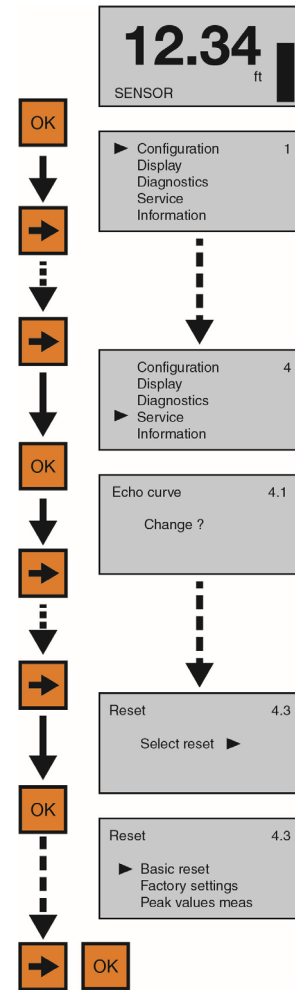

CONFIGURATION MENU

The basic configuration functions are found under Configuration. The below tree shows the 10 function settings and how to navigate between them.

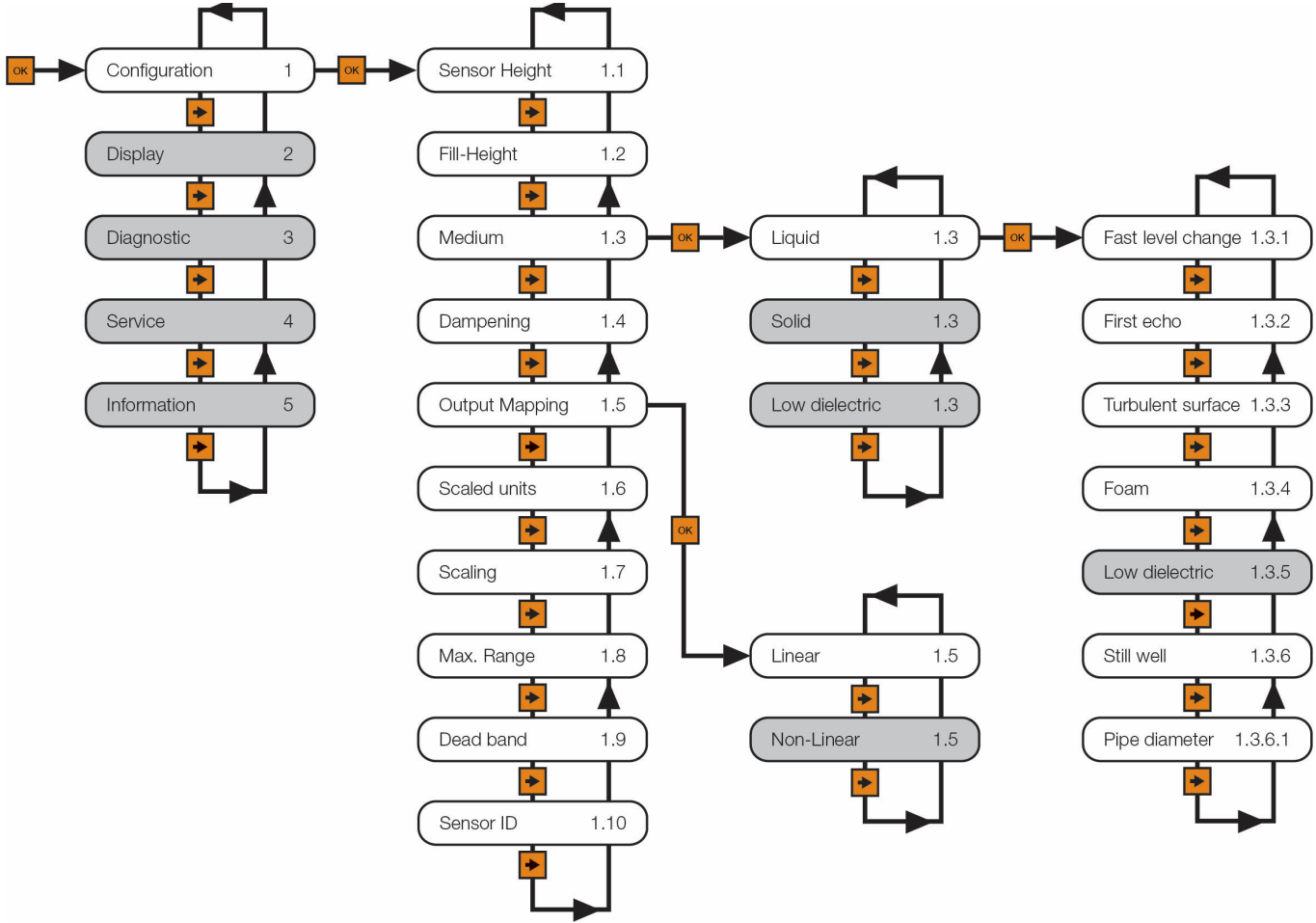

Note: Press **ESC** to back-up to the previous level.

EMPTY CONFIGURATION

This function adjusts the empty linear scaled current output (4mA) and provides two different adjustment methods:

- The primary method involves setting the value based upon the distance from the bottom of the sensor. This is a measured value using the units of operation for the sensor. For example, if the units of operation are in meters, then the setting must also be in meters.
- A second method involves setting a value based upon the percentage of the **Range** value. For example, if the **Range** is set to 10ft, then a 10% setting is equivalent to 1ft of liquid height or 9ft of air gap away from the sensor. **Note: Set the Range value before setting the Empty Configuration value.**

Sensor Height	1.1
0.00%	
25.00 ft (d)	
21.50 ft (d)	

Shows the percentage of empty based upon the **Range** setting.
Shows the distance from the bottom of the sensor to the empty tank.

Shows the air gap distance from the liquid to the bottom of the sensor.

FULL CONFIGURATION

This function adjusts the full linear scaled current output (20mA) and provides two different adjustment methods:

- The primary method involves setting the value based upon the distance from the 0% level setting (see below). This is a measured value using the units of operation for the sensor. For example, if the units of operation are in meters, then the setting must also be in meters.
- The second method involves setting a value based upon the percentage of the **Range** value. For example, if the **Range** is set to 10ft, then a 95% setting is equivalent to 9.5ft of liquid height or 0.5ft of air gap away from the sensor. **Note: Set the Range value before setting the Full configuration value.**

Fill-Height	1.2
100.00%	
01.50 ft (d)	
01.75 ft (d)	

Shows the percentage of full based upon the **Range** setting.
Shows the distance from the bottom of the sensor to the full tank.

Shows the air gap distance from the liquid to the bottom of the sensor.

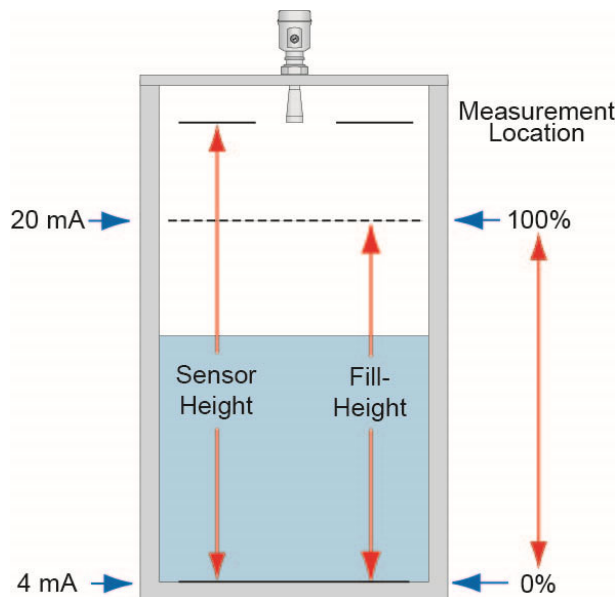

MEDIUM

This function identifies the type of media that the sensor is measuring including Liquid, Solid or Low Dielectric. Each has various settings to address the different reflective properties associated with each medium. **Default is Liquid.**

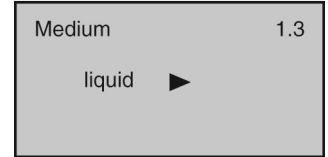

The **Liquid Medium** function has the following settings:

- **Fast Level Change** - Used when the media's level rise or fall within the tank is greater than a rate of 1" per second (25.4mm/sec). Selections are YES or NO. **Default is NO.**

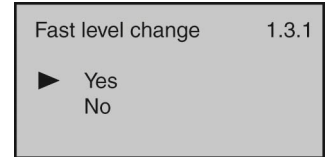
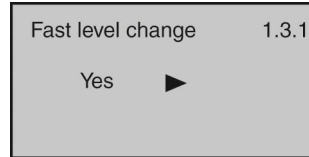

- **First Echo** - Used when the sensor has difficulty seeing the first echo return. This setting adjusts the peak strength (dB) of the first echo. **Default is Normal.** Below are the settings:

- **Normal** - No adjustment
- **Small** - Decreases by 10dB
- **Big** - Increases by 10dB
- **Bigger** - Increases by 20dB
- **Biggest** - Increases by 40dB

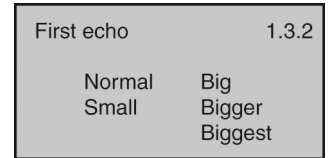
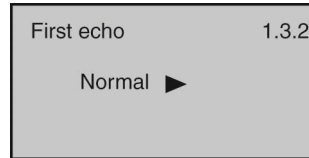

- **Turbulent Surface** - Used when the surface of the liquid is turbulent or agitated. Selections are YES or NO. **Default is NO.**

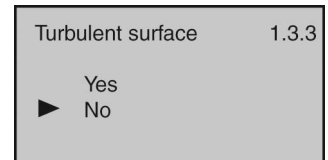
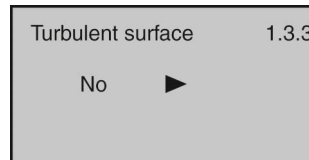

- **Foam** - Used when the entire liquid surface is covered with foam. Selections are YES or NO. **Default is NO.**

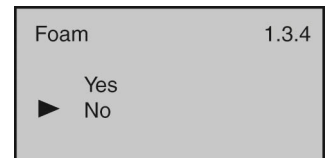

- **Low Dielectric** - Used when the liquid has a low dielectric constant (*and should not be performed without first consulting with the factory*). Selections are YES or NO. **Default is NO.**

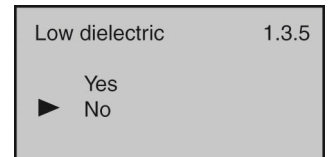

- **Still Well** - Used when the sensor is installed in a still well, stand pipe or sight glass. Selections are YES or NO. **Default is NO.** *Note: If YES is selected, the pipe (inner) diameter must be entered.*

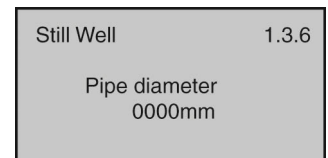
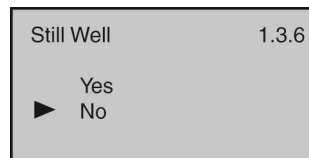
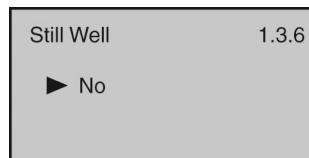

The **Solid Medium** function has the following settings (*and should not be performed without first consulting with the factory*):

- **Fast Level Change** - Used when the media's level rise or fall within the tank is greater than a rate of 1" per second (25.4mm/sec). Selections are YES or NO. **Default is NO.**
- **First Echo** - Used when the sensor has difficulty seeing the first echo return. This setting adjusts the peak strength (dB) of the first echo. **Default is Normal.** Below are the settings:
 - **Normal** - No adjustment
 - **Small** -Decreases by 10dB
 - **Big** - Increases by 10dB
 - **Bigger** - Increases by 20dB
 - **Biggest** - Increases by 40dB
- **Large Repose Angle** - Used when the repose angle of the material is steep. Repose angle is the steepest angle of assent or descent relative to the horizontal plane that a material can be piled without sliding. The repose angle varies between different materials. Selections are Yes or No. **Default is No.**
- **Powder / Dust** - Used when powder or dust are present in the atmosphere above the material. Selections are Yes or No. **Default is No.**
- **Low Dielectric** - Used when the material has a low dielectric constant (*and should not be performed without first consulting with the factory*). Selections are YES or NO. **Default is NO.**

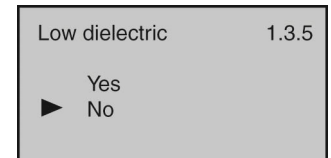
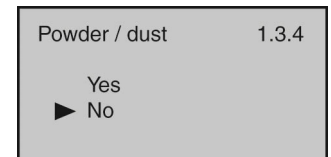
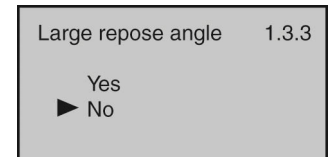
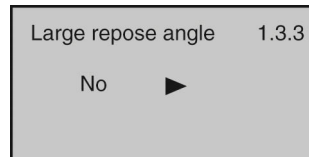
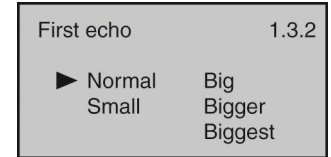
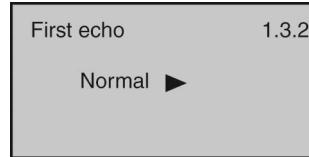
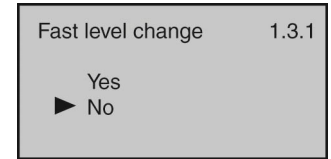
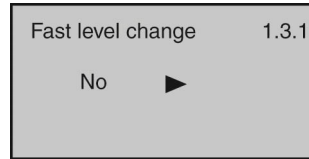

The **Low Dielectric Medium** function has the following settings (*and should not be performed without first consulting with the factory*):

When the dielectric constant of the media is ≤ 4 , the amplitude of the direct echo from the media may be low and difficult to detect. However, by measuring the echo reflected from the bottom of the tank, the liquid level can be measured. Two parameters must be input to complete the setup: 1) Distance from the bottom of the sensor to the tank bottom (Empty Span) and; 2) Distance from the tank bottom to the liquid level (True Level).

- **Empty Span** - Distance from the bottom of the sensor to the tank bottom.
- **True Level** - Distance from the tank bottom to the liquid level.
- **DK** - Media dielectric constant (determined by sensor).

Micro DK setup	1.3.1
Empty Span	25.00 ft
True Level	15.25 ft
DK	1.40
	09.75 ft(d)

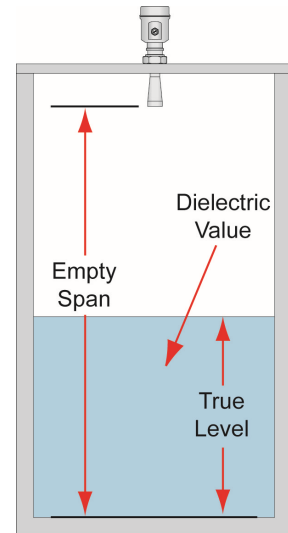

Note: Once this feature has been activated, only a factory setting can undo its activation. A factory reset will erase all active settings including Echo Curves.

DAMPEN

This function sets the sampling rate for which the sensor updates the current output. The value is entered in seconds. **Default is 6 seconds.**

- Decreasing the value will make the output more responsive to level changes.
- Increasing the value will make the output less responsive to level changes.

Dampening	1.4
6 sec	

OUTPUT MAPPING

This function sets the correlation between the measured value and the current output. Selections are Linear or Non-Linear. **Default is Linear.**

- Keep the setting on Linear. **Note:** This setting should not be changed without first consulting with the factory.

Output mapping	1.5
Linear ▶	

SCALED UNITS

This function sets the type of measurement (Height, Volume, Mass, Flow or No-Units) and units of measurement (which vary based upon the type of measurement) displayed and input during configuration. **Default is Height in Units of feet (ft).**

Scaled units	1.6
Height ▶	
ft ▶	

Scaled units	1.6
▶ Height	Volume
Mass	No-units
Flow	

Scaled units	1.6
m	cm
▶ ft	mm
in	

Scaled units	1.6
Height	▶ Volume
Mass	No-units
Flow	

Scaled units	1.6
m3	ft3
l	in3
hl	▶ gal

SCALING

This function sets the span values for 0% and 100% as an alternative method of adjusting the **Empty Configuration** and **Full Configuration** settings. **Defaults are 0% and 100%.**

Scaling	1.7
0% =	0.50 ft
100% =	15.00 ft

RANGE

This function sets the maximum range that the sensor can measure which is typically the distance from the bottom of the sensor to the empty tank bottom. **Default is the maximum range of the sensor.**

Max. Range	1.8
	32.81 ft (d)

DEAD BAND

This function sets the dead band or the minimum distance that the sensor will measure. **Default is 12" (30cm).** Minimum setting is 2" from the bottom of the antenna. *Consult factory when setting the dead band less than the factory setting.*

Dead band	1.9
	1.00 ft (d)

SENSOR ID

This function sets an 11-digit identification code. The setting can use alphanumeric values from A to Z and 0 to 9. **Default is the sensor's 4-digit Series number.**

Sensor ID	1.10
	Sensor

DISPLAY MENU

This menu sets the **Display Value** and **LCD Contrast**. The below tree shows the 2 function settings and how to navigate between them.

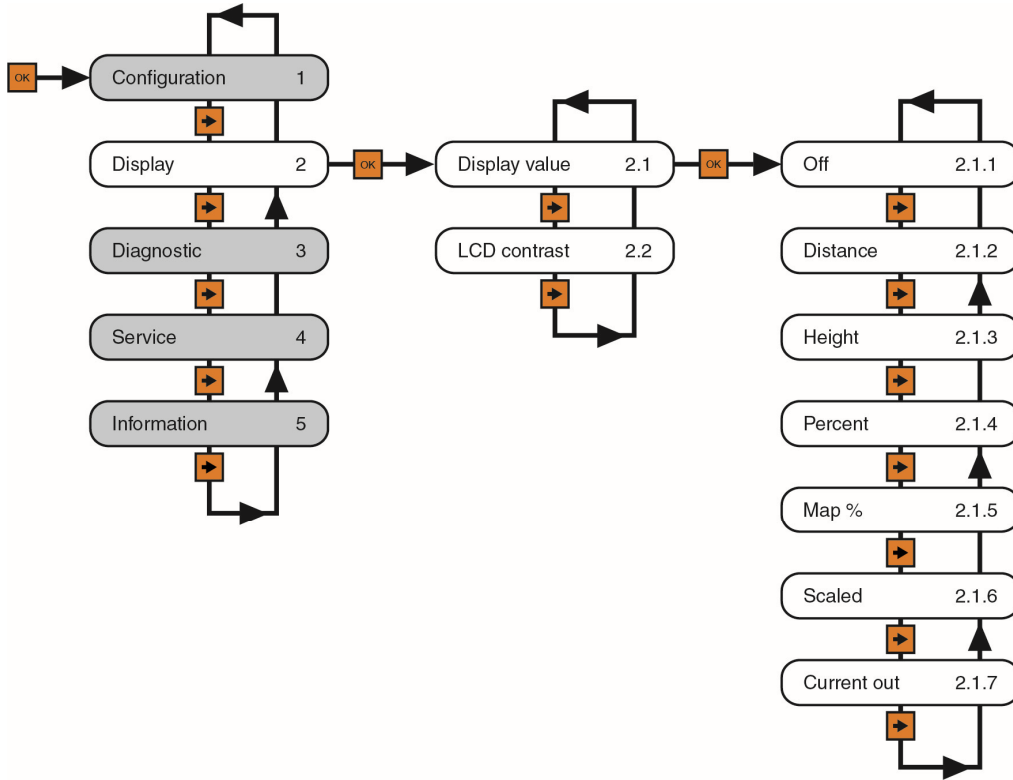

DISPLAY VALUE

This function sets the **Display Value**. **Default is (air gap) Distance**. Below are the settings:

- **OFF** - Turns the display OFF.
- **Distance** - Displays the distance from the bottom of the sensor to the liquid surface.
- **Height** - Displays the height of media in the tank from the **Maximum Range Setting**.
- **Percent Span** - Displays the level based on its percentage of operational span.
- **Map Percentage** - Displays the level based on its percentage of operational range.
- **Scaled** - Displays the level based on a scaled value between 0 (empty) and 10 (full).
- **Current Output** - Displays the 4-20 mA current output.

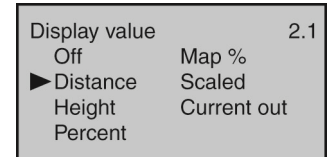
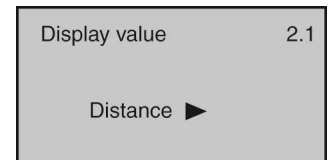

LCD CONTRAST

This function sets the B/W display contrast. Press the **Up Arrow** to increase the contrast, and press the **Right Arrow** to decrease the contrast.

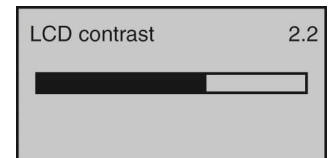
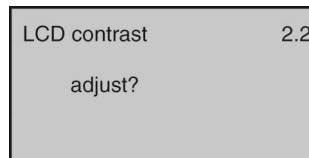

DIAGNOSTICS MENU

This menu provides information about the operational status of the sensor and diagnostic tools. The below tree shows the 5 function settings and how to navigate between them.

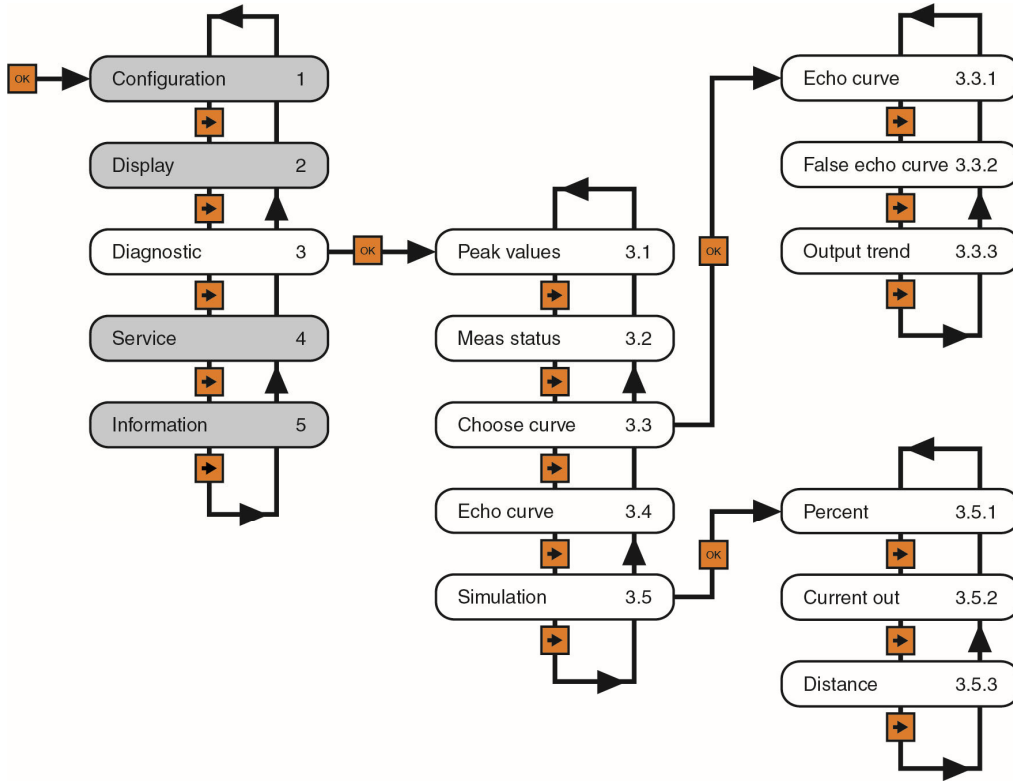

PEAK VALUES

This function displays the lowest and highest level height distances (d) that the sensor has measured during operation. To reset these values, use the Reset >> Peak Measured Values option found under the Service Menu.

Peak values	3.1
Distance-min	0.65 ft (d)
Distance-max	16.10 ft (d)

MEASUREMENT STATUS

This function displays the signal strength (dB) of the echo returns (Measurement Reliability) and the operational status of the sensor (Sensor Status). A signal strength of 10dB or higher is acceptable. Anything under 10dB is considered a weak signal. The cause of a weak signal is often obstructions within the beam path or a poor installation.

Meas status	3.2
Meas reliability	10dB
Sensor status	OK

Sensor status confirms whether the sensor is operating as expected. If normal, the descriptor will be OK. If abnormal, the descriptor will be one of the following error codes:

- E11** – Insufficient power error
- E12** – Sensor open circuit
- E14** – Weak return echo
- E15** – ROM error
- E17** – ROM error

CHOOSE CURVE

This function sets which information is displayed.

Default is Echo Curve.

- Echo Curve - Shows the echo return energy received by the sensor over distance.
- False Echo Curve - Shows the false echo returns which are mapped out (not considered) by the sensor.
- Output Trend - Shows recent history of where the past level readings have occurred.

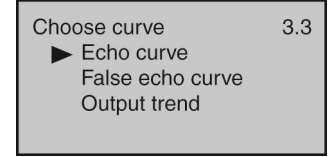
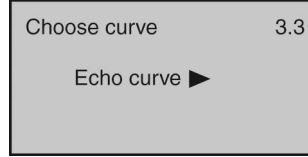

ECHO CURVE

This function shows the Echo Curve and allows the user to zoom in and magnify information along the X-axis and Y-axis.

- X-zoom - Expands echo information along the X-axis. Used to determine the location of an echo.
- Y-zoom - Expands echo information along the y-axis. Used to determine the energy of an echo.
- Unzoom - Returns the display to the original setting.

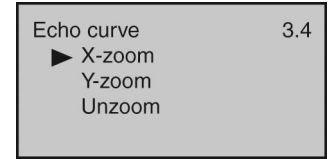
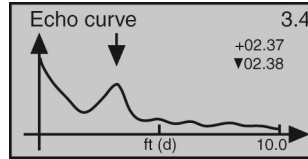

SIMULATION

This function sets a fixed 4-20mA current output from the sensor for purposes of testing devices receiving information from the sensor. The simulated current output may be set with the below three input methods:

- Percent - This method uses percentage of span (0-100%) to set the current output (4-20mA) between the Empty and Full Configuration values with 100% equal to 20 mA and 0% equal to 4mA.
- Current Out - This method directly sets the current output (4-20mA) to the desired value.
- Distance - This method uses distance from the sensor's measurement location to set the current output (4-20mA) between the Empty and Full Configuration values.

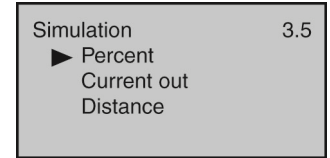
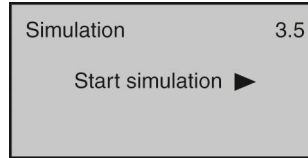

SERVICE MENU

This menu is used to make more advanced adjustments to the sensor. **Note:** Some of these functions should only be performed by a trained technician.

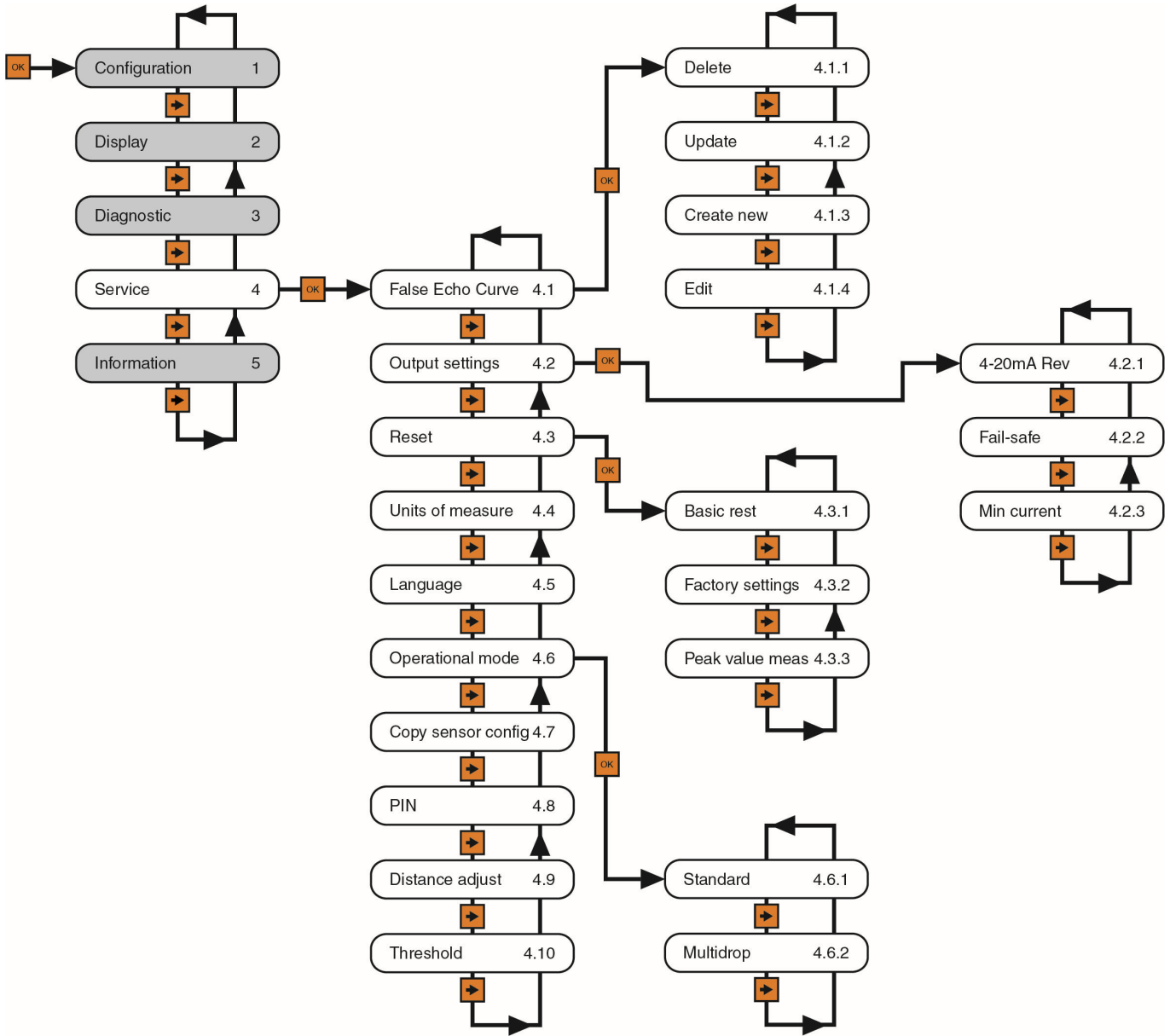

FALSE ECHO

Obstructions in the tank (mixer blades, side wall weld joints or material build-up, submersible pumps, piping, other apparatus) or tall tank risers or installation fittings can create false echo returns that impair the sensor’s measurement. This function maps all echo returns within the tank, differentiating between good and false echoes, and stores those identified as false into the False Echo Curve, so they will not be considered in the level measurement. **Note:** A False Echo Curve should only be performed when the tank is empty so that all false reflections will be detected.

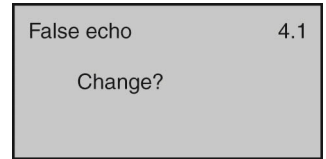

This function allows the selection of the below False Echo Curve settings:

- Delete - Used to remove a stored False Echo Curve.
- Update - Used to update a stored False Echo Curve.

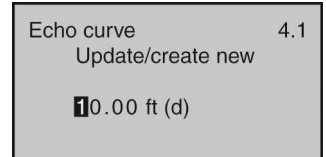

- **Note:** Do not use this function to update an existing False Echo Curve when the level is above the original False Echo Curve.

Create New - Used to create a new False Echo Curve.

- Edit - Used to edit the false echoes stored in a False Echo Curve. **Note:** This function should only be performed by a trained technician.

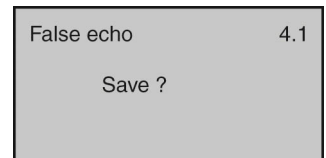
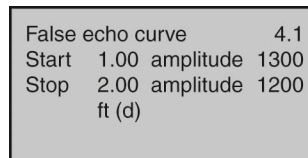
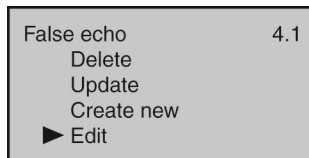

OUTPUT SETTINGS

This function allows the selection of the below of 4-20mA Reverse, Fail-Safe and Minimum Current output settings. The initial screen indicates the status of the three functions.

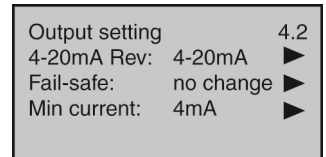

- 4-20 mA Reverse - Used to set the current output at 4-20 mA or 20-4 mA. Selecting 4-20 mA sets the output with 4mA @ bottom and 20mA @ top of the tank. Selecting 20-4 mA sets the output with 20mA @ bottom and 4mA @ top of the tank. **Default is 4-20mA.**

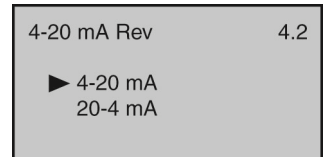

- Fail-Safe – Used to set the current output to a designated if the sensor loses measurement confidence. Selecting No Change will hold the current at its last valid current output. Selecting 20.5mA will force the current to jump to 20.5mA. Selecting 22.5 mA will force the current to jump to 22.5 mA. **Default is 22.0mA.**

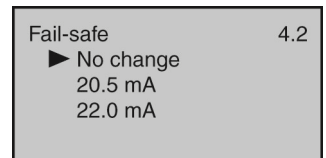
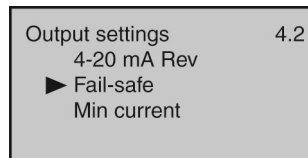

- Minimum Current - Used to set the minimum current output at either 4.0mA or 3.9mA. **Default is 4.0mA.**

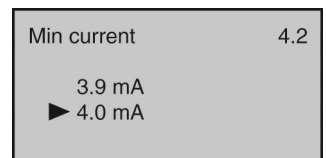
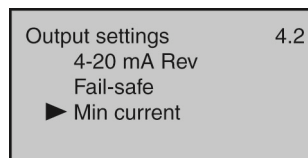

RESET

This function allows the configuration (basic or factory) settings and memory (peak values measured) to be reset. Below are the three reset types:

- Basic Reset – Used to reset the basic configuration settings, process adjustment settings, and peak level values in memory (retaining any advanced adjustment settings).
- Factory Settings – Used to reset ALL settings and memory to factory default.

Note: Only perform the Factory Setting after consulting with a Flowline Representative. Make sure to record all of your settings including the Distance Adjustment (4.9) setting before performing the Factory Reset.

- Peak Values Measured – Used to reset the minimum and maximum peak level values in memory (retaining any basic configuration, process adjustment and advanced adjustment settings).

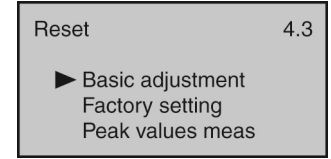
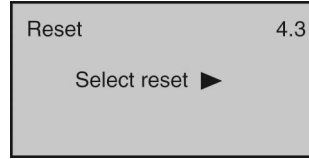

UNITS OF MEASUREMENT

This function allows the units of measurement to be changed between Metric and English system units.

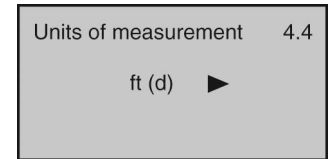

LANGUAGE

This function sets the display language. **Default is English.**



HART® OPERATIONAL MODE

This function allows for the sensor's HART® address to be changed from the Standard mode with an address of 0 to a Multidrop mode where the address can be set from 1 to 15. **Default is Address 0.** *Note: This function should only be performed by a trained technician.*

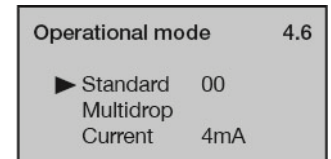
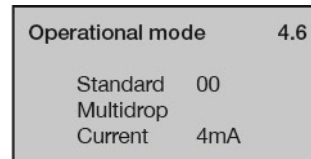

This function allows for the loop consumption (constant current draw) to be set to either 4mA or 8mA. **Default is 4mA.**

COPY SENSOR DATA

This function allows configuration and memory data to be uploaded to or downloaded from the sensor. *Note: This function should only be performed by a trained technician.*

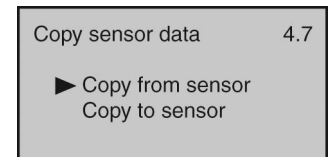
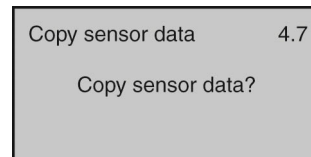

PIN

This function allows the sensor configuration to be locked via a preset PIN. **Note:** *This function should only be performed by a trained technician.*

PIN	4.8
Enable?	

PIN	4.8
Cancel?	

DISTANCE ADJUSTMENT

This function allows the factory set distance of a measured value to be adjusted. **Note:** *This function should only be performed by a trained technician. Never change this setting unless instructed by a Flowline representative. Be sure to record this setting if a Factory reset is performed.*

Distance adjustment	4.9
+0.00 ft (d)	

THRESHOLD

This function allows the factory set echo threshold to be adjusted. **Note:** *This function should only be performed by a trained technician.*

Threshold	4.10
Echo threshold	60
Envelope level	10

INFORMATION

This function displays basic information about your sensor including sensor type, serial number, date of manufacture and software version.

Sensor type	5.1
LR15	
Serial number	
123456	

Date of manufacture	5.2
2014-07-01	
Software version	
14.05.01	

FACTORY SETTINGS

Below are the Empty Configuration and Full Configuration factory settings for each sensor.

Series	Sensor Height (4mA)	Fill-Height (20mA)
LR11	32.81' (10m)	31.17' (9.5m)
LR16	98.42' (30m)	96.78' (29.5m)
LR21	65.61' (20m)	63.98' (19.5m)
LR26	114.83' (35m)	113.19' (34.5m)
LR31	94.82' (30m)	96.78' (29.5m)

USER CONFIGURATION

Fill out the below chart and keep a record of your sensor configuration.

Configuration

Units of Measurement:	Feet	Meters
Empty Configuration:	Full Configuration:	
Range (Maximum):	Dead Band:	

Process / Advanced Adjustments

Foam:	No	Yes	Agitated Surface:	No	Yes
Fast Level Change:	No	Yes	Low Dielectric:	No	Yes
Still Well:	No	Yes	Diameter:		
Dampening Time:	_____				
First Echo:	Normal	Small	Big	Bigger	Biggest

TROUBLESHOOTING

Subject	Comment
Display Shows E14:	Sensor is in a Fail-Safe state. The return sound pulses are not reaching the transducer. First, cycle power off and on, waiting 5 seconds between the off and on states. If problem persists, check the installation fitting against the Installation instructions in the manual.
Display is opposite of the measured value:	Check the Display Value setting (2.1). Distance mode indicates the distance from the liquid to the sensor. Height mode indicates the height of liquid in the tank. Change the Display Value from Distance to Height or vice versa to correct. This setting does not affect the 4-20mA output.
Transmitter indicates a current of 0 mA:	Check the wiring for an open circuit. An open circuit is the most common issue with a 0 mA signal.
Transmitter jumps to a current reading between 19 and 20 mA:	Check the installation of the transmitter. Bad installation fittings will cause false signals near the top of the tank, which typically translates to a signal between 19 and 20 mA. Also look for interference just below the transmitter. If the transmitter is installed in a metal fitting, switch to a plastic fitting.
Transmitter indicates a current over 23 mA:	Immediately check the wiring for a short circuit. The EchoPulse® is current limited to 22 mA. Anything above 23 mA indicates a short circuit.
Time Out Error Occurred on Command Zero	Check that VDC power is being applied to the sensor when using WebCal®. The Radar Power LED should be blue with power. If it is OFF, then power is not being applied. If power is applied, click on Try Again to re-connect to WebCal®.

WARRANTY

Flowline warrants to the original purchaser of its products that such products will be free from defects in material and workmanship under normal use and service in accordance with instructions furnished by Flowline for a period of two years from the date of manufacture of such products. Flowline's obligation under this warranty is solely and exclusively limited to the repair or replacement, at Flowline's option, of the products or components, which Flowline's examination determines to its satisfaction to be defective in material or workmanship within the warranty period. Flowline must be notified pursuant to the instructions below of any claim under this warranty within thirty (30) days of any claimed lack of conformity of the product. Any product repaired under this warranty will be warranted only for the remainder of the original warranty period. Any product provided as a replacement under this warranty will be warranted for the full two years from the date of manufacture.

RETURNS

Products cannot be returned to Flowline without Flowline's prior authorization. To return a product that is thought to be defective, go to www.flowline.com, and submit a customer return (MRA) request form and follow the instructions therein. All warranty and non-warranty product returns to Flowline must be shipped prepaid and insured. Flowline will not be responsible for any products lost or damaged in shipment.

LIMITATIONS

This warranty does not apply to products which: 1) are beyond the warranty period or are products for which the original purchaser does not follow the warranty procedures outlined above; 2) have been subjected to electrical, mechanical or chemical damage due to improper, accidental or negligent use; 3) have been modified or altered; 4) anyone other than service personnel authorized by Flowline have attempted to repair; 5) have been involved in accidents or natural disasters; or 6) are damaged during return shipment to Flowline. Flowline reserves the right to unilaterally waive this warranty and dispose of any product returned to Flowline where: 1) there is evidence of a potentially hazardous material present with the product; or 2) the product has remained unclaimed at Flowline for more than 30 days after Flowline has dutifully requested disposition. This warranty contains the sole express warranty made by Flowline in connection with its products. ALL IMPLIED WARRANTIES, INCLUDING WITHOUT LIMITATION, THE WARRANTIES OF MERCHANTABILITY AND FITNESS FOR A PARTICULAR PURPOSE, ARE EXPRESSLY DISCLAIMED. The remedies of repair or replacement as stated above are the exclusive remedies for the breach of this warranty. IN NO EVENT SHALL FLOWLINE BE LIABLE FOR ANY INCIDENTAL OR CONSEQUENTIAL DAMAGES OF ANY KIND INCLUDING PERSONAL OR REAL PROPERTY OR FOR INJURY TO ANY PERSON. THIS WARRANTY CONSTITUTES THE FINAL, COMPLETE AND EXCLUSIVE STATEMENT OF WARRANTY TERMS AND NO PERSON IS AUTHORIZED TO MAKE ANY OTHER WARRANTIES OR REPRESENTATIONS ON BEHALF OF FLOWLINE. This warranty will be interpreted pursuant to the laws of the State of California. If any portion of this warranty is held to be invalid or unenforceable for any reason, such finding will not invalidate any other provision of this warranty.

For complete product documentation, video training, and technical support, go to www.flowline.com.

For phone support, call 562-598-3015 from 8am to 5pm PST, Mon - Fri.

(Please make sure you have the Part and Serial number available.)