

Operating Instructions

Proline Promag H 10

Electromagnetic flowmeter
HART



Table of contents

1	About this document	6	8	Commissioning	62
	Document function	6		Post-installation check and post-connection check	62
	Associated documentation	6		IT security	62
	Symbols	7		Device-specific IT security	62
	Registered trademarks	9		Switching on the device	63
				Commissioning the device	64
2	Safety instructions	12	9	Operation	68
	Requirements for specialist personnel	12		Reading the device locking status	68
	Requirements for operating personnel	12		HistoROM data management	68
	Incoming acceptance and transport	12	10	Diagnostics and troubleshooting	70
	Adhesive labels, tags and engravings	12		General troubleshooting	70
	Environment and process	12		Diagnostic information via LED	72
	Occupational safety	12		Diagnostic information on local display	73
	Installation	12		Diagnostic information in FieldCare or DeviceCare	74
	Electrical connection	12		Changing the diagnostic information	75
	Surface temperature	13		Overview of diagnostic information	76
	Commissioning	13		Pending diagnostic events	79
	Modifications to the device	13		Diagnostic list	80
				Event logbook	80
				Device reset	82
3	Product information	16	11	Maintenance	84
	Measuring principle	16		Maintenance tasks	84
	Designated use	16		Services	84
	Incoming acceptance	16	12	Disposal	86
	Product identification	17		Removing the device	86
	Transport	19		Disposing of the device	86
	Checking the storage conditions	21	13	Specifications	88
	Recycling of packaging materials	21		Input	88
	Product design	22		Output	90
	Firmware history	24		Power supply	94
	Device history and compatibility	24		Cable specification	96
				Performance characteristics	97
				Environment	99
				Process	101
				Mechanical construction	106
				Local display	109
				Certificates and approvals	110
				Application packages	111
4	Installation	26	14	Dimensions in SI units	114
	Installation conditions	26		Compact version	114
	Installing the device	30		Remote version	115
	Post-installation check	34		Sensor flange connection	117
				Flange connections	119
				Clamp connections	122
				Welding socket	123
				Couplings	125
5	Electrical connection	36			
	Connection conditions	36			
	Connecting cable connection	37			
	Connecting the transmitter	42			
	Removing a cable	44			
	Ensuring potential equalization	44			
	Hardware settings	46			
	Post-connection check	47			
6	Operation	50			
	Overview of the operating options	50			
	Local operation	50			
	SmartBlue App	55			
7	System integration	58			
	Device description files	58			
	Measured variables via HART protocol	58			

Mounting kit	128
Accessories	129
15 Dimensions in US units	134
Compact version	134
Remote version	135
Sensor flange connection	137
Flange connections	139
Clamp connections	139
Welding socket	140
Mounting kits	141
Accessories	142
16 Accessories	146
Device-specific accessories	146
Communication-specific accessories	147
Service-specific accessory	147
System components	148
17 Appendix	150
Examples for electric terminals	150

Index

1 About this document

Document function	6
Associated documentation	6
Symbols	7
Registered trademarks	9

Document function



These Operating Instructions provide all of the information that is required in various phases of the life cycle of the device:

- Incoming acceptance and product identification
- Storage and transport
- Installation and connection
- Commissioning and operation
- Diagnostics and troubleshooting
- Maintenance and disposal

Associated documentation

Technical Information	Overview of the device with the most important technical data.
Operating Instructions	All the information that is required in the various phases of the life cycle of the device: from product identification, incoming acceptance and storage, to mounting, connection, operation and commissioning through to troubleshooting, maintenance and disposal as well as the technical data and dimensions.
Sensor Brief Operating Instructions	Incoming acceptance, transport, storage and mounting of the device.
Transmitter Brief Operating Instructions	Electrical connection and commissioning of the device.
Description of Parameters	Detailed explanation of the menus and parameters.
Safety Instructions	Documents for the use of the device in hazardous areas.
Special Documentation	Documents with more detailed information on specific topics.
Installation Instructions	Installation of spare parts and accessories.

The related documentation is available online:

W@M Device Viewer	On the www.endress.com/deviceviewer website, enter the serial number of the device: nameplate → <i>Product identification</i> ,  17
Endress+Hauser Operations App	<ul style="list-style-type: none"> ▶ Scan the Data Matrix code: nameplate → <i>Product identification</i>,  17 ▶ Enter the serial number of the device: nameplate → <i>Product identification</i>,  17

Symbols

Warnings

DANGER

This symbol alerts you to an immediate dangerous situation. Failure to avoid the situation will result in a fatal or serious injury.

WARNING

This symbol alerts you to a potentially dangerous situation. Failure to avoid the situation may result in a fatal or serious injury.





CAUTION

This symbol alerts you to a potentially dangerous situation. Failure to avoid the situation may result in a minor or mild injury.





NOTICE

This symbol alerts you to a potentially harmful situation. Failure to avoid the situation may result in damage to the facility or to something in the facility's vicinity.



Electronics

-  Direct current
-  Alternating current
-  Direct current and alternating current
-  Protective earthing









Device communication





-  Bluetooth is enabled.
-  LED is off.
-  LED flashing.
-  LED lit.

Tools



-  Flat blade screwdriver
-  Hexagon wrench
-  Wrench

Types of information

-  Preferred procedures, processes or actions
-  Permitted procedures, processes or actions
-  Forbidden procedures, processes or actions
-  Additional information
-  Reference to documentation
-  Reference to page
-  Reference to graphic
-  Measure or individual action to be observed

-  Series of steps
-  Result of a step
-  Help in the event of a problem
-  Visual inspection
-  Write-protected parameter

Explosion protection

-  Hazardous area
-  Non-hazardous area

Registered trademarks

HART®

Registered trademark of the FieldComm Group, Austin, USA

Bluetooth®

The Bluetooth word mark and Bluetooth logos are registered trademarks of Bluetooth SIG. Inc. and any use of such marks by Endress+Hauser is under license. Other trademarks and trade names are those of their respective owners.

Apple®

Apple, the Apple logo, iPhone, and iPod touch are trademarks of Apple Inc., registered in the U.S. and other countries. App Store is a service mark of Apple Inc.

Android®

Android, Google Play and the Google Play logo are trademarks of Google Inc.

2 Safety instructions

Requirements for specialist personnel	12
Requirements for operating personnel	12
Incoming acceptance and transport	12
Adhesive labels, tags and engravings	12
Environment and process	12
Occupational safety	12
Installation	12
Electrical connection	12
Surface temperature	13
Commissioning	13
Modifications to the device	13

Requirements for specialist personnel

- ▶ Installation, electrical connection, commissioning, diagnostics and maintenance of the device must only be carried out by trained, specialist personnel authorized by the facility's owner-operator.
- ▶ Before commencing work, the trained, specialist personnel must carefully read, understand and adhere to the Operating Instructions, additional documentation and certificates.
- ▶ Comply with national regulations.

Requirements for operating personnel

- ▶ Operating personnel are authorized by the facility's owner-operator and are instructed according to the requirements of the task.
- ▶ Before commencing work, the operating personnel must carefully read, understand and adhere to the instructions provided in the Operating Instructions and additional documentation.

Incoming acceptance and transport

- ▶ Transport the device in a correct and appropriate manner.
- ▶ Do not remove protective covers or protective caps on the process connections.

Adhesive labels, tags and engravings

- ▶ Pay attention to all the safety instructions and symbols on the device.

Environment and process

- ▶ Only use the device for the measurement of appropriate media.
- ▶ Keep within the device-specific pressure range and temperature range.
- ▶ Protect the device from corrosion and the influence of environmental factors.

Occupational safety

- ▶ Wear the required protective equipment according to national regulations.
- ▶ Do not ground the welding unit by means of the device.
- ▶ Wear protective gloves if working on and with the device with wet hands.

Installation

- ▶ Do not remove protective covers or protective caps on the process connections until just before you install the sensor.
- ▶ Do not damage or remove the liner on the flange.
- ▶ Observe tightening torques.

Electrical connection

- ▶ Comply with national installation regulations and guidelines.
- ▶ Observe cable specifications and device specifications.
- ▶ Check the cable for damage.

- ▶ If using the device in hazardous areas, observe the "Safety Instructions" documentation.
- ▶ Provide (establish) potential equalization.
- ▶ Provide (establish) grounding.

Surface temperature

Media with elevated temperatures can cause the surfaces of the device to become hot. For this reason, note the following:

- ▶ Mount suitable touch protection.
- ▶ Wear suitable protective gloves.

Commissioning

- ▶ Operate the device only if it is in proper technical condition, free from errors and faults.
- ▶ Only put the device into operation once you have performed the post-installation check and post-connection check.

Modifications to the device

Modifications or repairs are not permitted and can pose a danger. For this reason, note the following:

- ▶ Only carry out modifications or repairs after consulting beforehand with an Endress+Hauser service organization.
- ▶ Only use original spare parts and original accessories from Endress+Hauser.
- ▶ Install original spare parts and original accessories according to the Installation Instructions.

3 Product information

Measuring principle	16
Designated use	16
Incoming acceptance	16
Product identification	17
Transport	19
Checking the storage conditions	21
Recycling of packaging materials	21
Product design	22
Firmware history	24
Device history and compatibility	24

Measuring principle

Electromagnetic flow measurement on the basis of *Faraday's law of magnetic induction*.

Designated use

The device is only suitable for flow measurement of liquids with a minimum conductivity of 5 $\mu\text{S}/\text{cm}$.

Depending on the version, the device measures potentially explosive, flammable, poisonous and oxidizing media.

Devices for use in a hazardous area, in hygienic applications, or where there is an increased risk due to process pressure, are labeled accordingly on the nameplate.

Non-designated use can compromise safety. The manufacturer is not liable for damage caused by improper or non-designated use.

Incoming acceptance

Is technical documentation provided with the device?	<input type="checkbox"/>
Does the scope of supply match the specifications on the delivery note?	<input type="checkbox"/>
Is the order code on the delivery note and nameplate identical?	<input type="checkbox"/>
Does the device bear any signs of damage from transportation?	<input type="checkbox"/>
Has an incorrect device been ordered or delivered or has the device been damaged in transit? Complaints or returns: www.services.endress.com/return-material	<input type="checkbox"/>

Product identification

Device name

The device comprises the following parts:

- Proline 10 transmitter
- Promag H sensor

Transmitter nameplate

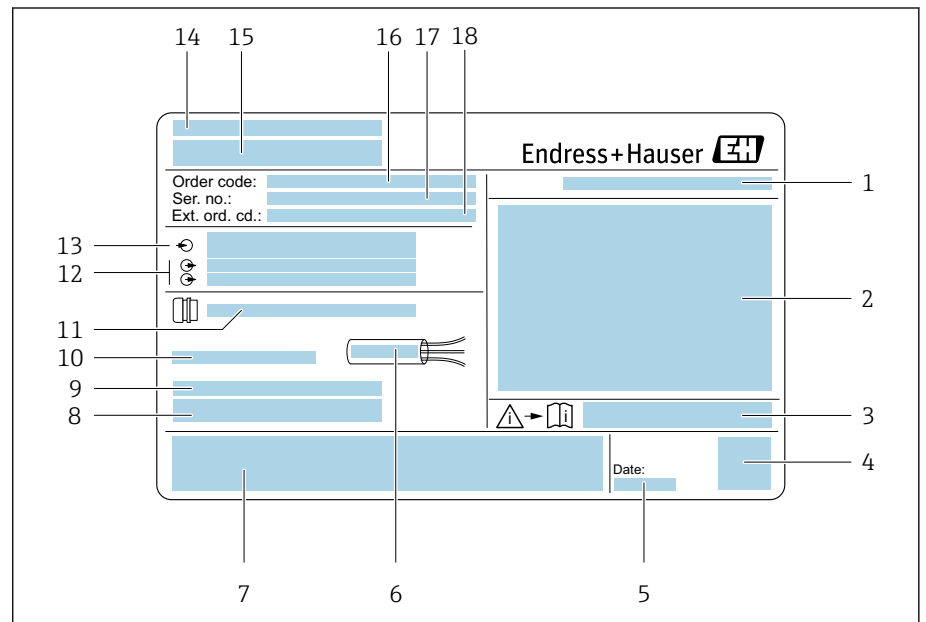

A0042943

1 Example of a transmitter nameplate

- 1 Degree of protection
- 2 Approvals for hazardous area, electrical connection data
- 3 Document number of safety-related supplementary documentation
- 4 Data Matrix code
- 5 Manufacturing date: year-month
- 6 Permitted temperature range for cable
- 7 CE mark and other approval marks
- 8 Firmware version (FW) and device revision (Dev.Rev.) from the factory
- 9 Additional information in the case of special products
- 10 Permitted ambient temperature (T_a)
- 11 Information on the cable entry
- 12 Available inputs and outputs: supply voltage
- 13 Electrical connection data: supply voltage and supply power
- 14 Place of manufacture
- 15 Transmitter name
- 16 Order code
- 17 Serial number
- 18 Extended order code

Sensor nameplate

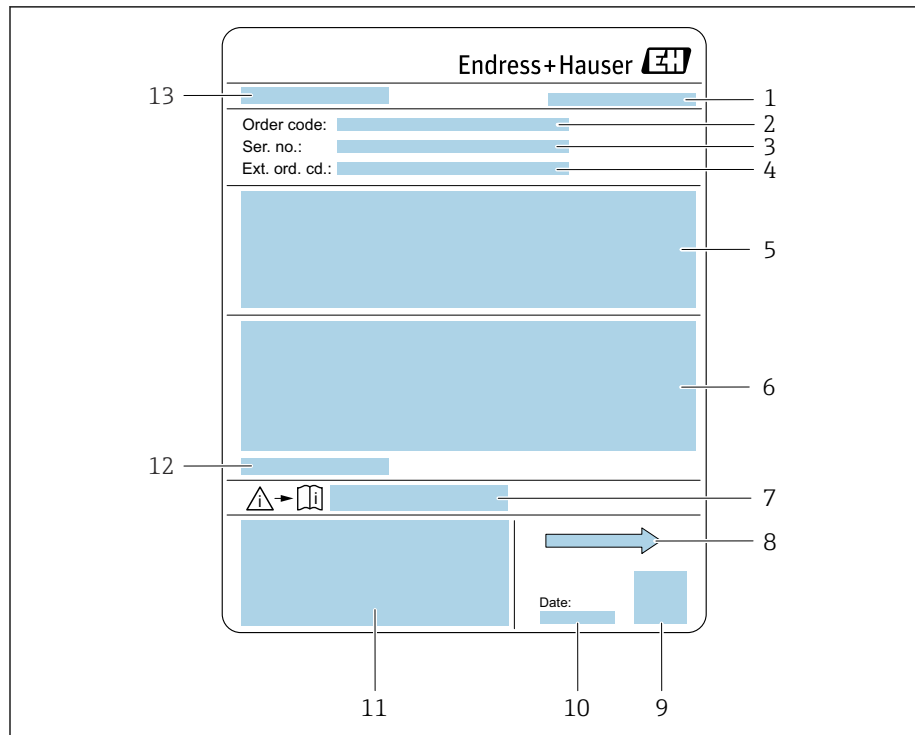

A0043041

2 Example of sensor nameplate

- 1 Place of manufacture
- 2 Order code
- 3 Serial number
- 4 Extended order code
- 5 Approvals, certificates and degree of protection
- 6 Specifications
- 7 Document number of safety-related supplementary documentation
- 8 Flow direction
- 9 Data Matrix code
- 10 Manufacturing date: year-month
- 11 CE mark, C-Tick
- 12 Permitted ambient temperature (T_a)
- 13 Sensor name

Transport

Protective packaging

Protective covers or protective caps are fitted on the process connections to protect against damage and dirt.

Transporting in the original packaging

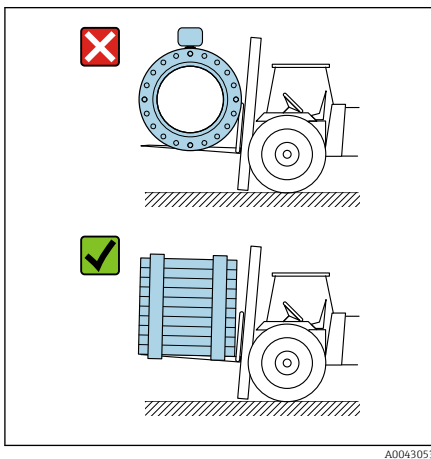

A0043053

NOTICE

Original packaging is missing!

Damage to the magnetic coil.

- ▶ Only lift and transport the device in the original packaging.

Transporting with lifting lugs

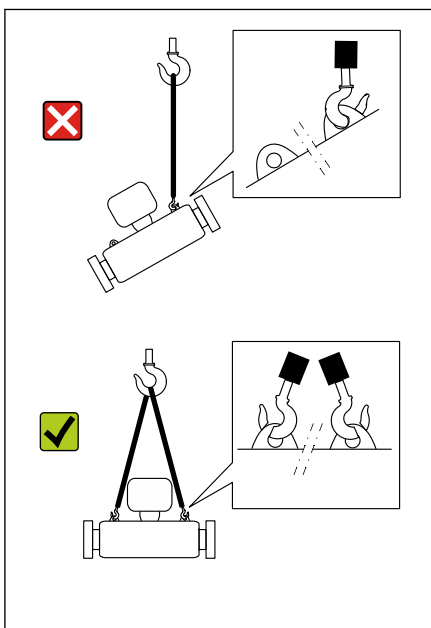

A0043058

⚠ DANGER

Potentially life-threatening hazard from suspended loads!

The device could fall.

- ▶ Secure the device against slipping and turning.
- ▶ Do not move suspended loads over people.
- ▶ Do not move suspended loads over unprotected areas.

NOTICE

Lifting equipment incorrectly attached!

Lifting equipment attached on one side only can damage the device.

- ▶ Attach lifting equipment to both lifting lugs.

Transporting without lifting lugs

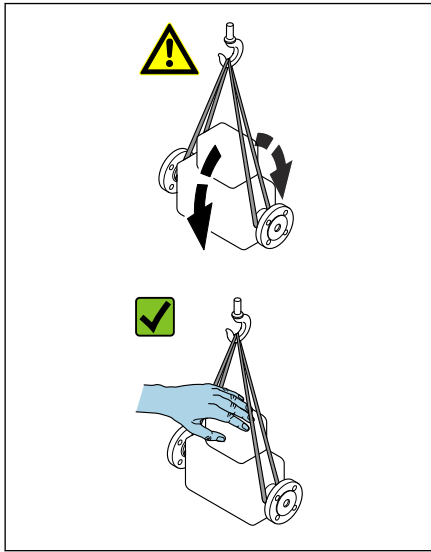

A0043054

⚠ DANGER

Potentially life-threatening hazard from suspended loads!

The device could fall.

- ▶ Secure the device against slipping and turning.
- ▶ Do not move suspended loads over people.
- ▶ Do not move suspended loads over unprotected areas.

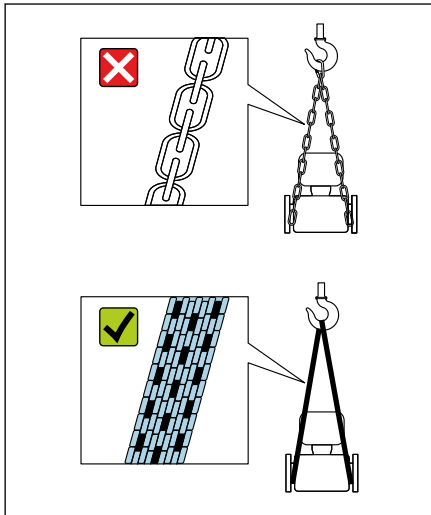

A0043055

NOTICE

Incorrect lifting equipment can damage the device!

The use of chains as hoists can damage the device.

- ▶ Use textile hoists.

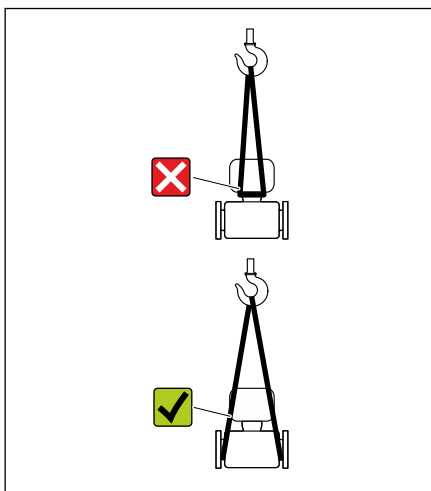

A0043056

NOTICE

Lifting equipment incorrectly attached!

Lifting equipment attached to unsuitable points can damage the device.

- ▶ Attach lifting equipment to both process connections of the device.

Checking the storage conditions

Are the protective covers or protection caps on the process connections?	<input type="checkbox"/>
Is the device in the original packaging?	<input type="checkbox"/>
Is the device protected against sunlight?	<input type="checkbox"/>
Is it guaranteed that the device is not stored outdoors?	<input type="checkbox"/>
Is the device stored in a dry and dust-free place?	<input type="checkbox"/>
Does the storage temperature match the device ambient temperature specified on the nameplate?	<input type="checkbox"/>
Is the possibility of moisture/condensation collecting on the device and original packaging as a result of variations in temperature ruled out?	<input type="checkbox"/>

Recycling of packaging materials

All packaging materials and packaging aids must be recycled as specified by national regulations.

- Stretch wrap: polymer in accordance with EU Directive 2002/95/EC (RoHS)
- Crate: wood in accordance with ISPM 15 standard, confirmed by IPPC logo
- Cardboard box: in accordance with European Packaging Directive 94/62/EC, confirmed by Resy symbol
- Disposable pallet: plastic or wood
- Packaging straps: plastic
- Adhesive strips: plastic
- Padding: paper

Product design

Compact version

The transmitter and sensor form a mechanical unit.

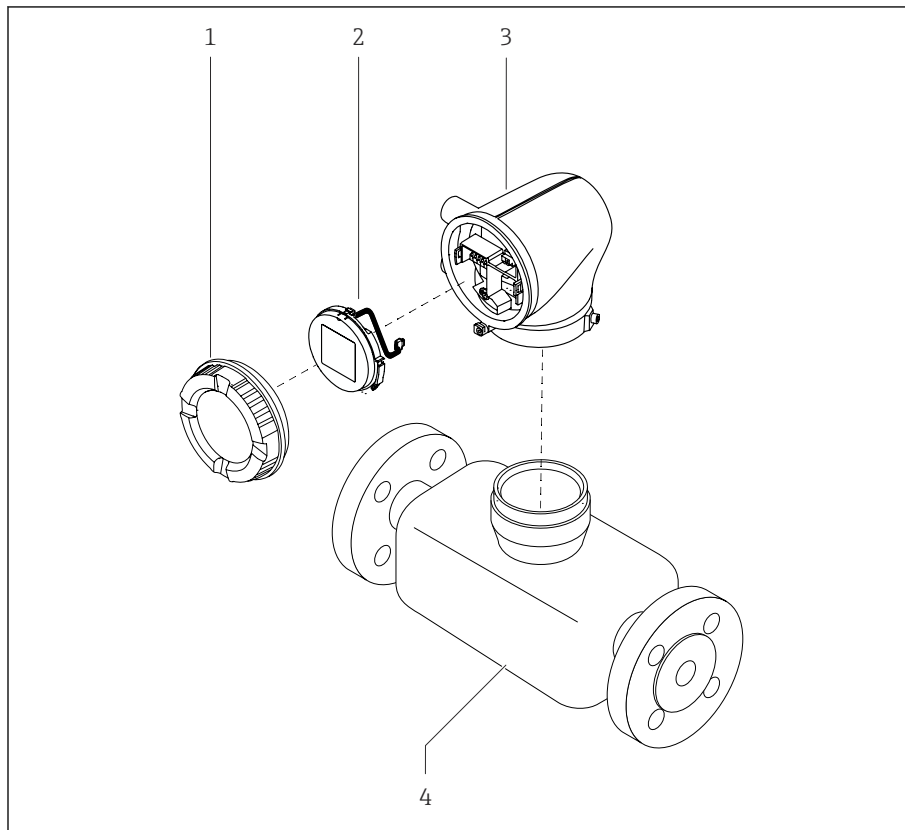

A0043525

3 Main device components

- 1 Housing cover
- 2 Display module
- 3 Transmitter housing
- 4 Sensor

Remote version

The transmitter and sensor are installed in physically separate locations.

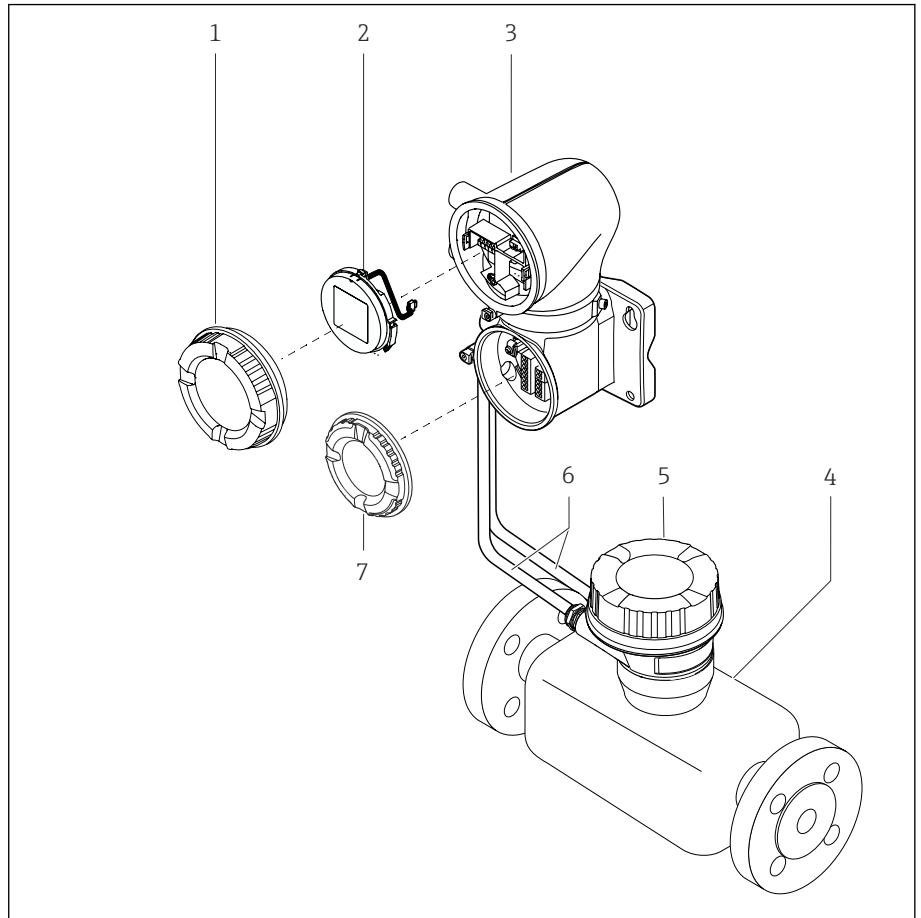

A0043524

4 Main device components

- 1 Housing cover
- 2 Display module
- 3 Transmitter housing
- 4 Sensor
- 5 Sensor connection housing
- 6 Connecting cable consisting of coil current cable and electrode cable
- 7 Connection compartment cover

Firmware history

List of firmware versions and changes since previous version

Firmware version 01.00.zz

Release date	2021-07-01	Original firmware
Version of the Operating Instructions	01.21	
Order code for "Firmware version"	Option 78	

Device history and compatibility

List of device models and changes since previous model

Device model A1

Release	2021-07-01	-
Version of the Operating Instructions	01.21	
Compatibility with previous model	-	

4 Installation

Installation conditions	26
Installing the device	30
Post-installation check	34

Installation conditions

Flow direction

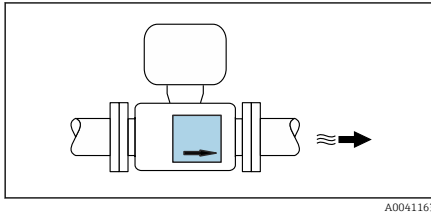

Install the device in the direction of flow.

i Note the direction of arrow on the nameplate.

Inlet runs and outlet runs

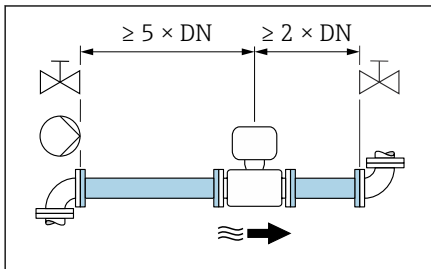

Ensure straight, undisturbed inlet and outlet runs.

i To avoid negative pressure and to comply with accuracy specifications, install the sensor upstream from assemblies that produce turbulence (e.g. valves, T-sections) and downstream from pumps → *Installation near pumps*, 28.

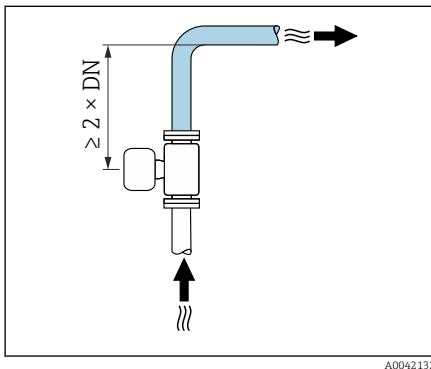

Keep a sufficient distance to the next pipe elbow.

Orientations

Vertical orientation, upward direction of flow

For all applications.

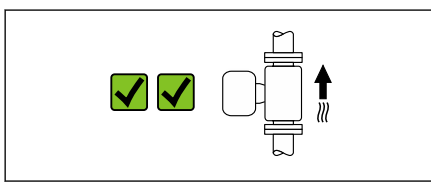

Horizontal orientation, transmitter at top

This orientation is suitable for the following applications:

- For low process temperatures in order to maintain the minimum ambient temperature for the transmitter.
- For empty pipe detection, even in the case of empty or partially filled measuring pipes.

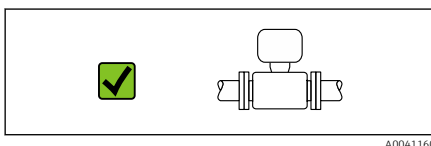

Mounting locations

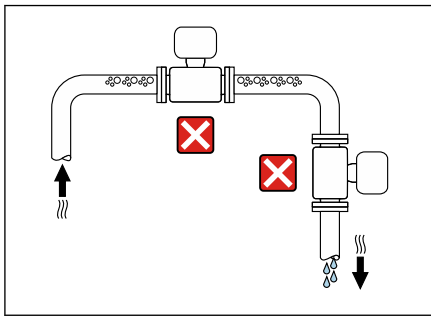

A0042131

- Do not install the device at the highest point of the pipe.
- Do not install the device upstream from a free pipe outlet in a down pipe.

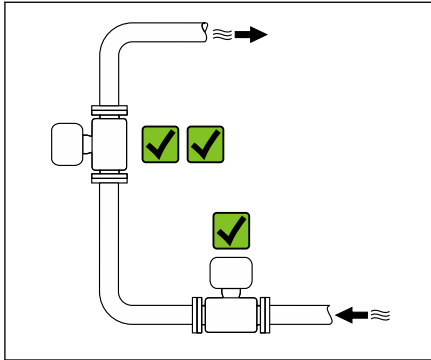

A0042317

Installation near control valves

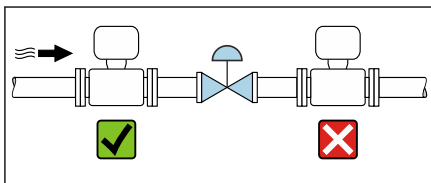

A0041091

Install the device in the direction of flow upstream from the control valve.

Installation upstream from a down pipe

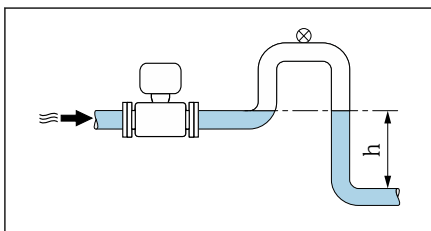

A0041089

NOTICE

Negative pressure in the measuring pipe can damage the liner!

- ▶ If installing upstream from down pipes with a length $h \geq 5 \text{ m}$ (16.4 ft): install a siphon with a vent valve downstream from the device.

i This arrangement prevents the flow of liquid stopping in the pipe and air entrainment.

Installation with partially filled pipes

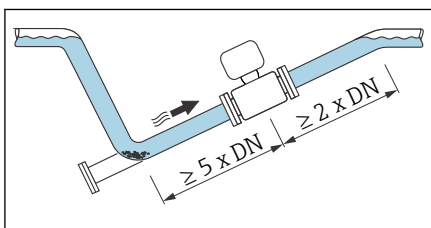

A0041088

- Partially filled pipes with a gradient require a drain-type configuration.
- The installation of a cleaning valve is recommended.

Installation near pumps

NOTICE

Negative pressure in the measuring pipe can damage the liner!

- ▶ Install the device in the direction of flow downstream from the pump.
- ▶ Install pulsation dampers if reciprocating, diaphragm or peristaltic pumps are used.

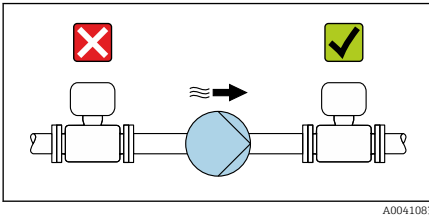

Pipe vibrations

A remote version is recommended in the event of strong pipe vibrations.

NOTICE

Pipe vibrations can damage the device!

- ▶ Do not expose the device to strong vibrations.
- ▶ Support the pipe and fix it in place.
- ▶ Support the device and fix it in place.
- ▶ Mount the sensor and transmitter separately.

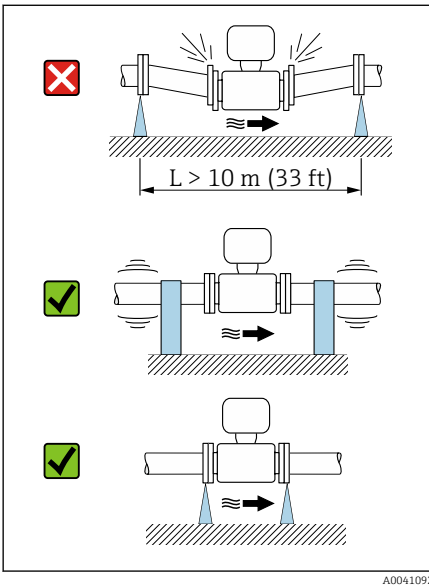

Adapters

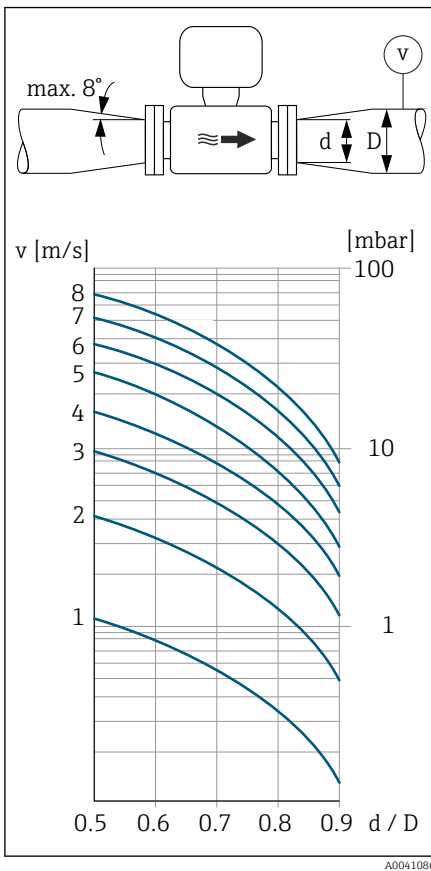

Suitable adapters (double-flange reducers) can be used to install the sensor in larger-diameter pipes. The resulting higher rate of flow improves measuring accuracy with very slow-moving media.

i The nomogram shown here can be used to calculate the pressure loss caused by reducers and expanders. It only applies to liquids with a viscosity similar to that of water.

1. Calculate the ratio of the diameters d/D .
2. Determine the flow velocity after the reduction.
3. From the chart, determine the pressure loss as a function of the flow velocity v and the d/D ratio.

Seals

Note the following when installing seals:
For plastic flanges: seals are **always** required.

Magnetism and static electricity

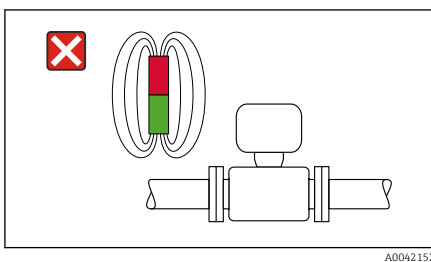

Do not install the device near magnetic fields, e.g. motors, pumps, transformers.

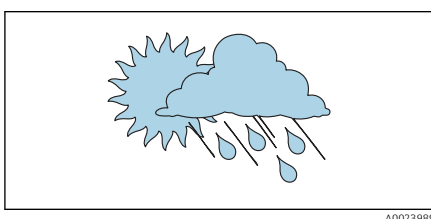

Outdoor use

- Avoid exposure to direct sunlight.
- Install in a location protected from sunlight.
- Avoid direct exposure to weather conditions.
- Use a weather protection cover → *Transmitter*, 146.

Installing the device

Preparing the device

1. Remove the entire transportation packaging.
2. Remove protective covers or protective caps on the device.

Installing seals

⚠ WARNING

Improper process sealing can put staff at risk!

- ▶ Check whether the seals are clean and undamaged.

NOTICE

Incorrect installation can lead to incorrect measurement results!

- ▶ The internal diameter of the seal must be greater than or equal to that of the process connection and pipe.
- ▶ Fit the seals and measuring pipe centrally.
- ▶ Make sure that the seals do not protrude into the pipe cross-section.

In the case of metal process connections, tighten the screws. The process connection forms a metal connection with the sensor, which ensures a defined compression of the seal.

Installing the grounding rings

- In the case of plastic pipes or pipes with an insulating liner, grounding is via grounding rings.
- Observe the information for the use of grounding rings → *Ensuring potential equalization*, 44.
- Grounding rings can be ordered separately from Endress+Hauser → *Device-specific accessories*, 146.

Installing the sensor

1. Install the sensor between the pipe flanges.
2. In the case of plastic process connections, observe the maximum screw tightening torque for lubricated threads: 7 Nm (5.2 lbf ft).
3. Install the device or turn the transmitter housing in such a way that the cable entries point down or to the side.

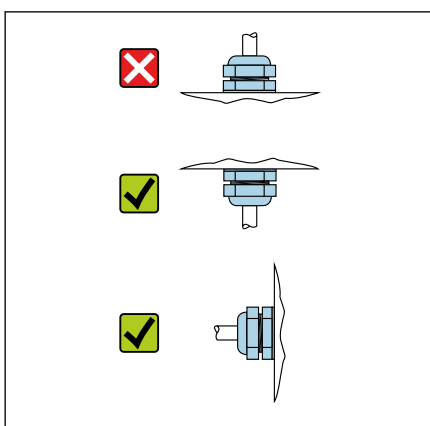

A0044192

Welding in the sensor

⚠ WARNING

Incorrect grounding of the welding device damages the electronics!

- ▶ Do not ground the welding unit by means of the device.

1. Tack-weld the sensor to secure it in the pipe. A suitable welding aid can be ordered separately as an accessory → *Sensor*, ☰ 146.
2. Loosen the hexagonal-headed bolts.
3. Open the pipe at least 8 mm (0.31 in) to remove the sensor and seal.
4. Remove the process connection from the sensor, along with the seal, from the pipe.
5. If thin-walled pipes carrying food are welded correctly:
Remove the sensor and seal.
6. Weld the process connection into the pipe.

⚠ WARNING

Improper process sealing can put staff at risk!

- ▶ Check whether the seals are clean and undamaged.
- ▶ Install the sensor between the two pipe flanges.

Mounting the transmitter on the wall

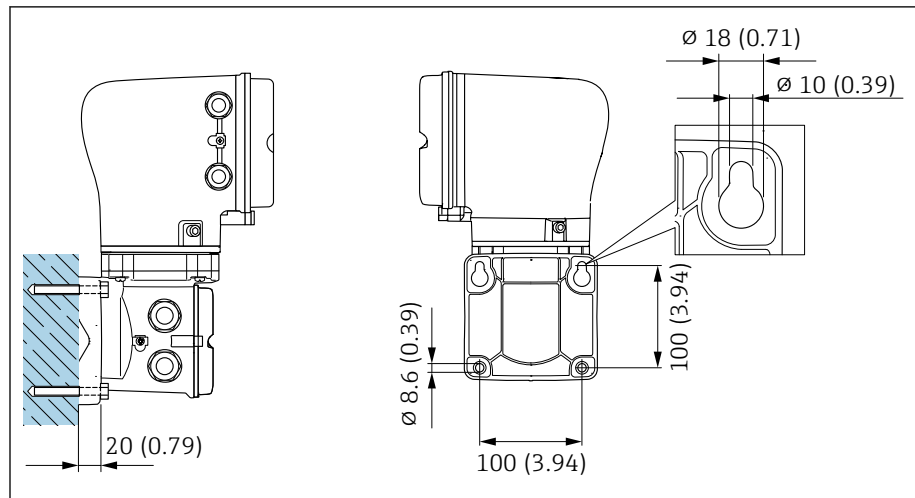

5 Engineering unit mm (in)

NOTICE

Ambient temperature too high!

If the electronics overheat this can damage the transmitter housing.

- ▶ Do not exceed the permissible temperature range for the ambient temperature.
- ▶ Use a weather protection cover → *Transmitter*, 146.
- ▶ Mount the device correctly.

Mounting the transmitter on a post

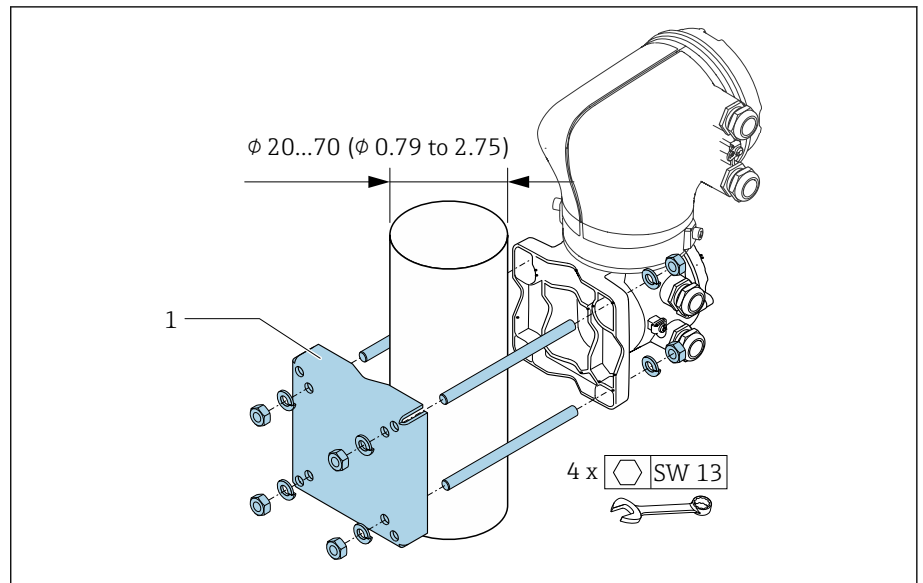

A0043471

6 Engineering unit mm (in)

NOTICE

Ambient temperature too high!

If the electronics overheat this can damage the transmitter housing.

- ▶ Do not exceed the permissible temperature range for the ambient temperature.
- ▶ Use a weather protection cover → *Transmitter*, 146.
- ▶ Mount the device correctly.

Turning the transmitter housing

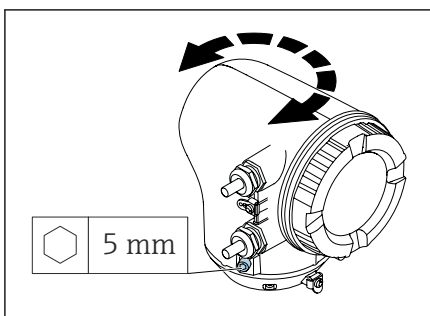

A0041095

1. Loosen the fixing screws on both sides of the transmitter housing.

2. NOTICE

Overrotation of the transmitter housing!

Interior cables are damaged.

- ▶ Turn the transmitter housing a maximum of 180° in each direction.

Turn the transmitter housing to the desired position.

3. Tighten the screws in the logically reverse sequence.

Post-installation check

Is the device undamaged (visual inspection)?	<input type="checkbox"/>
Does the device comply with the measuring point specifications? For example: <ul style="list-style-type: none">■ Process temperature■ Process pressure■ Ambient temperature■ Measuring range	<input type="checkbox"/>
Has the correct orientation been selected for the device?	<input type="checkbox"/>
Does the direction of the arrow on the device match the flow direction of the medium?	<input type="checkbox"/>
Is the device protected against precipitation and sunlight?	<input type="checkbox"/>
Are the screws tightened with the correct tightening torque?	<input type="checkbox"/>

5 Electrical connection

Connection conditions	36
Connecting cable connection	37
Connecting the transmitter	42
Removing a cable	44
Ensuring potential equalization	44
Hardware settings	46
Post-connection check	47

Connection conditions

Notes on the electrical connection

WARNING

Components carry voltage!

Incorrect work performed on the electrical connections can result in an electric shock.

- ▶ Have electrical connection work carried out by appropriately trained specialists only.
- ▶ Comply with applicable federal/national installation codes and regulations.
- ▶ Comply with national and local workplace safety regulations.
- ▶ Establish the connections in the correct order: always make sure to first connect the protective earth (PE) to the inner ground terminal.
- ▶ When using in hazardous areas, observe the "Safety Instructions" document.
- ▶ Ground the device carefully and provide potential equalization.
- ▶ Connect protective earthing to all outer ground terminals.

Additional protective measures

The following protective measures are required:

- Set up a disconnecting device (switch or power-circuit breaker) to easily disconnect the device from the supply voltage.
- In addition to the device fuse, include an overcurrent protection unit, with max. 10 A, in the facility installation.
- Plastic sealing plugs act as safeguards during transportation and must be replaced by suitable, individually approved installation material.
- Connection examples: → *Examples for electric terminals*,  150

Connecting cable connection

Preparing the connecting cable

Coil current cable

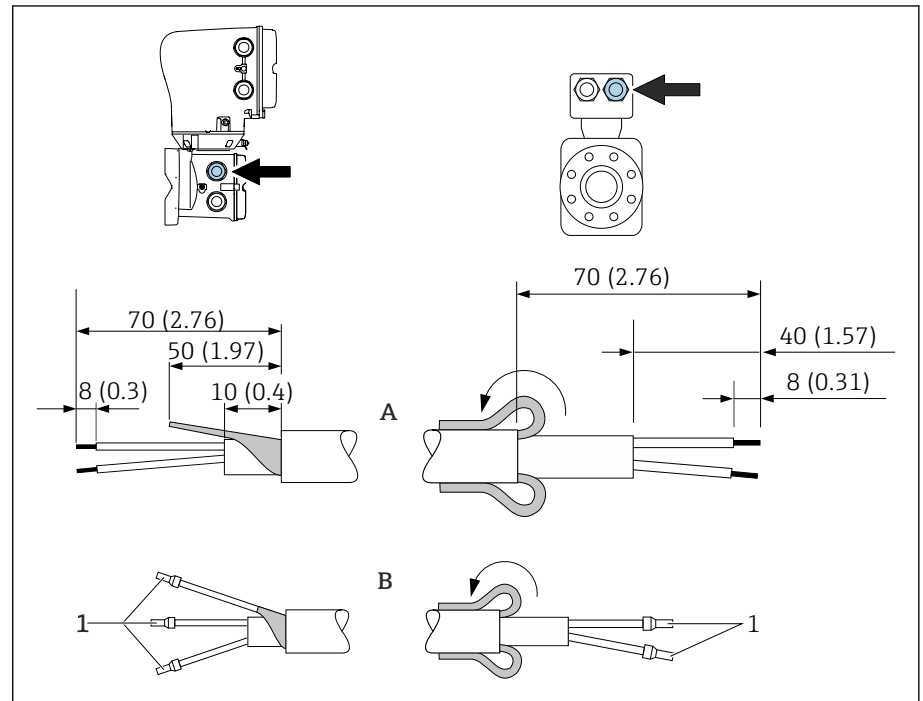

A0044201

1 Ferrules, red $\phi 1.0$ mm (0.04 in)

1. Insulate one core of the three-core cable at the level of the core reinforcement. Only 2 cores are required for the connection.
2. A: Terminate the coil current cable.
3. B: Fit ferrules over the strands and press in place.
4. Fit the cable shield on the sensor side over the outer jacket.
5. Insulate the cable shield on the transmitter side, e.g. heat shrink tube.

Electrode cable

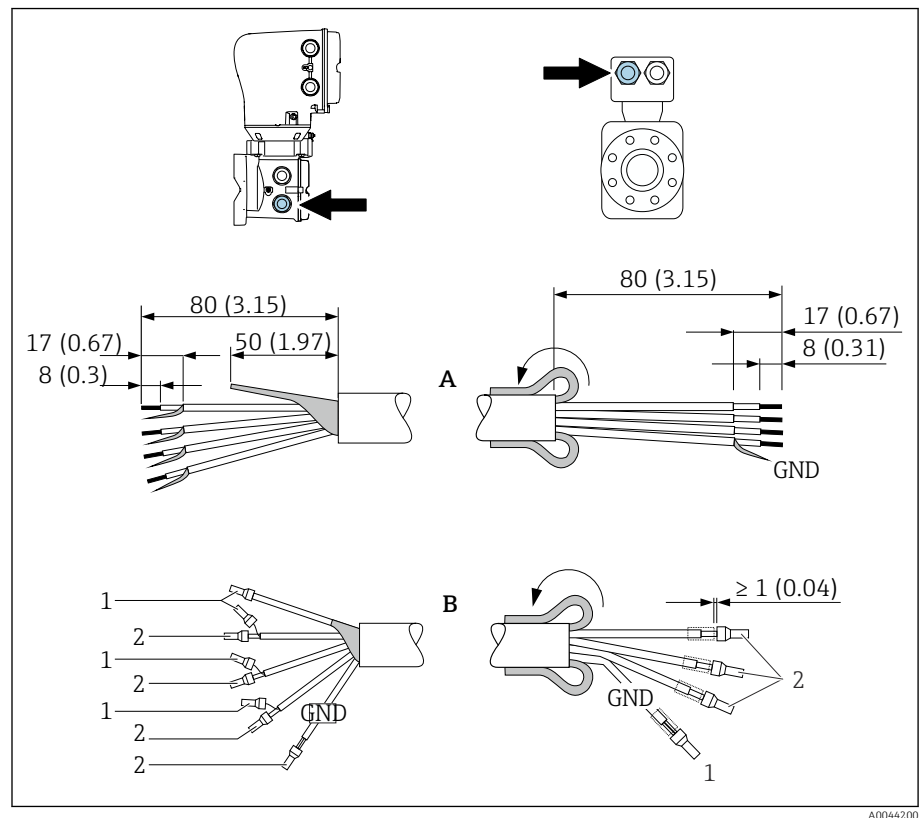

A0044200

1. Make sure that the ferrules do not touch the cable shields on the sensor side. Minimum distance = 1 mm (exception: green "GND" cable)
2. A: Terminate the electrode cable.
3. B: Fit ferrules over the strands and press in place.
4. Fit the cable shield on the sensor side over the outer jacket.
5. Insulate the cable shield on the transmitter side, e.g. heat shrink tube.

Attaching the connecting cable

Connecting cable terminal assignment

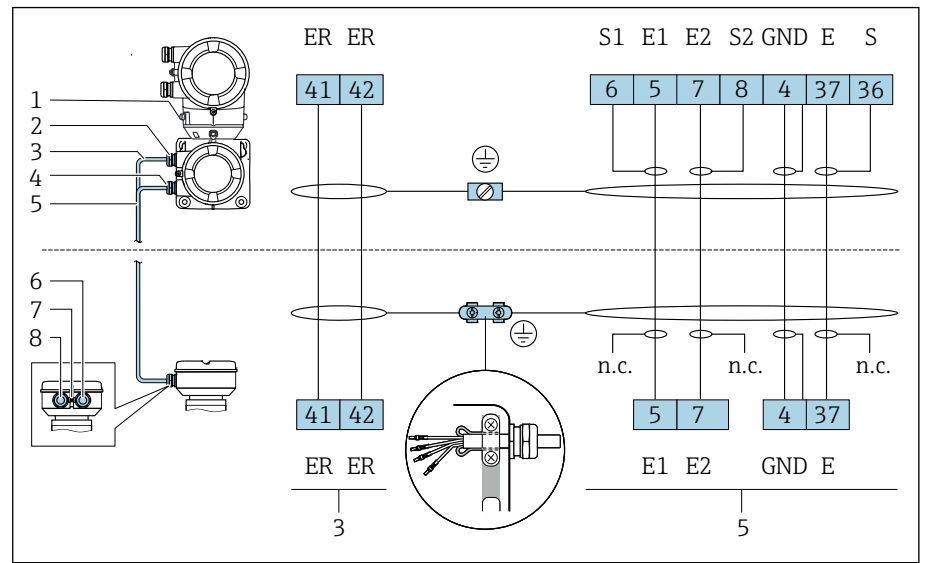

A0044619

- 1 Ground terminal, outer
- 2 Transmitter housing: cable entry for coil current cable
- 3 Coil current cable
- 4 Transmitter housing: cable entry for electrode cable
- 5 Electrode cable
- 6 Sensor connection housing: cable entry for electrode cable
- 7 Ground terminal, outer
- 8 Sensor connection housing: cable entry for coil current cable

Wiring the sensor connection housing

NOTICE

Incorrect wiring can damage the electronic components!

- ▶ Only connect sensors and transmitters with identical serial numbers.
- ▶ Connect the sensor connection housing and the transmitter housing to the potential equalization of the facility via the outer ground terminal.
- ▶ Connect the sensor and transmitter to the same potential.

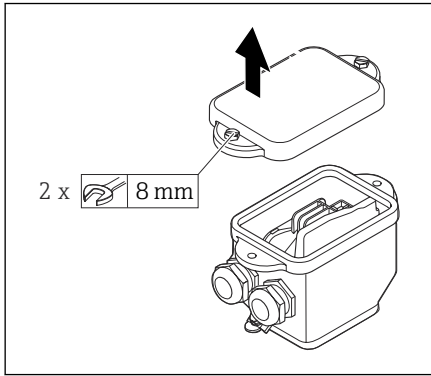

A0044737

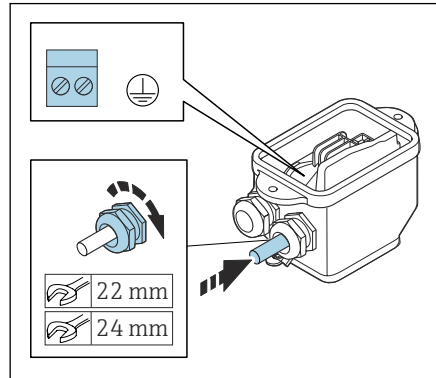

A0044738

1. Loosen the hexagonal-headed bolt of the connection compartment cover.
2. Remove the connection compartment cover.

NOTICE**If the sealing ring is missing, the housing is not sealed tight!**

Damage to the device.

- ▶ Do not remove the sealing ring from the cable entry.

3. Feed the coil current cable and electrode cable through the corresponding cable entry.
4. Adjust the cable lengths.
5. Connect the cable shield to the strain relief clamp.
6. Strip the cable and cable ends.
7. Fit ferrules over the strands and press in place.
8. Connect the coil current cable and the electrode cable as per the terminal assignment.
9. Tighten the cable glands.
10. Screw on the connection compartment cover.

Wiring the transmitter housing**NOTICE****Incorrect wiring can damage the electronic components!**

- ▶ Only connect sensors and transmitters with identical serial numbers.
- ▶ Connect the sensor connection housing and the transmitter housing to the potential equalization of the facility via the outer ground terminal.
- ▶ Connect the sensor and transmitter to the same potential.

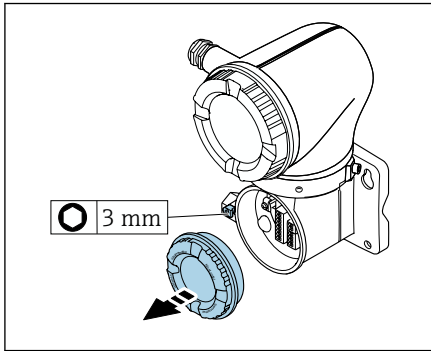

1. Loosen the Allen key of the securing clamp.
2. Unscrew the connection compartment cover in the counterclockwise direction.

NOTICE

If the sealing ring is missing, the housing is not sealed tight!

Damage to the device.

- ▶ Do not remove the sealing ring from the cable entry.

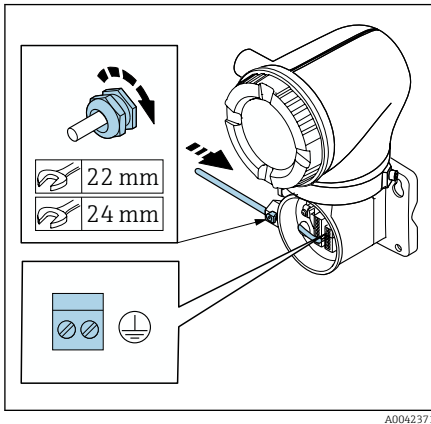

3. Feed the coil current cable and electrode cable through the corresponding cable entry.
4. Adjust the cable lengths.
5. Connect the cable shields to the inner ground terminal.
6. Strip the cable and cable ends.
7. Fit ferrules over the strands and press in place.
8. Connect the coil current cable and the electrode cable as per the terminal assignment.
9. Tighten the cable glands.
10. Screw on the connection compartment cover.
11. Fasten the securing clamp.

Connecting the transmitter

Transmitter terminal connections

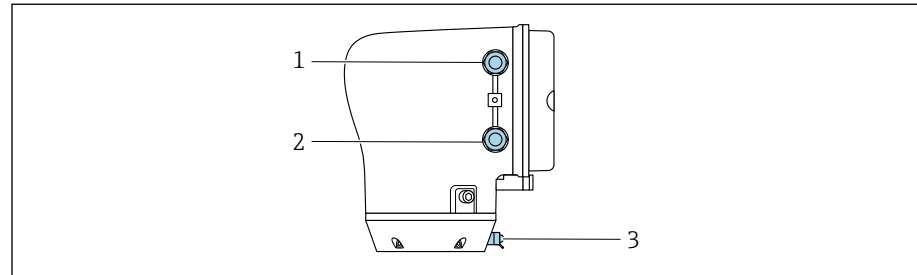

- 1 Cable entry for power supply cable: supply voltage
 2 Cable entry for signal cable
 3 Ground terminal, outer

A0045438

Terminal assignment

i The terminal assignment is documented on an adhesive label.

The following terminal assignment is available:

Current output 4 to 20 mA HART (active) and pulse/frequency/switch output

Supply voltage		Output 1				Output 2	
1 (+)	2 (-)	26 (+)	27 (-)	24 (+)	25 (-)	22 (+)	23 (-)
L/+	N/-	Current output 4 to 20 mA HART (active)		-		Pulse/frequency/switch output (passive)	

Current output 4 to 20 mA HART (passive) and pulse/frequency/switch output

Supply voltage		Output 1				Output 2	
1 (+)	2 (-)	26 (+)	27 (-)	24 (+)	25 (-)	22 (+)	23 (-)
L/+	N/-	-		Current output 4 to 20 mA HART (passive)		Pulse/frequency/switch output (passive)	

Wiring the transmitter

- i**
- Use a suitable cable gland for the power supply cable and signal cable.
 - Pay attention to the requirements for the power supply cable and signal cable → *Requirements for connecting cable*, 96 .
 - Use shielded cables for digital communication.

NOTICE

If the cable gland is incorrect, this compromises the sealing of the housing!
 Damage to the device.

- Use a suitable cable gland corresponding to the degree of protection.

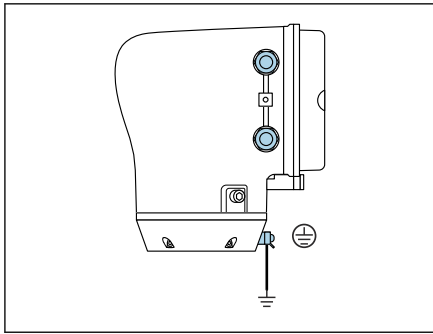

1. Ground the device carefully and provide potential equalization.
2. Connect protective earthing to the outer ground terminals.

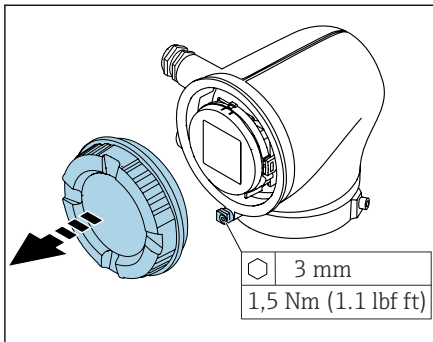

3. Loosen the Allen key of the securing clamp.
4. Unscrew the housing cover in the counterclockwise direction.

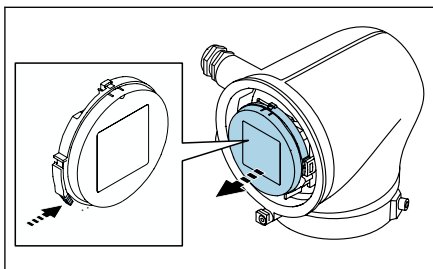

5. Press the tab of the display module holder.
6. Remove the display module from the display module holder.

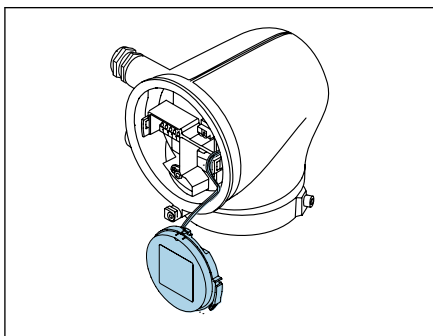

-  The cable must be in the tab for strain relief.
- 7. Let the display module hang down.

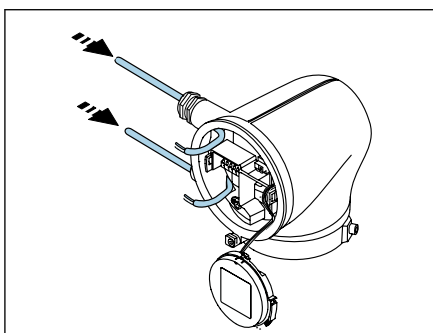

8. Remove dummy plug if present.

NOTICE

If the sealing ring is missing, the housing is not sealed tight!
Damage to the device.

- ▶ Do not remove the sealing ring from the cable entry.

9. Feed the power supply cable and signal cable through the corresponding cable entry.

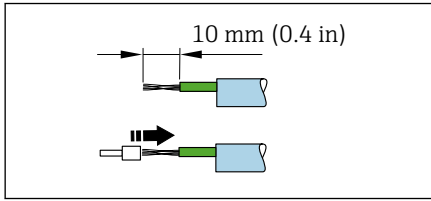

A0041357

10. Strip the cable and cable ends.
11. Fit ferrules over the strands and press in place.

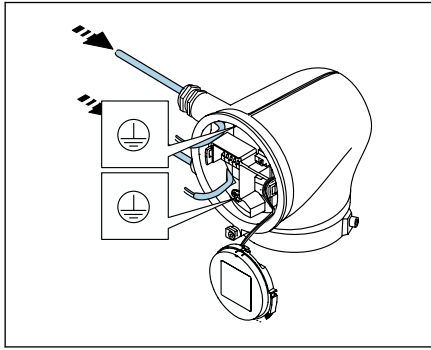

A0041358

- i** The terminal assignment is documented on an adhesive label.
12. Connect the protective ground (PE) to the inner ground terminal.
 13. Connect the power supply cable and signal cable as per the terminal assignment.
 14. Connect the cable shields to the inner ground terminal.
 15. Tighten the cable glands.
 16. Follow the sequence in the reverse order to reassemble.

Removing a cable

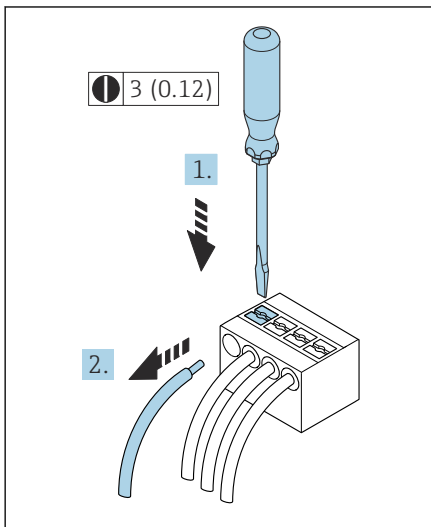

A0029598

1. Use a flat-blade screwdriver to press down on the slot between the two terminal holes and hold.
2. Remove the cable end from the terminal.

7 Engineering unit mm (in)

Ensuring potential equalization

Metal process connections

Potential equalization is via the metal process connections that are in contact with the medium and mounted directly on the sensor.

Plastic process connections

Note the following when using grounding rings:

- Depending on the option ordered, plastic disks are used instead of grounding rings on some process connections. The plastic disks act as "spacers" and do not have any potential equalization function. They perform a significant sealing function at the sensor and process connection interfaces. In the case of process connections without metal grounding rings, the plastic disks and seals must never be removed. Plastic disks and seals must always be installed.
- Grounding rings can be ordered separately as an accessory from Endress+Hauser. The grounding rings must be compatible with the electrode material, as otherwise there is the danger that the electrodes could be destroyed by electrochemical corrosion.
- Grounding rings, including seals, are installed inside the process connections. This does not affect the installation length.

Connection example for potential equalization with additional grounding ring

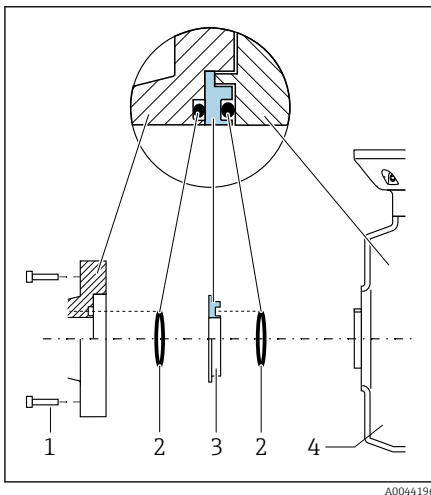

NOTICE

If potential equalization is not provided, this can lead to the electrochemical degradation of the electrodes or affect measuring accuracy!
Damage to the device.

- ▶ Install grounding rings.
- ▶ Provide (establish) potential equalization.

1. Loosen the hexagonal-headed bolts (1).
2. Remove the process connection from the sensor (4).
3. Remove the plastic disk (3), along with the seals (2), from the process connection.
4. Place the first seal (2) into the groove of the process connection.
5. Place the metal grounding ring (3) into the process connection.
6. Place the second seal (2) into the groove of the grounding ring.
7. Observe the maximum screw tightening torques for lubricated threads: 7 Nm (5.2 lbf ft)
8. Mount the process connection on the sensor (4).

Connection example for potential equalization with grounding electrodes

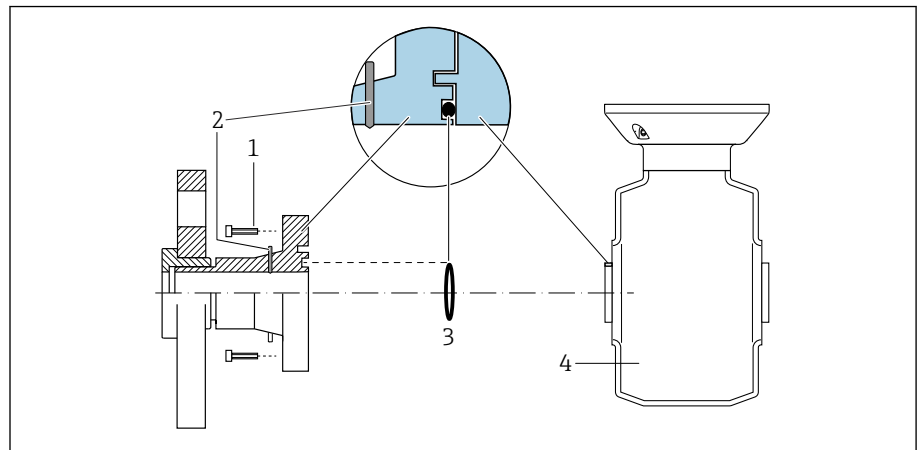

A0028972

- 1 Hexagonal-headed bolts of process connection
- 2 Integrated grounding electrodes
- 3 Seal
- 4 Sensor

Hardware settings

Enabling write protection

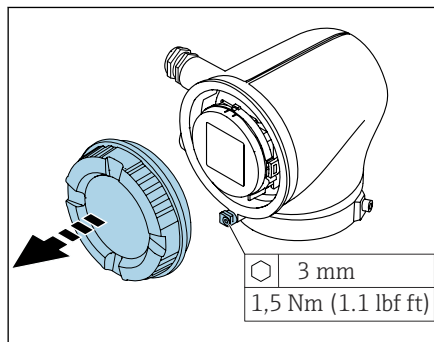

A0041094

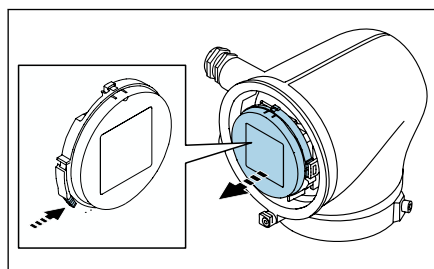

A0041330

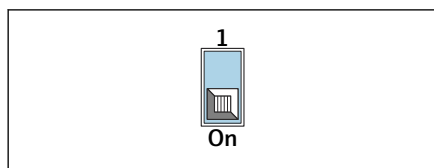

A0044412

1. Loosen the Allen key of the securing clamp.
2. Unscrew the housing cover in the counterclockwise direction.
3. Press the tab of the display module holder.
4. Remove the display module from the display module holder.
5. Set the write protection switch on the back of the display module to the **On** position.
 - ↳ Write protection is enabled.
6. Follow the sequence in the reverse order to reassemble.

Post-connection check

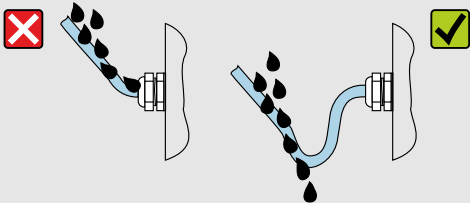
Only for remote version: Is the serial number on the nameplates of the connected sensor and transmitter identical?	<input type="checkbox"/>
Is the potential equalization established correctly?	<input type="checkbox"/>
Is the protective earthing established correctly?	<input type="checkbox"/>
Are the device and cable undamaged (visual check)?	<input type="checkbox"/>
Do the cables meet the requirements?	<input type="checkbox"/>
Is the terminal assignment correct?	<input type="checkbox"/>
Have old and damaged seals been replaced?	<input type="checkbox"/>
Are the seals dry, clean and installed correctly?	<input type="checkbox"/>
Are all the cable glands installed, firmly tightened and leak-tight?	<input type="checkbox"/>
Are dummy plugs inserted in unused cable entries?	<input type="checkbox"/>
Are transportation plugs replaced by dummy plugs?	<input type="checkbox"/>
Are the housing screws and housing cover tightened?	<input type="checkbox"/>
Do the cables loop down before the cable gland ("water trap")? 	<input type="checkbox"/>
Does the supply voltage match the specifications on the transmitter nameplate?	<input type="checkbox"/>

A0042316

6 Operation

Overview of the operating options	50
Local operation	50
SmartBlue App	55

Overview of the operating options

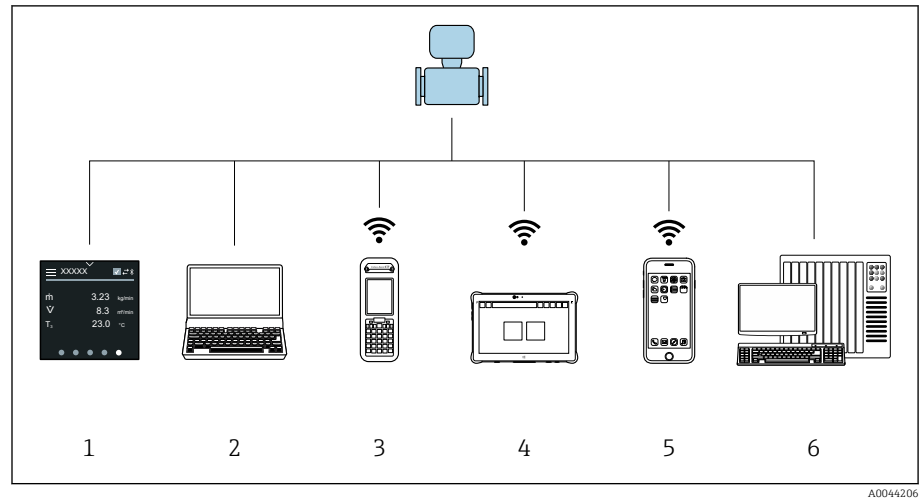

- 1 Local operation via touch screen
- 2 Computer with operating tool, e.g. FieldCare, DeviceCare, AMS Device Manager, SIMATIC PDM
- 3 Field Xpert SFX350 or SFX370 via Bluetooth, e.g. SmartBlue App
- 4 Field Xpert SMT70 via Bluetooth, e.g. SmartBlue App
- 5 Tablet or smartphone via Bluetooth, e.g. SmartBlue App
- 6 Automation system, e.g. PLC

Local operation

Unlocking local operation

Local operation must first be unlocked before the device can be operated via the touch screen. To unlock, draw the pattern "L" on the touch screen.

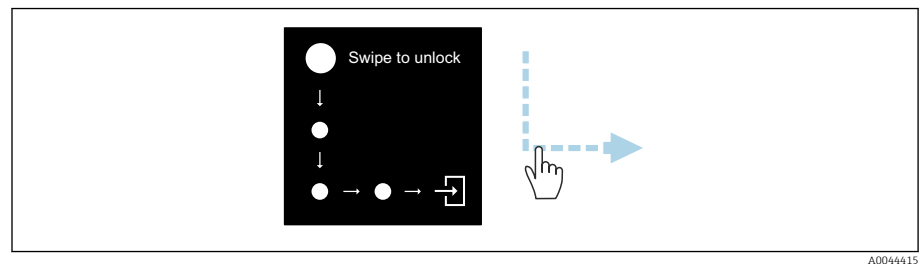

Navigation

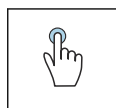

Tap

- Open menus.
- Select items in a list.
- Acknowledge buttons.
- Enter characters.

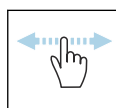

Swipe horizontally

Display next or previous page.

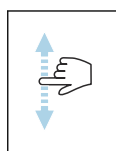

Swipe vertically

Display additional points in a list.

Operational display

During routine operation, the local display shows the operational display screen. The operational display consists of several windows which the user can toggle between.

i The operational display can be customized: see the description of parameters → *Main menu*, 52.

Operational display and navigation

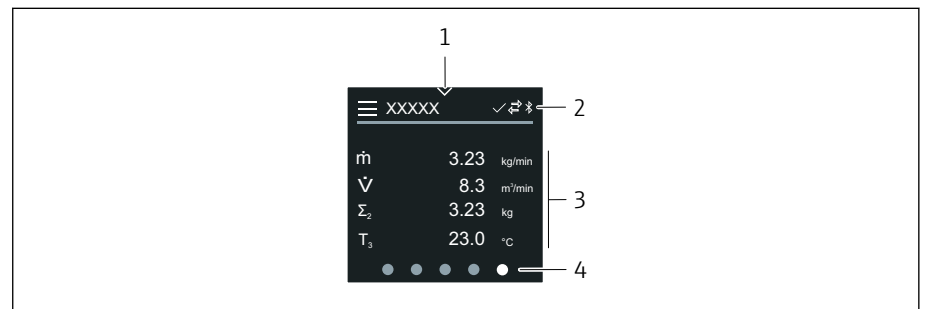

A0042992

- 1 Quick access
- 2 Status symbols, communication symbols and diagnostic symbols
- 3 Measured values
- 4 Rotating page display

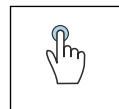

Tap

- Open the main menu.
- Open quick access.

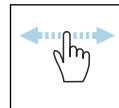

Swipe horizontally

Display next or previous page.

Symbols

- ☰ Open the main menu.
- ✓ Quick access
- 🔒 Locking status
- 📶 Bluetooth is active.
- ↔ Device communication is enabled.
- ▽ Status signal: function check
- ⬢ Status signal: maintenance required
- ⚠ Status signal: out of specification
- ⊗ Status signal: failure
- ☑ Status signal: diagnostics active.

Quick access

The Quick access menu contains a selection of specific device functions.

i Quick access is indicated by a triangle at the top of the local display in the middle.

Quick access and navigation

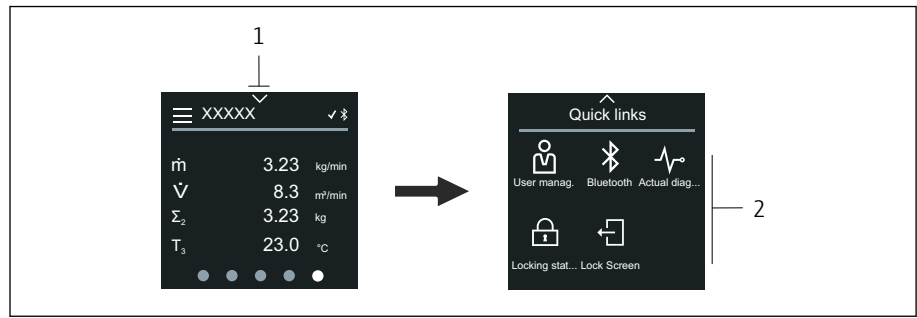

A0044208

- 1 Quick access
- 2 Quick access with specific device functions

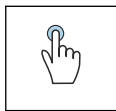

Tap

- Back to operational display.
- Open specific device functions.

Symbols

When a symbol is tapped, the local display shows the menu with the corresponding specific device functions.

- ⌘ Enable or disable Bluetooth.
- 🔑 Enter access code.
- 🔒 Write protection is enabled.
- ✕ Back to operational display.

Main menu

The main menu contains all the menus required for the commissioning, configuration and operation of the device.

Main menu and navigation

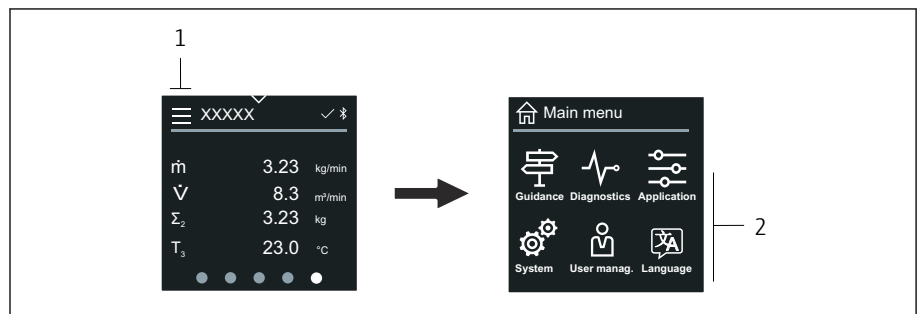

A0044213



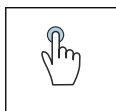



- 1 Open the main menu.
- 2 Open menus for the specific device functions.



Tap

- Back to operational display.
- Open menus.

Symbols

-  Back to operational display.
-  **Guidance** menu
Configuration of the device
-  **Diagnostics** menu
Troubleshooting and control of device behavior
-  **Application** menu
Application-specific adjustments
-  **System** menu
Device management and user administration
-  Set display language.

Submenus and navigation

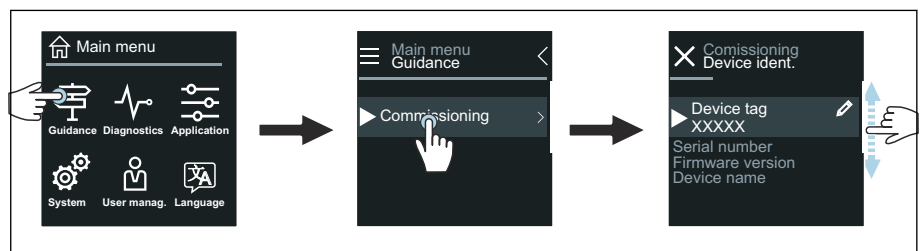

A0044219

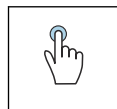

Tap

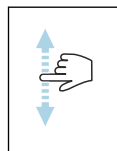

- Open the main menu.
- Open submenus or parameters.
- Select options.
- Skip items in list.



Swipe vertically

Select items in a list on a step-by-step basis.

Symbols

-  Return to previous menu.
-  Skip to bottom of list.
-  Skip to top of list.

Diagnostic information

Diagnostic information displays additional instructions or background information for diagnostic events.

Opening the diagnostic message

-  The diagnostic behavior is indicated on the top right of the local display by a diagnostics symbol. Tap the symbol or the "Help" button to open the diagnostic message.

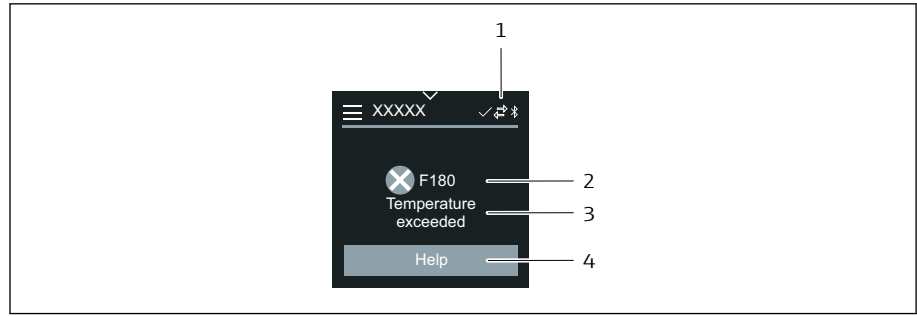

A0043008

- 1 Device status
- 2 Diagnostic behavior with diagnostic code
- 3 Short text
- 4 Open the troubleshooting measures.

Editing view

Editor and navigation

The text editor is used to enter characters.

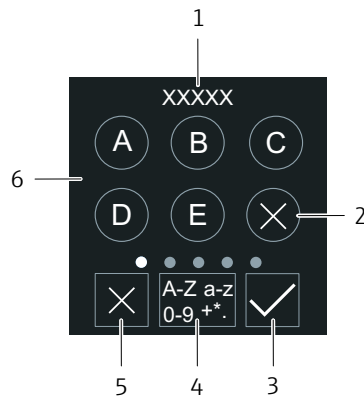

A0043020

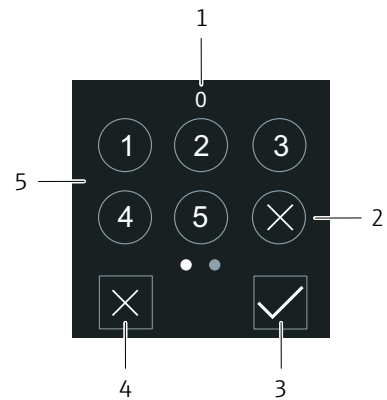

A0043023

- 1 Entry display area
- 2 Delete character.
- 3 Confirm your entry.
- 4 Switch input field.
- 5 Cancel editor.
- 6 Input field

- 1 Entry display area
- 2 Delete character.
- 3 Confirm your entry.
- 4 Cancel editor.
- 5 Input field

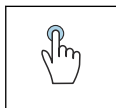

Tap

- Enter characters.
- Select next character set.

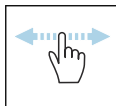

Swipe horizontally

Display next or previous page.

Input field

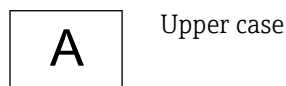



Numbers

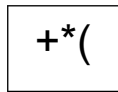

Special characters

Date

The device has a real-time clock for all log functions. The time can be configured here.

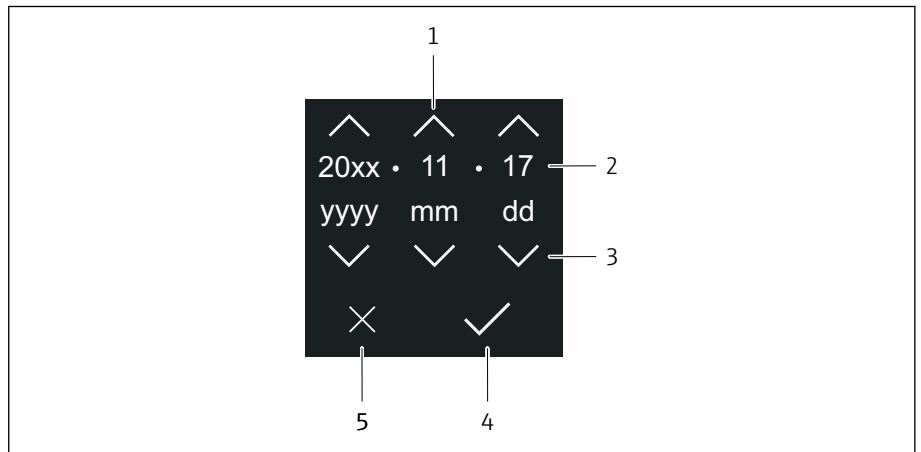

A0043043

- 1 Increase date by 1.
- 2 Actual value
- 3 Decrease date by 1.
- 4 Confirm settings.
- 5 Cancel editor.

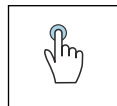



Tap

- Make settings.
- Confirm settings.
- Cancel editor.

SmartBlue App

The device has a Bluetooth interface and can be operated and configured using the SmartBlue App. The SmartBlue App must be downloaded onto a terminal device for this purpose. Any terminal device can be used.

- The range is 20 m (65.6 ft) under reference conditions.
- Incorrect operation by unauthorized persons is prevented by means of encrypted communication and password encryption.
- Bluetooth can be disabled.



Download	<p>Endress+Hauser SmartBlue App:</p> <ul style="list-style-type: none">▪ Google Playstore (Android)▪ iTunes Apple Shop (iOS devices) <div data-bbox="906 353 1284 492"></div>
Supported functions	<ul style="list-style-type: none">▪ Configuration of the device▪ Access to measured values, device status and diagnostic information

7 System integration

Device description files	58
Measured variables via HART protocol	58

Device description files

Version data

Firmware version	01.00.zz	<ul style="list-style-type: none"> On the title page of the Operating instructions On the transmitter nameplate → <i>Transmitter nameplate</i>,  17 System → Information → Device → Firmware version
Release date of firmware version	04.2021	-
Manufacturer ID	0x11	Application → Communication → Information → Manufacturer ID
Device type ID	0x71	Application → Communication → Information → Device ID
HART protocol revision	7	Application → Communication → Information → HART revision
Device revision	1	<ul style="list-style-type: none"> On the transmitter nameplate → <i>Transmitter nameplate</i>,  17 Diagnostics → Device information → Device revision

Operating tools

The suitable device description file for the individual operating tools is listed in the table below, along with information on where the file can be obtained.

Operating tool via HART protocol	Sources for obtaining device descriptions
FieldCare	<ul style="list-style-type: none"> www.endress.com → Downloads CD-ROM (contact Endress+Hauser) DVD (contact Endress+Hauser)
DeviceCare	<ul style="list-style-type: none"> www.endress.com → Downloads CD-ROM (contact Endress+Hauser) DVD (contact Endress+Hauser)
<ul style="list-style-type: none"> Field Xpert SFX350 Field Xpert SFX370 	Update function via handheld terminal
AMS Device Manager (Emerson Process Management)	www.endress.com → Downloads
SIMATIC PDM (Siemens)	www.endress.com → Downloads
Field Communicator 475 (Emerson Process Management)	Update function via handheld terminal

Measured variables via HART protocol

 Technical data → *Protocol-specific data*,  93

Dynamic variables

The following measured variables (HART device variables) are assigned to the dynamic variables at the factory:

Primary dynamic variable (PV)	Volume flow
Secondary dynamic variable (SV)	Totalizer 1
Tertiary dynamic variable (TV)	Totalizer 2
Quaternary dynamic variable (QV)	Totalizer 3

The assignment can be configured in the **Output** submenu.

Navigation

Application → Communication → Output

- Assign PV
- Assign SV
- Assign TV
- Assign QV



Assignment and available measured variables: Description of Device
Parameters → 6

Device variables

The device variables are permanently assigned. A maximum of 8 device variables can be transmitted.



- | | |
|---|------------------------|
| 0 | Volume flow |
| 1 | Mass flow |
| 2 | Conductivity |
| 3 | Corrected conductivity |
| 4 | Temperature |
| 5 | Flow velocity |
| 6 | Electronic temperature |
| 7 | Totalizer 1 |
| 8 | Totalizer 2 |
| 9 | Totalizer 3 |

8 Commissioning

Post-installation check and post-connection check	62
IT security	62
Device-specific IT security	62
Switching on the device	63
Commissioning the device	64

Post-installation check and post-connection check

Before commissioning the device, make sure that the post-installation and post-connection checks have been performed:

- Post-installation check → *Post-installation check*,  34
- Post-connection check → *Post-connection check*,  47

IT security

We only provide a warranty if the device is installed and used as described in the Operating Instructions. The device is equipped with security mechanisms to protect it against any inadvertent changes to the device settings.

IT security measures in line with operators' security standards and designed to provide additional protection for the device and device data transfer must be implemented by the operators themselves.

Device-specific IT security

Access via Bluetooth

Secure signal transmission via Bluetooth uses an encryption method tested by the Fraunhofer Institute.

- Without the SmartBlue App, the device is not visible via Bluetooth.
- Only one point-to-point connection is established between the device and a smartphone or tablet.

Access via the SmartBlue App

Two access levels (user roles) are defined for the device: the **Operator** user role and the **Maintenance** user role. The **Maintenance** user role is configured when the device leaves the factory.

If a user-specific access code is not defined (in the Enter access code parameter), the default setting **0000** continues to apply and the **Maintenance** user role is automatically enabled. The device's configuration data are not write-protected and can be edited at all times.

If a user-specific access code has been defined (in the Enter access code parameter), all the parameters are write-protected. The device is accessed with the **Operator** user role. When the user-specific access code is entered a second time, the **Maintenance** user role is enabled. All parameters can be written to.



For detailed information, see the "Description of Device Parameters" document pertaining to the device.

Protecting access via a password

There are a variety of ways to protect against write access to the device parameters:

- User-specific access code:
Protect write access to the device parameters via all the interfaces.
- Bluetooth key:
The password protects access and the connection between an operating unit, e.g. a smartphone or tablet, and the device via the Bluetooth interface.

General notes on the use of passwords

- The access code and Bluetooth key supplied with the device must be defined during commissioning.
- Follow the general rules for generating a secure password when defining and managing the access code and Bluetooth key.
- The user is responsible for the management and careful handling of the access code and Bluetooth key.

Write protection switch

The entire operating menu can be locked via the write protection switch. The values of the parameters cannot be changed. Write protection is disabled when the device leaves the factory.

Access authorization with write protection:

- Disabled: write access to the parameters
- Enabled: read-only access to the parameters

Write protection is enabled with the write protection switch on the back of the display module → *Hardware settings*,  46.



 The local display indicates that write protection is activated on the top right of the screen: .

Switching on the device

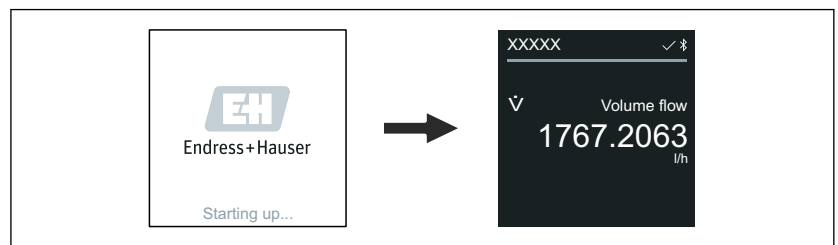
- ▶ Switch on the supply voltage for the device.
 - ↳ The local display switches from the start screen to the operational display.



A0042938

 If device startup is not successful, the device displays an error message to this effect → *Diagnostics and troubleshooting*,  70.

Commissioning the device

Local operation

 Detailed information on local operation: → *Operation*,  50

1. Via the "Menu" symbol, open the main menu.



A0042939

2. Via the "Language" symbol, select the desired language.

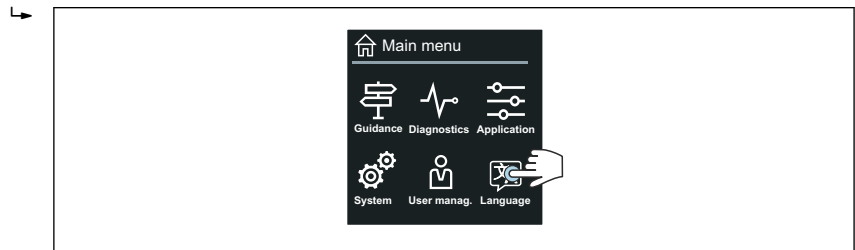

A0042940

3. Via the "Guidance" symbol, open the **Commissioning** wizard.

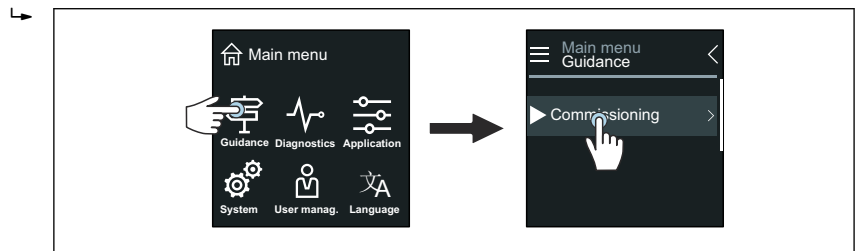

A0042941

4. Start the **Commissioning** wizard.

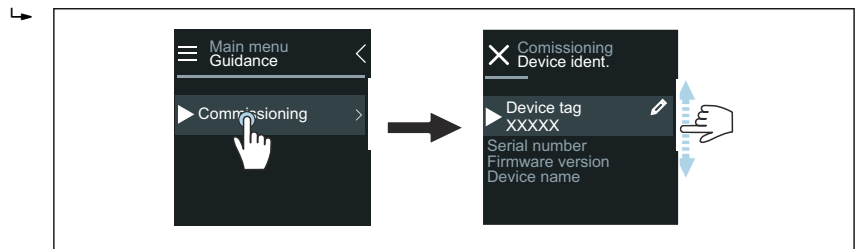

A0043018

5. Follow the instructions on the local display.
 - ↳ The **Commissioning** wizard goes through all the device parameters that are necessary to commission the device.

 For detailed information, see the "Description of Device Parameters" document pertaining to the device.

SmartBlue App

 Information on the SmartBlue App → *SmartBlue App*,  55.

Connecting the SmartBlue App to the device

1. Enable Bluetooth on the mobile handheld terminal, tablet or smartphone.
2. Start the SmartBlue App.
 - ↳ A Live List shows all the devices available.
3. Select the desired device.
 - ↳ The SmartBlue App shows the device login.
4. Under user name, enter **admin**.
5. Under password, enter the device's serial number. Serial number:
→ *Transmitter nameplate*, ⓘ 17.
6. Confirm your entries.
 - ↳ The SmartBlue App connects to the device and displays the main menu.

Opening the "Commissioning" wizard

1. Via the **Guidance** menu, open the **Commissioning** wizard.
2. Follow the instructions on the local display.
 - ↳ The **Commissioning** wizard goes through all the device parameters that are necessary to commission the device.

9 Operation

Reading the device locking status	68
HistoROM data management	68

Reading the device locking status

Indicates the write protection with the highest priority that is currently active.

Navigation

"System" menu → Device management → Locking status

Parameter overview with brief description

Parameter	Description	User interface
Locking status	Indicates the write protection with the highest priority that is currently active.	<ul style="list-style-type: none"> ▪ Hardware locked ▪ Temporarily locked

HistoROM data management

The device features HistoROM data management. Device data and process data can be saved, imported and exported with the HistoROM data management function, making operation and servicing far more reliable, secure and efficient.

Data backup

Automatic

The most important device data, e.g. the transmitter and sensor, are automatically saved in the S+T-DAT.

When the sensor is replaced, the customer-specific sensor data is adopted in the device. The device goes into operation immediately without any problems.

Manuell

The transmitter data (customer settings) must be saved manually.

Storage concept

	HistoROM backup	S+T-DAT
Available data	<ul style="list-style-type: none"> ▪ Event logbook, e.g. diagnostic events ▪ Parameter data record backup 	<ul style="list-style-type: none"> ▪ Sensor data, e.g. nominal diameter ▪ Serial number ▪ Calibration data ▪ Configuration of the device, e.g. software options
Storage location	On the sensor electronics module (ISEM)	In the sensor connector in the sensor neck

Data transfer

A parameter configuration can be transferred to another device using the export function of the operating tool. The parameter configuration can be duplicated or saved in an archive.

10 Diagnostics and troubleshooting

General troubleshooting	70
Diagnostic information via LED	72
Diagnostic information on local display	73
Diagnostic information in FieldCare or DeviceCare	74
Changing the diagnostic information	75
Overview of diagnostic information	76
Pending diagnostic events	79
Diagnostic list	80
Event logbook	80
Device reset	82

General troubleshooting

Local display

Error	Possible causes	Remedial action
Local display dark, no output signals	<p>Supply voltage does not match that specified on the nameplate.</p> <p>The polarity of the supply voltage is wrong.</p> <p>No contact between cables and terminals.</p> <p>Terminals are not plugged into the electronics module correctly.</p> <p>Electronics module is defective.</p>	<p>Apply the correct supply voltage.</p> <p>Correct the polarity.</p> <ul style="list-style-type: none"> ■ Check contact of cables. ■ Connect the cables to the terminals again. ■ Check the terminals. ■ Plug the terminals into the electronics module again. <p>Order the appropriate spare part.</p>
Local display is dark, but signal output is within the valid range.	<p>Incorrect contrast setting of local display.</p> <p>Cable connector for the local display is not correctly connected.</p> <p>Local display is defective.</p>	<p>Adjust the contrast of the local display to ambient conditions.</p> <p>Plug in the cable connector correctly.</p> <p>Order the appropriate spare part.</p>
Display alternates between error message and operational display	<p>Diagnostic event has occurred.</p>	<p>Carry out appropriate troubleshooting measures.</p>
Local display shows text in a foreign, incomprehensible language.	<p>A foreign language is set.</p>	<p>Set the language of the local display.</p>

Only for remote version



Error	Possible causes	Remedial action
Local display displays an error, no output signals	<p>Cable connectors between the electronics module and local display are not plugged in correctly.</p> <p>Electrode cable and coil current cable are not plugged in correctly.</p>	<p>Plug in the cable connector correctly.</p> <p>Plug in the electrode cable and coil current cable correctly.</p>

Output signal

Error	Possible causes	Remedial action
Signal output is outside the valid current range (< 3.5 mA or > 23 mA).	<p>Electronics module is defective.</p>	<p>Order the appropriate spare part.</p>
Local display shows the correct value, but signal output is incorrect, though in the valid range.	<p>Configuration error</p>	<ul style="list-style-type: none"> ■ Check parameter configuration. ■ Correct parameter configuration.

Error	Possible causes	Remedial action
Device measures incorrectly.	<ul style="list-style-type: none"> ■ Configuration error ■ The device is being operated outside the application range. 	<ul style="list-style-type: none"> ■ Check parameter configuration. ■ Correct parameter configuration. ■ Observe limit values indicated.
No signal at frequency output	Device uses passive frequency output.	Wire the device correctly as described in the Operating Instructions → <i>Electrical connection</i> ,  36.

Access and communication

Error	Possible causes	Remedial action
Not possible to write-access the parameter.	Write protection is enabled.	Set the write protection switch on the local display to the Off position.
	Current user role has limited access authorization.	<ol style="list-style-type: none"> 1. Check user role. 2. Enter correct customer-specific access code.
HART communication is not possible.	Load resistor missing or size is incorrect	<ul style="list-style-type: none"> ■ Load resistor must be at least 250 Ω. ■ Observe the maximum load → <i>Output signal</i>,  90. ■ → <i>Examples for electric terminals</i>,  150
	<ul style="list-style-type: none"> ■ Commubox is connected incorrectly. ■ Commubox is configured incorrectly. ■ Commubox driver is not installed correctly. ■ Wrong USB interface is configured on PC. 	Observe the documentation for the Commubox.  FXA195 HART: Document "Technical Information" TI00404F
Device communication is not possible.	Data transfer is active.	Wait until the data transfer or the current action is finished.
SmartBlue App does not show the device in the live list.	<ul style="list-style-type: none"> ■ Bluetooth is disabled on the device. ■ Bluetooth is disabled on the smartphone or tablet. 	<ol style="list-style-type: none"> 1. Check whether the Bluetooth symbol appears on the local display. 2. Enable Bluetooth on the device. 3. Enable Bluetooth on the smartphone or tablet.
Device cannot be operated with the SmartBlue App.	<ul style="list-style-type: none"> ■ Bluetooth connection is not available. ■ The device is already connected to another smartphone or tablet. ■ Incorrect password entered. ■ Password forgotten. 	<ol style="list-style-type: none"> 1. Check whether other devices are connected to the SmartBlue App. 2. Disconnect any other device connected to the SmartBlue App. <ol style="list-style-type: none"> 1. Enter correct password. 2. Contact Endress+Hauser service organization.

Error	Possible causes	Remedial action
Login with user data is not possible with the SmartBlue App.	Device in operation for the first time.	<ol style="list-style-type: none"> 1. Enter the initial password (serial number of the device). 2. Change the initial password.
No connection via service interface	<ul style="list-style-type: none"> ■ Commubox driver is not installed correctly. ■ Wrong USB interface is configured on PC. 	Observe the documentation for the Commubox.  FXA291 HART: Document "Technical Information" TI00405C

Diagnostic information via LED

Only for devices with the order code for "Display; operation", option H

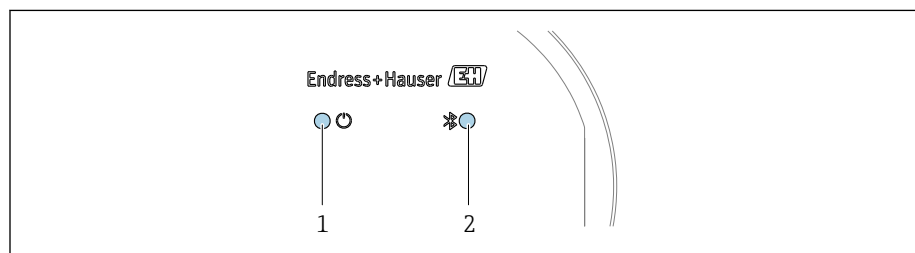

A0044231

- 1 Device status
- 2 Bluetooth

LED	Status	Meaning
1 Device status (normal operation)	Off	No power supply
	Permanently green	Device status is OK. No warning / failure / alarm
	Flashing red	Warning is active.
	Permanently red	Alarm is active.
2 Bluetooth	Off	Bluetooth is disabled.
	Permanently blue	Bluetooth is enabled.
	Flashing blue	Data transfer in progress.

Diagnostic information on local display

Diagnostic message

The local display alternates between displaying faults as a diagnostic message and displaying the operational display screen.

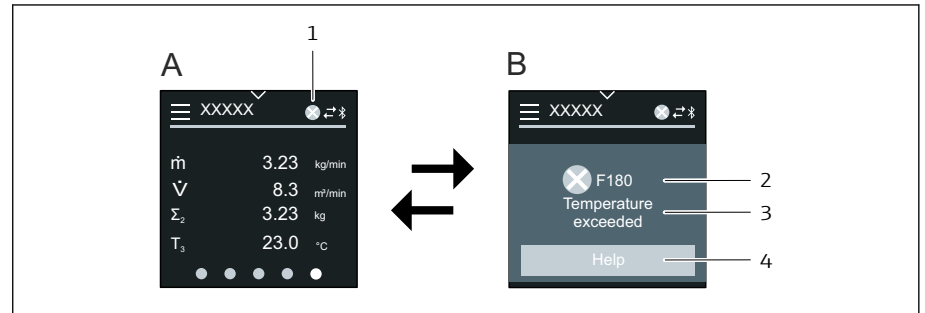

- A Operational display in alarm condition
- B Diagnostic message
- 1 Diagnostic behavior
- 2 Status signal
- 3 Diagnostic behavior with diagnostic code
- 4 Short text
- 5 Open information on remedial measures.

If two or more diagnostics events are pending simultaneously, the local display only shows the diagnostic message with the highest priority.

- i** Other diagnostic events that have occurred can be opened in the **Diagnostics** menu as follows:
 - Via parameters
 - Via submenus

Status signals

The status signals provide information on the state and reliability of the device by categorizing the cause of the diagnostic information (diagnostic event).

- i** The status signals are categorized according to NAMUR Recommendation NE 107: F = Failure, C = Function Check, S = Out of Specification, M = Maintenance Required, N = No Effect

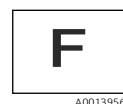

- Failure**
- A device error has occurred.
 - Measured value is no longer valid.

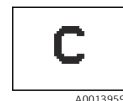

- Function check**
- Device is in the service mode, e.g. during a simulation.

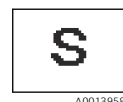

- Out of specification**
- Device is being operated outside the technical specification limits, e.g. outside the process temperature range.
 - Device is being operated outside the configuration carried out by the user, e.g. max. flow in the 20 mA value parameter.



- Maintenance required**
- Maintenance is required.
 - Measured value is still valid.

Diagnostic information

The fault can be identified using the diagnostic information. The short text displays a tip about the fault.

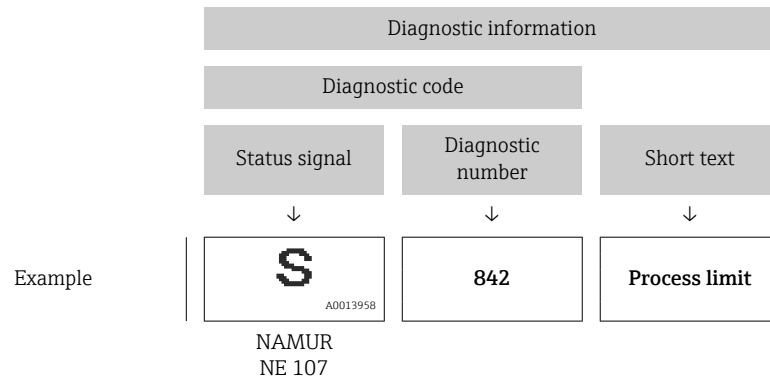
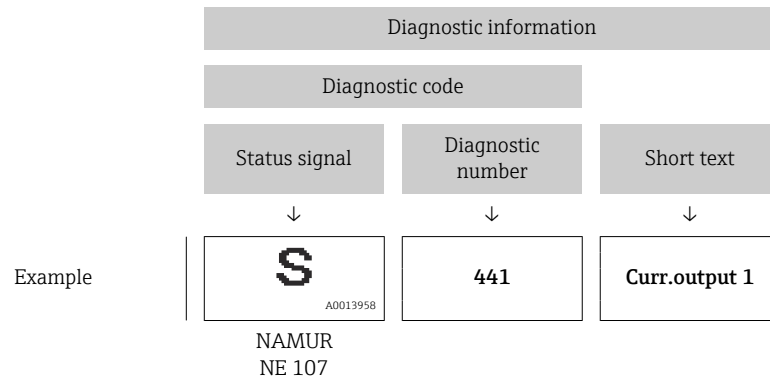

Diagnostic information in FieldCare or DeviceCare

Diagnostic options

After the connection has been established, the device shows faults on the home page.

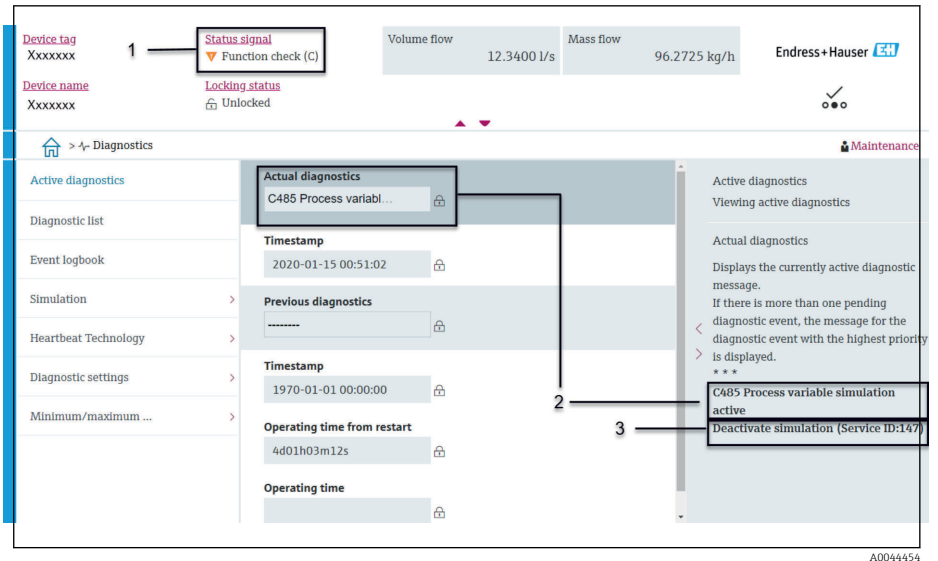

- 1 Status area with diagnostic behavior and status signal
- 2 Diagnostic code and short message
- 3 Troubleshooting measures with service ID

i Other diagnostic events that have occurred can be opened in the **Diagnostics** menu as follows:

- Via parameter
- Via submenus

Diagnostic information

The fault can be identified using the diagnostic information. The short text displays a tip about the fault. The corresponding symbol for the diagnostic behavior appears at the start.

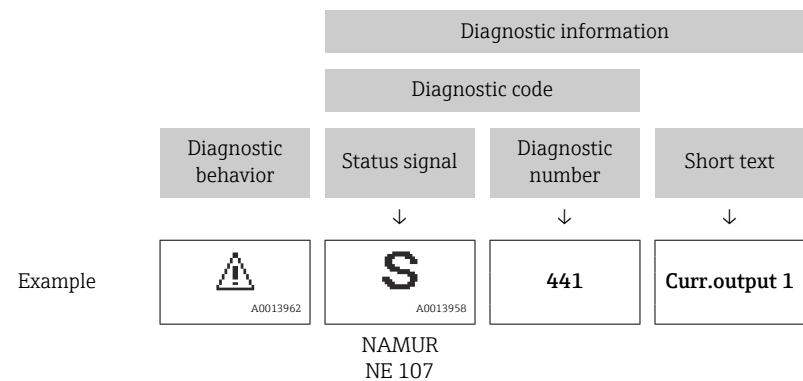

Changing the diagnostic information

Adapting the status signal

Each item of diagnostic information is assigned a specific status signal at the factory. The user can change the assignment for specific diagnostic information in the **"Diagnostic settings"** submenu.

Navigation path

Diagnostics → Diagnostic settings

Configuration of the device as per HART 7 Specification (Condensed Status), in accordance with NAMUR NE107.



Failure

- A device error has occurred.
- Measured value is no longer valid.



Function check

Device is in the service mode, e.g. during a simulation.

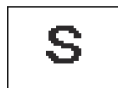

Out of specification

- Device is being operated outside the technical specification limits, e.g. outside the process temperature range.
- Device is being operated outside the configuration carried out by the user, e.g. max. flow in the 20 mA value parameter.



Maintenance required

- Maintenance is required.
- Measured value is still valid.

Adapting the diagnostic behavior

Each item of diagnostic information is assigned a specific diagnostic behavior at the factory. The user can change the assignment for specific diagnostic information in the **Diagnostic settings** submenu.

Navigation path

Diagnostics → Diagnostic settings

You can assign the following options to the diagnostic number as the diagnostic behavior:

Options	Description
Alarm	<ul style="list-style-type: none"> ▪ Device stops measurement. ▪ Signal outputs and totalizers assume a defined alarm condition. ▪ Diagnostic message is generated. ▪ Background lighting changes to red.
Warning	<ul style="list-style-type: none"> ▪ Device continues measuring. ▪ Signal outputs and totalizers are not affected. ▪ Diagnostic message is generated.
Logbook entry only	<ul style="list-style-type: none"> ▪ Device continues measuring. ▪ The local display shows the diagnostic message in the Event logbook submenu (Event list submenu) and does not alternate with the operational display.
Off	<ul style="list-style-type: none"> ▪ Diagnostic event is ignored. ▪ Diagnostic message is not generated and not entered.

Overview of diagnostic information



The amount of diagnostic information and the number of measured variables affected increase if the device has one or more application packages.

Diagnostic number	Short text	Remedy instructions	Status signal [from the factory]	Diagnostic behavior [from the factory]
Diagnostic of sensor				
043	Sensor 1 short circuit detected	1. Check sensor cable and sensor 2. Execute Heartbeat Verification 3. Replace sensor cable or sensor	S	Warning ¹⁾
082	Data storage inconsistent	1. Check module connections 2. Contact service	F	Alarm
083	Memory content inconsistent	1. Restart device 2. Restore HistoROM S-DAT backup ('Device reset' parameter) 3. Replace HistoROM S-DAT	F	Alarm
168	Build-up detected	Clean measuring tube	M	Warning
169	Conductivity measurement failed	1. Check grounding conditions 2. Deactivate conductivity measurement	M	Warning
170	Coil resistance faulty	Check ambient and process temperature	F	Alarm
180	Temperature sensor defective	1. Check sensor connections 2. Replace sensor cable or sensor 3. Turn off temperature measurement	F	Warning
181	Sensor connection faulty	1. Check sensor cable and sensor 2. Execute Heartbeat Verification 3. Replace sensor cable or sensor	F	Alarm
Diagnostic of electronic				
201	Electronics faulty	1. Restart device 2. Contact service	F	Alarm
230	Date/time incorrect	1. Replace RTC buffer battery 2. Set date and time	M	Warning ¹⁾
231	Date/time not available	1. Replace display module or its cable 2. Set date and time	M	Warning ¹⁾
242	Firmware incompatible	1. Check firmware version 2. Flash or replace electronic module	F	Alarm
252	Module incompatible	1. Check electronic modules 2. Check if correct modules are available (e.g. NEx, Ex) 3. Replace electronic modules	F	Alarm
278	Display module defective	Replace display module	F	Alarm
283	Memory content inconsistent	1. Reset device 2. Contact service	F	Alarm
302	Device verification active	Device verification active, please wait.	C	Warning ¹⁾
311	Sensor electronics (ISEM) faulty	1. Do not reset device 2. Contact service	M	Warning

Diagnostic number	Short text	Remedy instructions	Status signal [from the factory]	Diagnostic behavior [from the factory]
331	Firmware update failed in module 1 to n	1. Update firmware of device 2. Restart device	F	Warning
372	Sensor electronics (ISEM) faulty	1. Restart device 2. Check if failure recurs 3. Replace sensor electronic module (ISEM)	F	Alarm
373	Sensor electronics (ISEM) faulty	Contact service	F	Alarm
376	Sensor electronics (ISEM) faulty	1. Replace sensor electronic module (ISEM) 2. Turn off diagnostic message	S	Warning ¹⁾
377	Sensor electronics (ISEM) faulty	1. Activate empty pipe detection 2. Check partial filled pipe and installation direction 3. Check sensor cabling 4. Deactivate diagnostics 377	S	Warning ¹⁾
378	Electronic module supply voltage faulty	Check supply voltage to the ISEM	F	Alarm
383	Memory content	1. Restart device 2. Delete T-DAT via 'Reset device' parameter 3. Replace T-DAT	F	Alarm
387	HistoROM data faulty	Contact service organization	F	Alarm
Diagnostic of configuration				
410	Data transfer failed	1. Check connection 2. Retry data transfer	F	Alarm
412	Processing download	Download active, please wait	C	Warning
431	Trim 1 required	Carry out trim	C	Warning
437	Configuration incompatible	1. Restart device 2. Contact service	F	Alarm
438	Dataset different	1. Check data set file 2. Check device configuration 3. Up- and download new configuration	M	Warning
441	Current output faulty	1. Check process 2. Check current output settings	S	Warning ¹⁾
442	Frequency output faulty	1. Check process 2. Check frequency output settings	S	Warning ¹⁾
443	Pulse output 1 faulty	1. Check process 2. Check pulse output settings	S	Warning ¹⁾
453	Flow override active	Deactivate flow override	C	Warning
484	Failure mode simulation active	Deactivate simulation	C	Alarm
485	Process variable simulation active	Deactivate simulation	C	Warning
491	Current output 1 simulation active	Deactivate simulation	C	Warning

Diagnostic number	Short text	Remedy instructions	Status signal [from the factory]	Diagnostic behavior [from the factory]
492	Frequency output simulation active	Deactivate simulation frequency output	C	Warning
493	Pulse output simulation active	Deactivate simulation pulse output	C	Warning
494	Switch output simulation active	Deactivate simulation switch output	C	Warning
495	Diagnostic event simulation active	Deactivate simulation	C	Warning
511	ISEM settings faulty	1. Check measuring period and integration time 2. Check sensor properties	C	Alarm
Diagnostic of process				
832	Sensor electronics temperature too high	Reduce ambient temperature	S	Warning ¹⁾
833	Sensor electronics temperature too low	Increase ambient temperature	S	Warning ¹⁾
834	Process temperature too high	Reduce process temperature	S	Warning ¹⁾
835	Process temperature too low	Increase process temperature	S	Warning ¹⁾
842	Process value above limit	1. Decrease process value 2. Check application 3. Check sensor	S	Warning ¹⁾
937	Sensor symmetry	1. Eliminate external magnetic field near sensor 2. Turn off diagnostic message	S	Warning ¹⁾
938	EMC interference	1. Check ambient conditions regarding EMC influence 2. Turn off diagnostic message	F	Alarm ¹⁾
944	Monitoring failed	Check process conditions for Heartbeat Monitoring	S	Warning
961	Electrode potential out of specification	1. Check process conditions 2. Check ambient conditions	S	Warning ¹⁾
962	Pipe empty	1. Perform full pipe adjustment 2. Perform empty pipe adjustment 3. Turn off empty pipe detection	S	Warning ¹⁾

1) Diagnostic behavior can be changed.

Pending diagnostic events

The **Active diagnostics** submenu displays the current diagnostic event and the last diagnostic event to occur.

Diagnostics → Active diagnostics



The **Diagnostic list** submenu shows other diagnostic events that are pending.

Diagnostic list

The **Diagnostic list** submenu shows up to 5 currently pending diagnostic events with the related diagnostic information. If more than 5 diagnostic events are pending, the local display shows the diagnostic information with the highest priority.

Navigation path

Diagnostics → Diagnostic list

Event logbook

Reading out the event logbook

 The event logbook is only available via FieldCare or SmartBlue App (Bluetooth).



The **Event logbook** submenu shows a chronological overview of the event messages that have occurred.

Navigation path



Diagnostics menu → **Event logbook** submenu

Chronological display with a maximum of 20 event messages.

The event history includes the following entries:

- Diagnostic event → *Overview of diagnostic information*,  76
- Information event → *Overview of information events*,  80

In addition to the operation time of the event occurrence, each event is also assigned a symbol that indicates whether the event has occurred or has ended:

- Diagnostic event
 - : Occurrence of the event
 - : End of the event
- Information event
 - : Occurrence of the event

 Filter event messages:

Filtering the event logbook

The **Event logbook** submenu displays the category of event messages that were configured with the **Filter options** parameter.

Navigation path

Diagnostics → Event logbook → Filter options

Filter categories

- All
- Failure (F)
- Function check (C)
- Out of specification (S)
- Maintenance required (M)
- Information (I)

Overview of information events

The information event is only displayed in the event logbook.

Info number	Info name
I1000	----- (Device ok)
I1079	Sensor changed
I1089	Power on
I1090	Configuration reset
I1091	Configuration changed
I11036	Date/time set successfully
I11167	Date/time resynchronized
I1137	Display module replaced
I1151	History reset
I1155	Sensor electronics temperature reset
I1157	Memory error event list
I1256	Display: access status changed
I1335	Firmware changed
I1351	Empty pipe detection adjustment failure
I1353	Empty pipe detection adjustment ok
I1397	Fieldbus: access status changed
I1398	CDI: access status changed
I1443	Build-up thickness not determined
I1444	Device verification passed
I1445	Device verification failed
I1459	I/O module verification failed
I1461	Sensor verification failed
I1462	Sensor electronic module verific. failed
I1512	Download started
I1513	Download finished
I1514	Upload started
I1515	Upload finished
I1622	Calibration changed
I1624	All totalizers reset
I1625	Write protection activated
I1626	Write protection deactivated
I1629	CDI: login successful
I1632	Display: login failed
I1633	CDI: login failed
I1634	Reset to factory settings
I1635	Reset to delivery settings
I1649	Hardware write protection activated
I1650	Hardware write protection deactivated
I1712	New flash file received
I1725	Sensor electronic module (ISEM) changed

Device reset

The entire configuration, or a part of the configuration, can be reset to a defined state here.

Navigation path

System → Device management → Device reset

Options	Description
To delivery settings	Every parameter for which a customer-specific default setting was ordered is reset to the customer-specific value. All other parameters are reset to the factory setting.
Of customer settings	Visibility depends on order options or device settings
Restart device	The restart resets every parameter with data stored in volatile memory (RAM) to the factory setting (e.g. measured value data). The device configuration remains unchanged.
Restore S-DAT backup	Restore the data that is saved on the S-DAT. The data record is restored from the electronics memory to the S-DAT. Visibility depends on order options or device settings  The local display only displays this option in an alarm condition.

11 Maintenance

Maintenance tasks	84
Services	84

Maintenance tasks

The device is maintenance-free. Modifications or repairs may only be carried out following consultation with an Endress+Hauser service organization. It is recommended to examine the device regularly for corrosion, mechanical wear and damage.

Exterior cleaning

Clean the device as follows:

- Use a dry or slightly damp lint-free cloth.
- Do not use sharp objects or aggressive cleaning agents.
- Do not use high-pressure steam.

Interior cleaning

Cleaning with pigs

Observe the inside diameters of the measuring pipe and process connection.

Replacement seals

The sensor's seals (particularly aseptic gasket seals) must be replaced periodically.

The replacement interval depends on:

- The frequency of the cleaning cycles
- The medium temperature
- The cleaning temperature

Replacement seals (accessory part)

Services

Endress+Hauser offers a wide range of services for device maintenance, e.g. recalibration, maintenance service or device tests.

Endress+Hauser sales organizations can provide information about the services available.

12 Disposal

Removing the device	86
Disposing of the device	86

Removing the device

1. Disconnect the device from the supply voltage.
2. Remove all connecting cables.

⚠ WARNING

Process conditions can put staff at risk!

- ▶ Wear suitable protective equipment.
- ▶ Allow the device and pipe to cool.
- ▶ Empty the device and pipe so that they are unpressurized.
- ▶ Rinse the device and pipe if necessary.

3. Remove the device correctly.

Disposing of the device

⚠ WARNING

Dangerous media can endanger staff and the environment!

- ▶ Ensure that the device and all cavities are free of medium residues that are hazardous to health or the environment, e.g. substances that have permeated into crevices or diffused through plastic.



A0042336

If required by the Directive 2012/19/EU of the European Parliament and the Council of 4 July 2012 on waste electrical and electronic equipment (WEEE), the device is marked with the depicted symbol in order to minimize the disposal of WEEE as unsorted municipal waste.

- Do not dispose of devices bearing this marking as unsorted municipal waste. Instead, return them to Endress+Hauser for disposal under the applicable conditions.
- Observe applicable federal/national regulations.
- Ensure proper separation and reuse of the device components.
- Overview of installed materials: → *Materials*, 107

13 Specifications

Input	88
Output	90
Power supply	94
Cable specification	96
Performance characteristics	97
Environment	99
Process	101
Mechanical construction	106
Local display	109
Certificates and approvals	110
Application packages	111

Input

Measured variable

Direct measured variables	<ul style="list-style-type: none"> ■ Volume flow (proportional to induced voltage) ■ Conductivity (order code for "Sensor Option", option CX) ■ Temperature (DN 15 to 150 (½" to 6") with order code for "Sensor option", option CI "Medium temperature measurement")
Calculated measured variables	<ul style="list-style-type: none"> ■ Mass flow ■ Corrected conductivity (DN 15 to 150 (½" to 6") with order code for "Sensor option", option CI "Medium temperature measurement" and order code for "Functionality", option D)

Operable flow range

Over 1000 : 1

Measuring range

Typically $v = 0.01$ to 10 m/s (0.03 to 33 ft/s) with the specified accuracy

Electrical conductivity: ≥ 5 $\mu\text{S/cm}$ for liquids in general

Flow characteristic values in SI units: DN 2 to 150 (½" to 6")

Nominal diameter		Recommended flow min./max. full scale value ($v \sim 0.3/10$ m/s)	Full scale value current output ($v \sim 2.5$ m/s)	Factory settings	
[mm]	[in]			Pulse value (~ 2 pulse/s)	Low flow cut off ($v \sim 0.04$ m/s)
		[dm ³ /min]	[dm ³ /min]	[dm ³]	[dm ³ /min]
2	½ ₁₂	0.06 to 1.8	0.5	0.005	0.01
4	⅝ ₂	0.25 to 7	2	0.025	0.05
8	⅝ ₁₆	1 to 30	8	0.1	0.1
15	½	4 to 100	25	0.2	0.5
25	1	9 to 300	75	0.5	1
40	1 ½	25 to 700	200	1.5	3
50	2	35 to 1100	300	2.5	5
65	–	60 to 2000	500	5	8
80	3	90 to 3000	750	5	12
100	4	145 to 4700	1200	10	20
125	5	220 to 7500	1850	15	30
150	6	330 to 10000	2500	30	42

Flow characteristic values in US units: 1/12 - 6" (DN 2 - 150)

Nominal diameter		Recommended flow min./max. full scale value (v ~ 0.3/10 m/s)	Full scale value current output (v ~ 2.5 m/s)	Factory settings	
[in]	[mm]			Pulse value (~ 2 pulse/s)	Low flow cut off (v ~ 0.04 m/s)
		[gal/min]	[gal/min]	[gal]	[gal/min]
1/12	2	0.015 to 0.5	0.1	0.001	0.002
1/32	4	0.07 to 2	0.5	0.005	0.008
5/16	8	0.25 to 8	2	0.02	0.025
1/2	15	1 to 27	6	0.05	0.1
1	25	2.5 to 80	18	0.2	0.25
1 1/2	40	7 to 190	50	0.5	0.75
2	50	10 to 300	75	0.5	1.25
3	80	24 to 800	200	2	2.5
4	100	40 to 1250	300	2	4
5	125	60 to 1950	450	5	7
6	150	90 to 2 650	600	5	12

Output

Output signal

Output versions

Order code for 020: output; input	Output version
Option B	<ul style="list-style-type: none"> ■ Current output 4 to 20 mA HART ■ Pulse/frequency/switch output

Current output 4 to 20 mA HART

Signal mode	Choose via terminal assignment: <ul style="list-style-type: none"> ■ Active ■ Passive
Current range	Can be set to: <ul style="list-style-type: none"> ■ 4 to 20 mA NAMUR ■ 4 to 20 mA US ■ 4 to 20 mA ■ Fixed current
Max. output current	21.5 mA
Open-circuit voltage	DC < 28.8 V (active)
Max. input voltage	DC 30 V (passive)
Max. load	400 Ω
Resolution	1 μA
Damping	Configurable: 0 to 999.9 s
Assignable measured variables	<ul style="list-style-type: none"> ■ Off ■ Volume flow ■ Mass flow ■ Temperature* ■ Flow velocity ■ Conductivity* ■ Corrected conductivity* ■ Electronic temperature ■ Noise* ■ Coil current shot time* ■ Reference electrode potential against PE* <p>* Visibility depends on order options or device settings</p>

Pulse/frequency/switch output

Function	Can be set to: <ul style="list-style-type: none"> ■ Pulse output ■ Frequency output ■ Switch output
Version	Open collector: Passive

Input values	<ul style="list-style-type: none"> ▪ DC 10.4 to 30 V ▪ Max. 140 mA
Voltage drop	<ul style="list-style-type: none"> ▪ ≤ DC 2 V @ 100 mA ▪ ≤ DC 2.5 V @ max. input current
Pulse output	
Pulse width	Configurable: 0.05 to 2 000 ms
Max. pulse rate	10 000 Impulse/s
Pulse value	Configurable
Assignable measured variables	<ul style="list-style-type: none"> ▪ Volume flow ▪ Mass flow
Frequency output	
Output frequency	Configurable: end value frequency 2 to 10 000 Hz ($f_{\max} = 12\,500$ Hz)
Damping	Configurable: 0 to 999.9 s
Pulse/pause ratio	1:1
Assignable measured variables	<ul style="list-style-type: none"> ▪ Off ▪ Volume flow ▪ Mass flow ▪ Temperature* ▪ Flow velocity ▪ Conductivity* ▪ Corrected conductivity* ▪ Electronic temperature ▪ Noise* ▪ Coil current shot time* ▪ Reference electrode potential against PE* <p>* Visibility depends on order options or device settings</p>
Switch output	
Switching behavior	Binary, conductive or non-conductive
Switching delay	Configurable: 0 to 100 s

Number of switching cycles	Unlimited
Assignable functions	<ul style="list-style-type: none">■ Off■ On■ Diagnostic behavior:<ul style="list-style-type: none">■ Alarm■ Warning■ Warning and alarm■ Limit value:<ul style="list-style-type: none">■ Off■ Volume flow■ Mass flow■ Temperature*■ Flow velocity■ Conductivity*■ Corrected conductivity*■ Totalizer 1...3■ Electronic temperature■ Flow direction monitoring■ Status<ul style="list-style-type: none">■ Empty pipe detection■ Low flow cut off <p>* Visibility depends on order options or device settings</p>

Signal on alarm

Output behavior in the event of a device alarm (failure mode)

HART

Device diagnostics	Device condition can be read out via HART Command 48
---------------------------	--

Current output 4 to 20 mA

4 to 20 mA	Selectable: <ul style="list-style-type: none"> ▪ Min. value: 3.59 mA ▪ Max. value: 21.5 mA ▪ Freely definable value between: 3.59 to 21.5 mA ▪ Actual value ▪ Last valid value
-------------------	---

Pulse/frequency/switch output

Pulse output	Selectable: <ul style="list-style-type: none"> ▪ Actual value ▪ No pulses
Frequency output	Selectable: <ul style="list-style-type: none"> ▪ Actual value ▪ 0 Hz ▪ Defined value: 0 to 12 500 Hz
Switch output	Selectable: <ul style="list-style-type: none"> ▪ Current status ▪ Open ▪ Closed

Low flow cut off

The switch points for low flow cut off are user-selectable.

Galvanic isolation

The outputs are galvanically isolated from one another and from earth.

Protocol-specific data

Bus structure	The HART signal overlays the 4 to 20 mA current output.
Manufacturer ID	0x11
Device type ID	0x71
HART protocol revision	7
Device description files (DTM, DD)	Information and files under: www.endress.com
HART load	At least 250 Ω
System integration	Measured variables via HART protocol

Power supply

Terminal assignment

 The terminal assignment is documented on an adhesive label.

The following terminal assignment is available:

Current output 4 to 20 mA HART (active) and pulse/frequency/switch output

Supply voltage		Output 1				Output 2	
1 (+)	2 (-)	26 (+)	27 (-)	24 (+)	25 (-)	22 (+)	23 (-)
L/+	N/-	Current output 4 to 20 mA HART (active)		-		Pulse/frequency/switch output (passive)	

Current output 4 to 20 mA HART (passive) and pulse/frequency/switch output

Supply voltage		Output 1				Output 2	
1 (+)	2 (-)	26 (+)	27 (-)	24 (+)	25 (-)	22 (+)	23 (-)
L/+	N/-	-		Current output 4 to 20 mA HART (passive)		Pulse/frequency/switch output (passive)	

Supply voltage

Order code for "Power supply"	Terminal voltage		Frequency range
Option D	DC 24 V	-20 to +30 %	-
Option E	AC 100 to 240 V	-15 to +10 %	50/60 Hz, ±5 Hz
Option I	DC 24 V	-20 to +30 %	-
	AC 100 to 240 V	-15 to +10 %	50/60 Hz, ±5 Hz
Option M non-hazardous area	DC 24 V	-20 to +30 %	-
	AC 100 to 240 V	-15 to +10 %	50/60 Hz, ±5 Hz

Power consumption

- Transmitter: max. 10 W (active power)
- Switch-on current: max. 36 A (< 5 ms) as per NAMUR Recommendation NE 21

Current consumption

- Max. 400 mA (24 V)
- Max. 200 mA (110 V, 50/60 Hz; 230 V, 50/60 Hz)

Power supply failure

- Totalizers stop at the last value measured.
- Device configuration remains unchanged.
- Error messages (incl. total operated hours) are stored.

Terminals

Spring terminals

- Suitable for strands and strands with ferrules.
- Conductor cross-section 0.2 to 2.5 mm² (24 to 12 AWG).

Cable entries

- Cable gland: M20 × 1.5 for cable Ø6 to 12 mm (0.24 to 0.47 in)
- Thread for cable entry:
 - NPT ½"
 - G ½", G ½" Ex d
 - M20

Cable specification

Requirements for connecting cable

Electrical safety

As per applicable national regulations.

Permitted temperature range

- Observe the installation guidelines that apply in the country of installation.
- The cables must be suitable for the minimum temperatures and maximum temperatures to be expected.

Power supply cable (incl. conductor for the inner ground terminal)

- A standard installation cable is sufficient.
- Provide grounding according to applicable national codes and regulations.

Signal cable

- Current output 4 to 20 mA HART:
A shielded cable is recommended, observe the grounding concept of the facility.
- Pulse/frequency/switch output:
Standard installation cable

Ground cable requirements

Copper wire: at least 6 mm² (0.0093 in²)

Connecting cable requirements

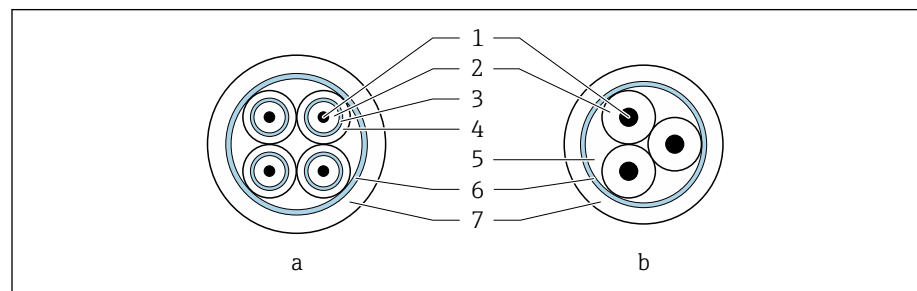

8 Cable cross-section

- a Electrode cable
- b Coil current cable
- 1 Core
- 2 Core insulation
- 3 Core shield
- 4 Core jacket
- 5 Core reinforcement
- 6 Cable shield
- 7 Outer jacket

Electrode cable

Design	3×0.38 mm ² (20 AWG) with common, braided copper shield (∅ ~ 9.5 mm (0.37 in)) and individual shielded cores If using the empty pipe detection (EPD) function: 4×0.38 mm ² (20 AWG) with common, braided copper shield (∅ ~ 9.5 mm (0.37 in)) and individual shielded cores
Conductor resistance	≤ 50 Ω/km (0.015 Ω/ft)
Capacitance: core/shield	≤ 420 pF/m (128 pF/ft)
Cable length	Depending on the medium conductivity: maximum 200 m (656 ft)
Cable lengths (available for order)	5 m (15 ft), 10 m (30 ft), 20 m (60 ft) or variable length: maximum 200 m (656 ft)
Operating temperature	-20 to +80 °C (-4 to +176 °F)

Coil current cable

Design	3×0.38 mm ² (20 AWG) with common, braided copper shield (∅ ~ 9.5 mm (0.37 in)) and individual shielded cores
Conductor resistance	≤ 37 Ω/km (0.011 Ω/ft)
Capacitance: core/shield	≤ 120 pF/m (37 pF/ft)
Cable length	Depends on the medium conductivity, max. 200 m (656 ft)
Cable lengths (available for order)	5 m (15 ft), 10 m (30 ft), 20 m (60 ft) or variable length up to max. 200 m (656 ft)
Operating temperature	-20 to +80 °C (-4 to +176 °F)
Test voltage for cable insulation	≤ AC 1 433 V r.m.s. 50/60 Hz or ≥ DC 2 026 V

Performance characteristics

Reference operating conditions

- Error limits based on ISO 20456:2017
- Water, typically: +15 to +45 °C (+59 to +113 °F); 0.5 to 7 bar (73 to 101 psi)
- Data as indicated in the calibration protocol
- Accuracy based on accredited calibration rigs according to ISO 17025
- Reference temperature for conductivity measurement: 25 °C (77 °F)

 To obtain measured errors, use the *Applicator* sizing tool → *Service-specific accessory*,  147

Maximum measured error

o. r. = of reading

Error limits under reference operating conditions

Volume flow

±0.5 %o. r. ±1 mm/s (±0.04 in/s)

 Fluctuations in the supply voltage do not have any effect within the specified range.

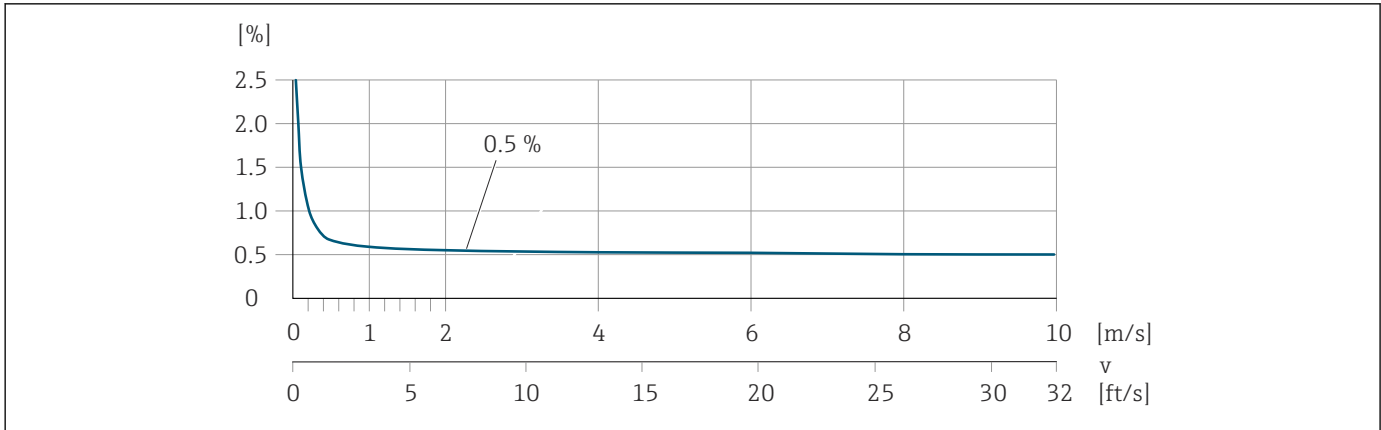

A0045827

Temperature

±3 °C (±5.4 °F)

Electrical conductivity

Max. measured error not specified.

Accuracy of outputs

Current output	±5 µA
Pulse/frequency output	Max. ±100 ppm o. r. (across the entire ambient temperature range)

Repeatability

Volume flow	Max. ±0.1 % o. r. ± 0.5 mm/s (0.02 in/s)
Electrical conductivity	<ul style="list-style-type: none"> ■ Max. ±5 % o. r. (5 to 100 000 µS/cm) ■ Max. ±1 % o. r. for DN 15 to 150 in conjunction with stainless steel process connections, 1.4404 (F316L)
Temperature	±0.5 °C (±0.9 °F)

Temperature measurement response time

T₉₀ < 15 s



Influence of ambient temperature

Current output	Temperature coefficient max. 1 µA/°C
Pulse/frequency output	No additional effect. Is included in the accuracy.

Environment

Ambient temperature range

Transmitter	-40 to +60 °C (-40 to +140 °F)
Local display	-20 to +60 °C (-4 to +140 °F) The readability of the display may be impaired at temperatures outside the temperature range.
Sensor	-40 to +60 °C (-40 to +140 °F)
Liner	Do not exceed or fall below the permitted temperature range of the liner .

 Dependency of ambient temperature on medium temperature → *Medium temperature range*,  101

Storage temperature

The storage temperature corresponds to the ambient temperature range of the transmitter and sensor.

Degree of protection

Transmitter	<ul style="list-style-type: none"> ▪ IP66/67, type 4X enclosure ▪ Open housing: IP20, type 1 enclosure
Sensor	IP66/67, type 4X enclosure

Vibration-resistance and shock-resistance

Compact version

Vibration, sinusoidal <ul style="list-style-type: none"> ▪ Following IEC 60068-2-6 ▪ 20 cycles per axis 	2 to 8.4 Hz	3.5 mm peak
	8.4 to 2 000 Hz	1 g peak
Vibration, broad-band random <ul style="list-style-type: none"> ▪ Following IEC 60068-2-64 ▪ 120 min per axis 	10 to 200 Hz	0.003 g ² /Hz
	200 to 2 000 Hz	0.001 g ² /Hz (1.54 g rms)
Shocks, half-sine <ul style="list-style-type: none"> ▪ Following IEC 60068-2-27 ▪ 3 positive and 3 negative shocks 	6 ms 30 g	

Shock

Due to rough handling according to IEC 60068-2-31.

Remote version (sensor)

Vibration, sinusoidal <ul style="list-style-type: none"> ▪ Following IEC 60068-2-6 ▪ 20 cycles per axis 	2 to 8.4 Hz	7.5 mm peak
	8.4 to 2 000 Hz	2 g peak
Vibration, broad-band random <ul style="list-style-type: none"> ▪ Following IEC 60068-2-6 ▪ 120 min per axis 	10 to 200 Hz	0.01 g ² /Hz
	200 to 2 000 Hz	0.003 g ² /Hz (2.7 g rms)

Shocks, half-sine

- Following IEC 60068-2-6
- 3 positive and 3 negative shocks

6 ms 50 g

Shock

Due to rough handling according to IEC 60068-2-31.

Interior cleaning

Available methods of internal cleaning:

- Cleaning in place (CIP)
- Sterilization in place (SIP)

Electromagnetic compatibility (EMC)

As per IEC/EN 61326 and NAMUR Recommendation NE 21.



For more information: Declaration of Conformity

Process

Medium temperature range

-20 to +150 °C (-4 to +302 °F)

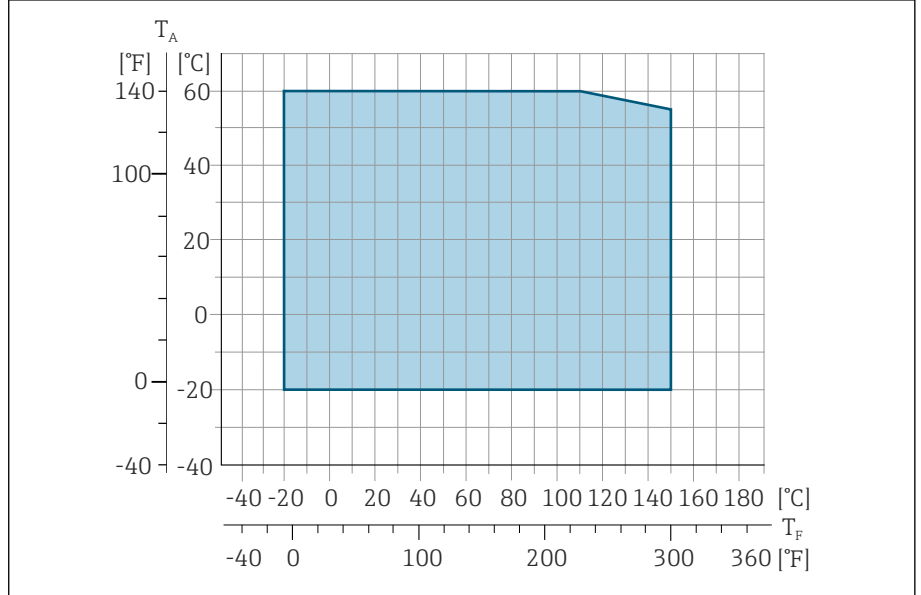

A0027450

T_A Ambient temperature

T_F Medium temperature

Conductivity

The necessary minimum conductivity is $\geq 5 \mu\text{S/cm}$.

i Note that in the case of the remote version, the minimum conductivity depends on the cable length.

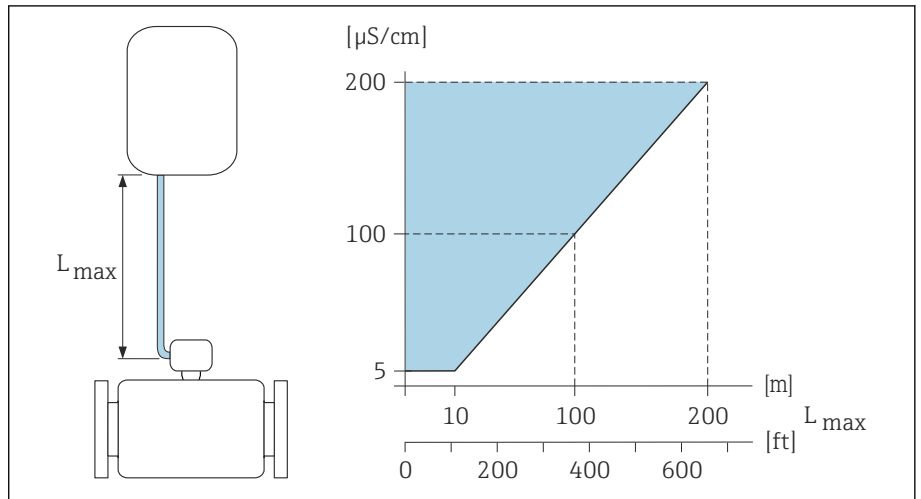

A0016539

9 Permitted length of connecting cable

Colored area = permitted range

L_{max} = length of connecting cable in [m] ([ft])

$[\mu\text{S/cm}]$ = medium conductivity

Flow limit

Pipe diameter and flow rate determine the nominal diameter of the sensor.

 The flow velocity is increased by reducing the sensor nominal diameter.

2 to 3 m/s (6.56 to 9.84 ft/s)	Optimum flow velocity
$v < 2$ m/s (6.56 ft/s)	For low conductivity values
$v > 2$ m/s (6.56 ft/s)	For media producing buildup, e.g. high-fat milk

Pressure-temperature ratings

Maximum permitted medium pressure as a function of the medium temperature.

The data relate to all pressure bearing parts of the device.

Process connections with O-ring seal, DN 2 to 25 (1/12 to 1")

Maximum permitted medium pressure as a function of the medium temperature.

The data relate to all pressure bearing parts of the device.

Fixed flange according to EN 1092-1

Stainless steel

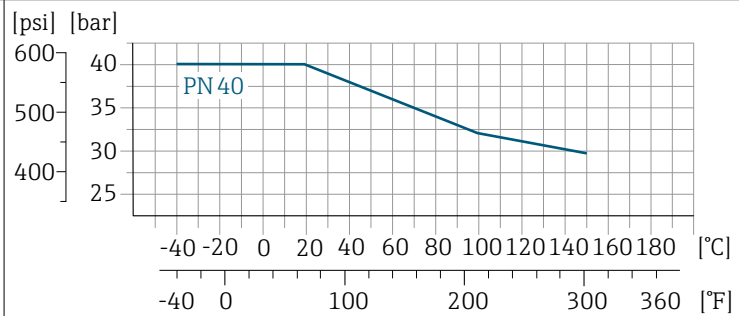

A0028928-EN

Fixed flange according to ASME B16.5

Stainless steel

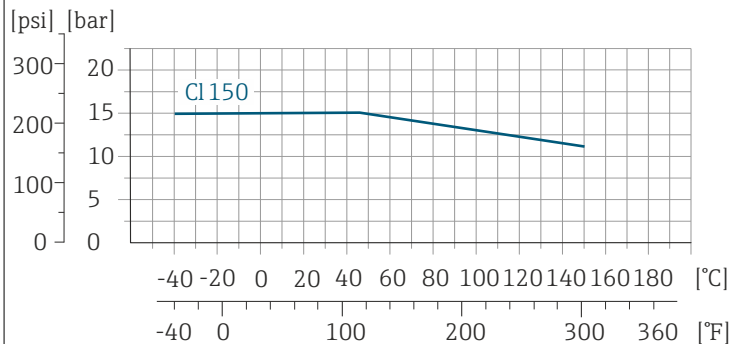

A0028936-EN

Fixed flange according to JIS B2220

Stainless steel

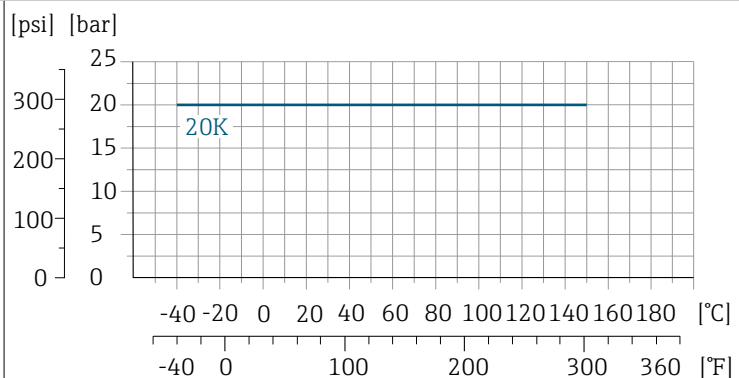

A0028938-EN

**Thread according to ISO 228
Welding socket according to ISO 2037**

Stainless steel

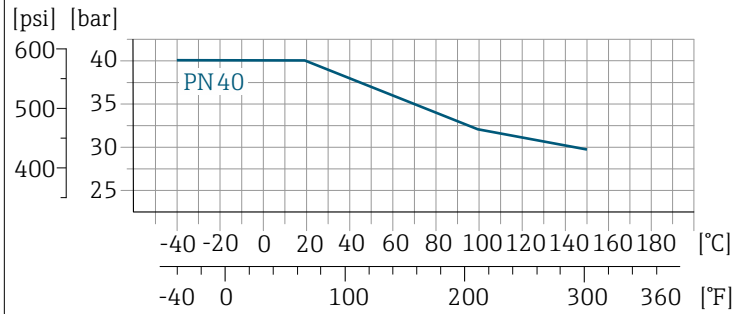

A0028928-EN

Process connections with aseptic gasket seal, DN 2 to 25 (1/12 to 1")

**Welding socket according to EN 10357 (DIN 11850)
Thread according to DIN 11851 SC
Thread according to DIN 11864-1
Flange DIN 11864-2 Form**

Stainless steel

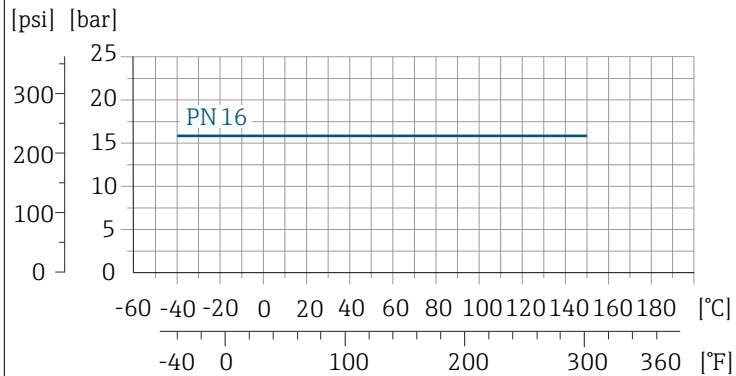

A0028940-EN

Process connections with aseptic gasket seal, DN 40 to 150 (1 1/2 to 6")

**Welding socket according to ASME BPE A0028942-DE
Welding socket according to EN 10357 (DIN 11850)
Welding socket according to ISO 2037
Thread according to DIN 11851 SC**

Stainless steel

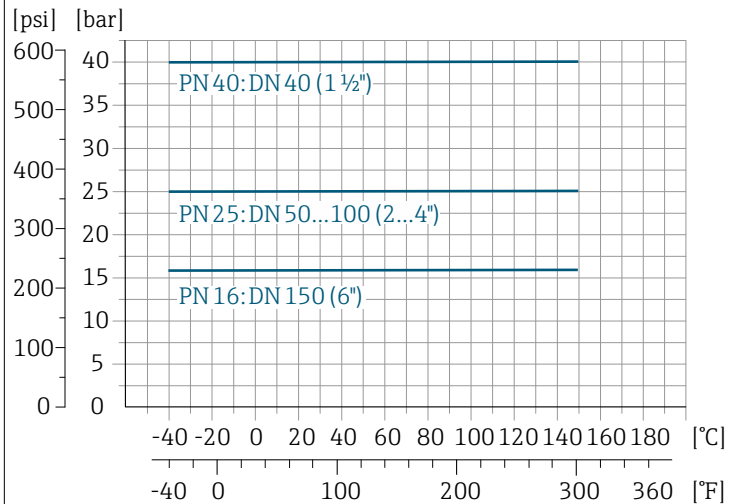

A0028942-EN

**Flange DIN 11864-2 Form A, flange with notch
Thread according to DIN 11864-1**

Stainless steel

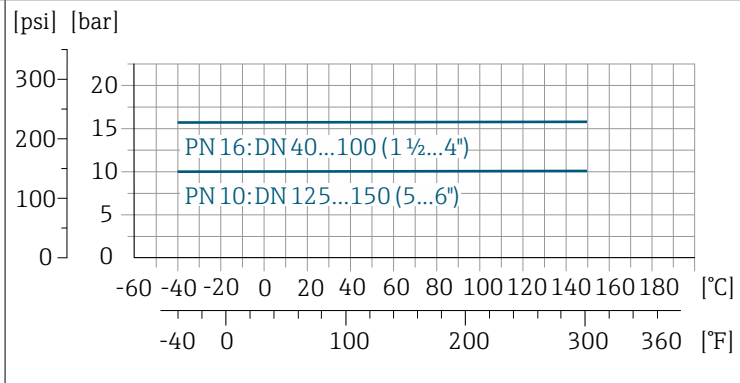

Tri-clamp

Stainless steel

The clamp connections are suitable up to a maximum pressure of 16 bar (232 psi). Please observe the operating limits of the clamp and seal used as they can be over 16 bar (232 psi). The clamp and seal are not included in the scope of supply.

Pressure tightness

Limit values for the absolute pressure depending on the liner and medium temperature

PFA	Nominal diameter		Absolute pressure in [mbar] ([psi])				
	[mm]	[in]	+25 °C (+77 °F)	+80 °C (+176 °F)	+100 °C (+212 °F)	+130 °C (+266 °F)	+150 °C (+302 °F)
	2 to 150	1/12 to 6	0 (0)	0 (0)	0 (0)	0 (0)	0 (0)

Pressure loss

- No pressure loss: as of DN 8 (5/16"), with transmitter installed in a pipe with the same nominal diameter.
- Pressure loss information when adapters are used → *Adapters*, 29

Mechanical construction

Weight

All values refer to devices with flanges with a standard pressure rating. Weight data are guideline values. The weight may be lower than indicated depending on the pressure rating and design.

Transmitter remote version

Aluminum: 2.4 kg (5.3 lbs)

Sensor remote version

Aluminum sensor connection housing: see the information in the following table.

Nominal diameter		Weight	
[mm]	[in]	[kg]	[lbs]
2	1/12	4.7	10.4
4	5/32	4.7	10.4
8	5/16	4.7	10.4
15	½	4.6	10.1
25	1	5.5	12.1
40	1 ½	6.8	15.0
50	2	7.3	16.1
65	–	8.1	17.9
80	3	8.7	19.2
100	4	10.0	22.1
125	5	15.4	34.0
150	6	17.8	39.3

Measuring pipe specification

Nominal diameter		Pressure rating ¹⁾ EN (DIN) [bar]	Process connection internal diameter	
[mm]	[in]		PFA	
[mm]	[in]		[mm]	[in]
2	1/12	PN 16/40	2.25	0.09
4	5/32	PN 16/40	4.5	0.18
8	5/16	PN 16/40	9.0	0.35
15	½	PN 16/40	16.0	0.63
–	1	PN 16/40	22.6	0.89
25	–	PN 16/40	26.0	1.02
40	1 ½	PN 16/25/40	35.3	1.39
50	2	PN 16/25	48.1	1.89
65	–	PN 16/25	59.9	2.36
80	3	PN 16/25	72.6	2.86
100	4	PN 16/25	97.5	3.84

Nominal diameter		Pressure rating ¹⁾ EN (DIN) [bar]	Process connection internal diameter	
[mm]	[in]		PFA [mm]	[in]
125	5	PN 10/16	120.0	4.72
150	6	PN 10/16	146.5	5.77

1) Depending on process connection and seals used

Materials

Transmitter housing

Order code for "Housing"	Option A: aluminum, AlSi10Mg, coated
Window material	Glass

Sensor connection housing

Stainless steel 1.4301 (304)

Cable glands and entries

Cable gland M20×1.5	Plastic
Adapter for cable entry with female thread G ½" or NPT ½"	Nickel-plated brass

Connecting cable for remote version

Electrode and coil current cable:
PVC cable with copper shield

Sensor housing

Stainless steel: 1.4301 (304)

Measuring pipes

Stainless steel: 1.4301 (304)

Liner

PFA (USP Class VI, FDA 21 CFR 177.2600)

Electrodes

Stainless steel: 1.4435 (316L)

Seals

- O-ring seal, DN 2 to 25 (1/12 to 1"): EPDM, FKM, Kalrez
- Aseptic (hygienic design) gasket seal, DN 2 to 150 (1/12 to 6"): EPDM, FKM, VMQ (silicone)

Process connections

- Stainless steel, 1.4404 (F316L)
- PVDF
- PVC adhesive sleeve

Wall mounting kit

Stainless steel 1.4301 (304)
Does not meet the hygienic design installation guidelines.

Spacer

Stainless steel 1.4435 (F316L)

Accessories

Protective cover	Stainless steel, 1.4404 (316L)
Pipe mounting set	Stainless steel 1.4301 (304)
Wall mounting kit	Stainless steel 1.4301 (304) Does not meet the hygienic design installation guidelines.

Fitted electrodes

Standard electrodes:

- Measuring electrodes
- Empty pipe detection electrode (only DN 15 to 150 (½ to 6"))

Surface roughness

Data relate to surfaces in contact with the medium.

Stainless steel electrodes, 1.4435 (316L); Alloy C22, 2.4602 (UNS N06022);
platinum; tantalum:

≤ 0.3 to 0.5 μm (11.8 to 19.7 μin)

Liner with PFA:

≤ 0.4 μm (15.7 μin)

Stainless steel process connections:

- With O-ring seal: Ra ≤ 1.6 μm (63 μin)
- With aseptic seal: R_{amax} = 0.76 μm (30 μin),

Local display

Operating concept

Operation method	<ul style="list-style-type: none"> Operation via local display with touch screen. Operation via SmartBlue App.
Menu structure	<p>Operator-oriented menu structure for user-specific tasks:</p> <ul style="list-style-type: none"> Diagnostics Application System Guidance Language
Commissioning	<ul style="list-style-type: none"> Commissioning via a guided menu (Commissioning wizard). Menu guidance with interactive help function for individual parameters.
Reliable operation	<ul style="list-style-type: none"> Operation in local language. Uniform operating philosophy in device and in the SmartBlue App. Write protection When electronics modules are replaced: configurations are transferred using the T-DAT Backup device memory. The device memory contains process data, device data and the event logbook. No reconfiguration is necessary.
Diagnostic behavior	<p>Efficient diagnostic behavior increases measurement availability:</p> <ul style="list-style-type: none"> Open troubleshooting measures via local display and SmartBlue App. Diverse simulation options. Logbook of events that have occurred.

Operating options

Local display

Display elements:

- LCD touch screen
- Depends on the orientation, automatic alignment of local display.
- Configuration of display format for measured variables and status variables.

Operating elements:

- Touch screen
- Local display can also be accessed in the hazardous area.

A0042957

SmartBlue App	<ul style="list-style-type: none"> The SmartBlue App allows the user to put devices into operation and operate them. Based on Bluetooth. No separate driver required. Available for mobile handheld terminals, tablets and smartphones. Suitable for convenient and secure access to devices in hard-to-reach locations or in hazardous areas. Can be used within a 20 m (65.6 ft) radius of the device. Encrypted and secure data transmission. No data loss during commissioning and maintenance. Diagnostic information and process information in real time.
---------------	---

Operating tools

Operating tools	Operating unit	Interface	Additional information
DeviceCare SFE100	<ul style="list-style-type: none"> ▪ Notebook ▪ PC ▪ Tablet with Microsoft Windows system 	<ul style="list-style-type: none"> ▪ CDI service interface ▪ Fieldbus protocol 	Innovation brochure IN01047S
FieldCare SFE500	<ul style="list-style-type: none"> ▪ Notebook ▪ PC ▪ Tablet with Microsoft Windows system 	<ul style="list-style-type: none"> ▪ CDI service interface ▪ Fieldbus protocol 	Operating Instructions BA00027S and BA00059S
SmartBlue App	<ul style="list-style-type: none"> ▪ Devices with iOS: iOS9.0 or higher ▪ Devices with Android: Android 4.4 KitKat or higher 	Bluetooth	Endress+HauserSmartBlue App: <ul style="list-style-type: none"> ▪ Google Playstore (Android) ▪ iTunes Apple Shop (iOS devices)
Device Xpert	Field Xpert SFX 100/350/370	HART fieldbus protocol	Operating Instructions BA01202S

Certificates and approvals

Non-Ex approval

- cCSAus
- EAC

Pressure Equipment Directive

- CRN
- PED Cat. II/III

Pharmaceutical compatibility

- FDA
- USP Class VI
- TSE/BSE Certificate of Suitability
- cGMP

HART certification

The device is certified and registered by the FieldComm Group. The measuring system meets all the requirements of the following specifications:

- Certified according to HART 7
- The device can also be operated with certified devices of other manufacturers (interoperability).

Radio approval

The device has radio approvals.

Other standards and guidelines

- IEC/EN 60529
Degrees of protection provided by enclosures (IP code)
- IEC/EN 60068-2-6
Environmental influences: Test procedure - Test Fc: vibrate (sinusoidal)
- IEC/EN 60068-2-31
Environmental influences: Test procedure - Test Ec: shocks due to rough handling, primarily for devices.
- IEC/EN 61010-1
Safety requirements for electrical equipment for measurement, control and laboratory use - general requirements.
- CAN/CSA-C22.2 No. 61010-1-12
Safety Requirements for Electrical Equipment for Measurement, Control and Laboratory Use - Part 1 General Requirements.
- IEC/EN 61326
Emission in accordance with Class A requirements. Electromagnetic compatibility (EMC requirements)
- ANSI/ISA-61010-1 (82.02.01)
Safety Requirements for Electrical Equipment for Measurement, Control and Laboratory Use - Part 1 General Requirements.
- NAMUR NE 21
Electromagnetic compatibility (EMC) of industrial process and laboratory control equipment.
- NAMUR NE 32
Data retention in the event of a power failure in field and control instruments with microprocessors.
- NAMUR NE 43
Standardization of the signal level for the breakdown information of digital transmitters with analog output signal.
- NAMUR NE 53
Software of field devices and signal-processing devices with digital electronics.
- NAMUR NE 105
Specifications for integrating fieldbus devices in engineering tools for field devices.
- NAMUR NE 107
Self-monitoring and diagnosis of field devices.
- NAMUR NE 131
Requirements for field devices for standard applications.
- ETSI EN 300 328
Guidelines for 2.4 GHz radio components
- EN 301489
Electromagnetic compatibility and radio spectrum matters (ERM).

Application packages

Use

Many different application packages are available to enhance the functionality of the device. Such packages might be needed to address safety aspects or specific application requirements.

The application packages can be ordered with the device or subsequently from Endress+Hauser. Detailed information on the relevant order code is available from your local Endress+Hauser sales organization or on the product page of the Endress+Hauser website: www.endress.com.

Heartbeat Verification + Monitoring

Heartbeat Verification

Availability depends on the product structure.

Meets the requirement for traceable verification to DIN ISO 9001:2008 Chapter 7.6 a) "Control of monitoring and measuring equipment":

- Functional testing in the installed state without interrupting the process.
- Traceable verification results on request, including a report.
- Simple testing process with local operation or other operating interfaces.
- Clear measuring point assessment (pass/fail) with high test coverage within the framework of manufacturer specifications.
- Extension of calibration intervals according to operator's risk assessment.

Heartbeat Monitoring

Availability depends on the product structure.

Heartbeat Monitoring continuously supplies data, which are characteristic of the measuring principle, to an external condition monitoring system for the purpose of preventive maintenance or process analysis. These data enable the operator to:

- Draw conclusions - using these data and other information - about the impact the process influences, e.g. corrosion, abrasion, formation of buildup, have on the measuring performance over time.
- Schedule servicing in time.
- Monitor the process quality or product quality, e.g. gas pockets.

14 Dimensions in SI units

Compact version	114
Order code for "Housing", option A "Aluminum, coated"	114
Remote version	115
Transmitter remote version	115
Sensor remote version	116
Sensor flange connection	117
Flange connections	119
Flange DIN 11864-2 Form A, female	119
Flange DIN 11864-2 Form A, flange with notch	119
Flange in accordance with EN 1092-1 (DIN 2501 / DIN 2512N); PN 40	120
Flange according to ASME B16.5, Class 150	120
Flange according to JIS B2220, 20K	121
Clamp connections	122
Tri-Clamp	122
Welding socket	123
Welding socket according to EN 10357	123
Welding socket according to ISO 2037	123
Welding socket according to ASME BPE	124
Couplings	125
Thread according to DIN 11851 SC	125
Thread according to DIN 11864-1, Form A	126
Male thread according to ISO 228/DIN 2999	127
Mounting kit	128
Wall mounting kit	128
Accessories	129
Grounding rings	129
Spacer	129
Male thread with O-ring seal	130
Female thread with O-ring seal	130
Tri-Clamp	131
Protective cover	131

Compact version

Order code for "Housing", option A "Aluminum, coated"

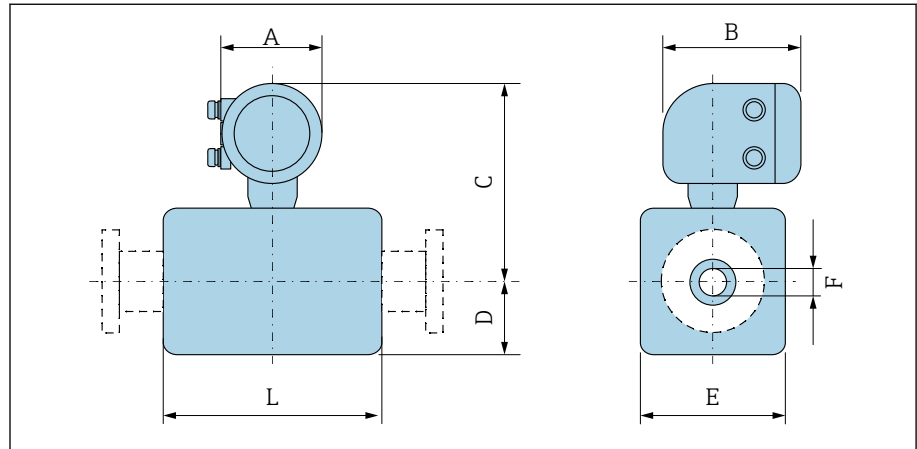

A0043172

DN		A ¹⁾	B	C	D	E	F	L ²⁾
[mm]	[in]	[mm]	[mm]	[mm]	[mm]	[mm]	[mm]	[mm]
2	1/12	139	178	235	48	43	2.25	86
4	1/32	139	178	235	48	43	4.5	86
8	5/16	139	178	235	48	43	9	86
15	1/2	139	178	235	48	43	16	86
-	1	139	178	239	52	56	22.6	86
25	-	139	178	239	52	56	26.0	86
40	1 1/2	139	178	242	54	107	34.8	140
50	2	139	178	249	60	120	47.5	140
65	-	139	178	256	68	135	60.2	140
80	3	139	178	263	74	148	72.9	140
100	4	139	178	276	87	174	97.4	140
125	-	139	178	292	103	206	120.0	200
150	6	139	178	306	117	234	146.9	200

1) Depending on the cable gland used; values up to + 30 mm

2) Total length depends on the process connections.

Remote version

Transmitter remote version

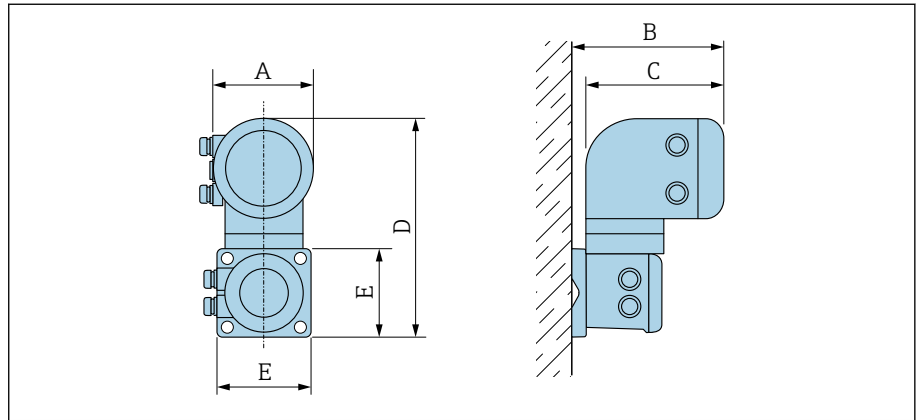

A0042715

Order code for "Housing"	A ¹⁾ [mm]	B [mm]	C [mm]	D [mm]	E [mm]
Option P "Remote, aluminum, coated"	139	185	178	309	130

1) Depending on the cable entry used: values up to + 30 mm

Sensor remote version

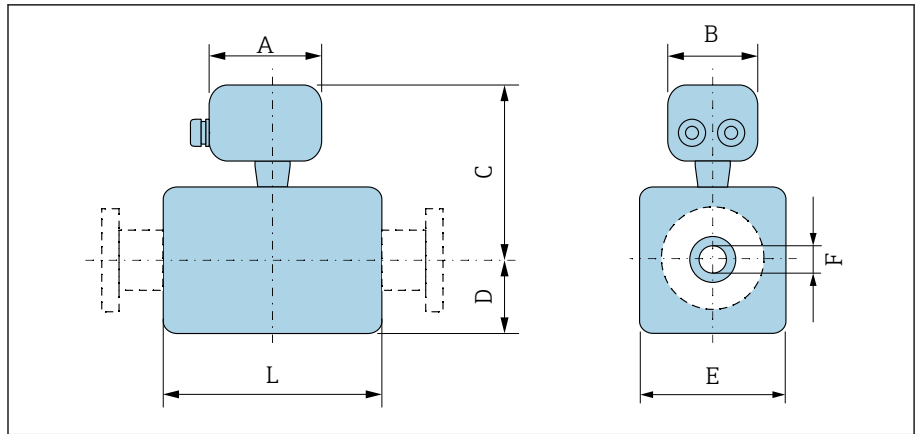

DN		A ¹⁾	B	C	D	E	F	L ²⁾
[mm]	[in]	[mm]	[mm]	[mm]	[mm]	[mm]	[mm]	[mm]
2	1/12	183	207	129	55	43	2.25	86
4	1/32	183	207	129	55	43	4.5	86
8	5/16	183	207	129	55	43	9	86
15	1/2	183	207	129	55	43	16	86
-	1	183	207	133	55	56	22.6	86
25	-	183	207	133	55	56	26.0	86
40	1 1/2	183	207	136	54	107	34.8	140
50	2	183	207	143	60	120	47.5	140
65	-	183	207	150	67	135	60.2	140
80	3	183	207	157	74	148	72.9	140
100	4	183	207	170	87	174	97.4	140
125	-	183	207	186	103	206	120.0	200
150	6	183	207	200	117	234	146.9	200

1) Depending on the cable gland used: values up to + 30 mm

2) Total length depends on the process connections.

Sensor flange connection

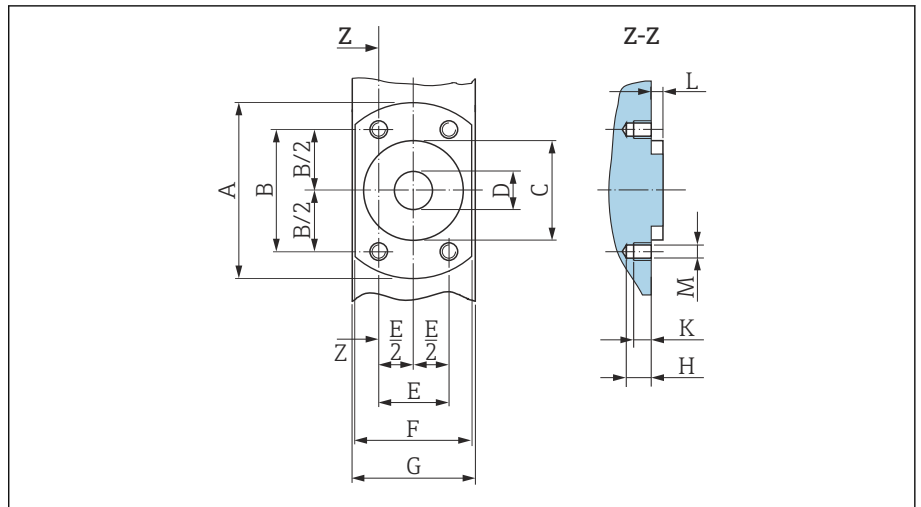

A0017657

10 Front view without process connections

[mm]	DN	[mm]	[mm]	[mm]	[mm]	[mm]	[mm]	[mm]	[mm]	[mm]	[mm]	[mm]	[mm]
	[in]												
2	1/12	62	41.6	34	9	24	42	43	8.5	6	4	M6	
4	1/32	62	41.6	34	9	24	42	43	8.5	6	4	M6	
8	5/16	62	41.6	34	9	24	42	43	8.5	6	4	M6	
15	1/2	62	41.6	34	16	24	42	43	8.5	6	4	M6	
25	-	72	50.2	44	26	29	55	56	8.5	6	4	M6	

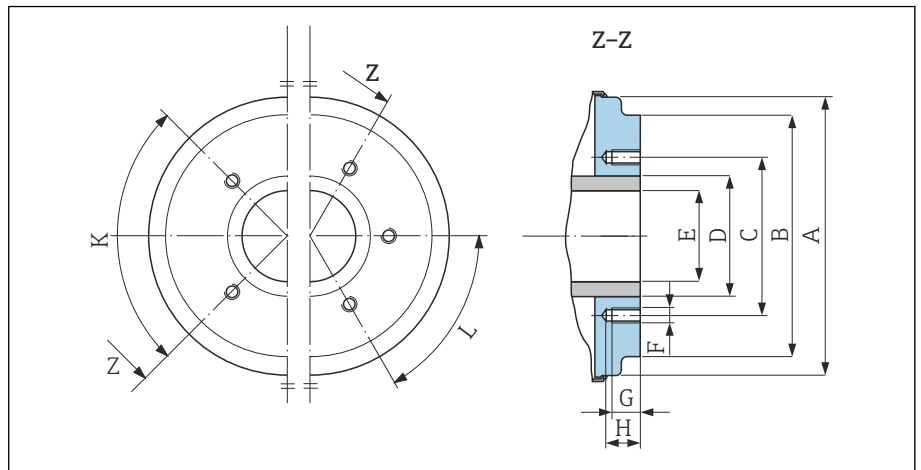

A0005528

11 Front view without process connections

[mm]	DN	[mm]	[mm]	[mm]	[mm]	[mm]	[mm]	[mm]	[mm]	[mm]	[mm]	Tapped holes
	[in]											
40	1 1/2	99.7	85.8	71.0	48.3	34.8	M8	12	17	4	-	
50	2	112.7	98.8	83.5	60.3	47.5	M8	12	17	4	-	
65	-	127.7	114.8	100.0	76.1	60.2	M8	12	17	-	6	

DN		A	B	C	D	E	F	G	H	K	L
[mm]	[in]	[mm]	[mm]	[mm]	[mm]	[mm]	[mm]	[mm]	[mm]	90° ±0.5°	60° ±0.5°
		Tapped holes									
80	3	140.7	133.5	114.0	88.9	72.9	M8	12	17	-	6
100	4	166.7	159.5	141.0	114.3	97.4	M8	12	17	-	6
125	-	198.7	191.5	171.0	139.7	120.0	M10	15	20	-	6
150	6	226.7	219.5	200.0	168.3	146.9	M10	15	20	-	6

Flange connections

Flange DIN 11864-2 Form A, female

Stainless steel: order code for "Process connection", option DQS

Suitable for pipe as per EN 10357 series A, female

DN 2 to 8 with DN 10 flanges as standard

Surface roughness: $Ra_{max} = 0.76 \mu m$

i Please note the internal diameters of the measuring pipe and process connection (E) when cleaning with pigs.

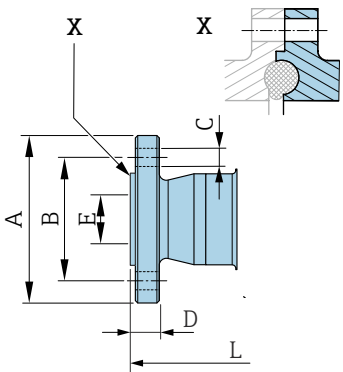

DN [mm]	Pipe [mm]	A [mm]	B [mm]	C [mm]	D [mm]	E [mm]	L [mm]
2 to 8	13 × 1.5 (DN 10)	54	37	4 × Ø9	10	10	183
15	19 × 1.5 (DN 15)	59	42	4 × Ø9	10	16	183
25	29 × 1.5 (DN 25)	70	53	4 × Ø9	10	26	183

A0043232

Flange DIN 11864-2 Form A, flange with notch

Stainless steel: order code for "Process connection", option DRS

Suitable for pipe as per EN 10357 series A, flange with notch

Surface roughness: $Ra_{max} = 0.76 \mu m$

i Please note the internal diameters of the measuring pipe and process connection (E) when cleaning with pigs.

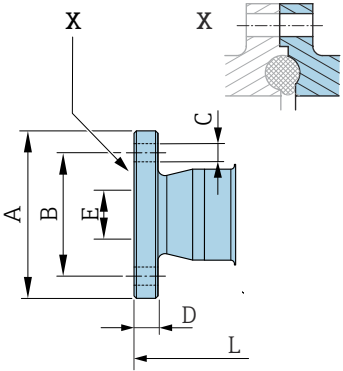

DN [mm]	Pipe [mm]	A [mm]	B [mm]	C [mm]	D [mm]	E [mm]	L [mm]
40	41 × 1.5	82	65	4 × Ø9	10	38	246
50	53 × 1.5	94	77	4 × Ø9	10	50	246
65	70 × 2	113	95	8 × Ø9	10	66	246
80	85 × 2	133	112	8 × Ø11	10	81	270
100	104 × 2	159	137	8 × Ø11	10	100	278
125	129 × 2	183	161	8 × Ø11	10	125	362
150	154 × 2	213	188	8 × Ø14	10	150	362

A0042819

**Flange in accordance with EN 1092-1 (DIN 2501 / DIN 2512N):
PN 40**

Stainless steel: order code for "Process connection", option D5S

Surface roughness: EN 1092-1 Form B1 (DIN 2526 Form C), $R_a \leq 1.6 \mu\text{m}$

DN 2 to 8 with DN 15 flanges as standard

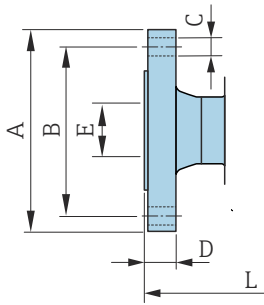

A0042813

DN [mm]	A [mm]	B [mm]	C [mm]	D [mm]	E [mm]	L [mm]
2 to 8	95	65	4 × Ø14	16	17.3	198.4
15	95	65	4 × Ø14	16	17.3	198.4
25	115	85	4 × Ø14	18	28.5	198.4

Flange according to ASME B16.5, Class 150

Stainless steel: order code for "Process connection", option A1S

Surface roughness: $R_a \leq 1.6 \mu\text{m}$

DN 2 to 8 with DN 15 flanges as standard

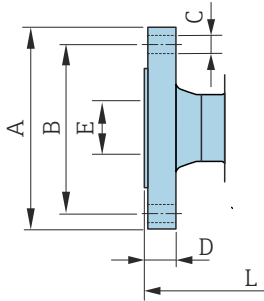

A0042813

DN [mm]	A [mm]	B [mm]	C [mm]	D [mm]	E [mm]	L [mm]
2 to 8	90	60.3	4 × Ø15.7	11.2	15.7	218
15	90	60.3	4 × Ø15.7	11.2	15.7	218
25	110	79.4	4 × Ø15.7	14.2	26.7	230

Flange according to JIS B2220, 20K

Stainless steel: order code for "Process connection", option N4S

Surface roughness: $R_a \leq 1.6 \mu\text{m}$

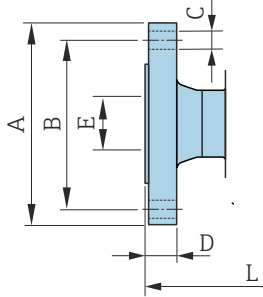

A0042813

DN [mm]	A [mm]	B [mm]	C [mm]	D [mm]	E [mm]	L [mm]
2 to 8	95	70	4 × Ø15	14	15	220
15	95	70	4 × Ø15	14	15	220
25	125	90	4 × Ø19	16	25	220

Clamp connections

Tri-Clamp

1.4404/316L: order code for "Process connection", option FAS

Suitable for pipe as per ASME BPE (DIN 11866 series C)

Surface roughness: $Ra_{max} = 0.76 \mu m$

i Please note the internal diameters of the measuring pipe and process connection (B) when cleaning with pigs.

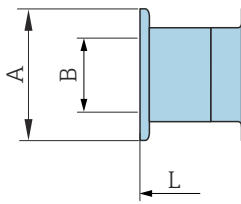

A0043179

DN [mm]	Pipe [mm]	A [mm]	B [mm]	L [mm]
2 to 8	12.7 × 1.65	25	9.4	143
15	19.1 × 1.65	25	15.8	143
25	25.4 × 1.65	50.4	22.1	143
40	38.1 × 1.65	50.4	34.8	220
50	50.8 × 1.65	63.9	47.5	220
65	63.5 × 1.65	77.4	60.2	220
80	76.2 × 1.65	90.9	72.9	220
100	101.6 × 2.11	118.9	97.4	220
150	152.4 × 2.77	166.9	146.9	300

Welding socket

Welding socket according to EN 10357

1.4404/316L: order code for "Process connection", option DAS

Suitable for pipe EN 10357 series A

Surface roughness: $Ra_{max} = 0.76 \mu\text{m}$

i Please note the internal diameters of the measuring pipe and process connection (B) when cleaning with pigs.

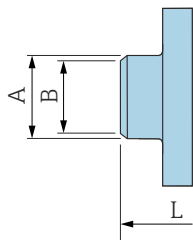

A0043180

DN [mm]	Pipe [mm]	A [mm]	B [mm]	L [mm]
2 to 8	13 × 1.5	13	10	132.6
15	19 × 1.5	19	16	132.6
25	29 × 1.5	29	26	132.6
40	41 × 1.5	41	38	220
50	53 × 1.5	53	50	220
65	70 × 2	70	66	220
80	85 × 2	85	81	220
100	104 × 2	104	100	220
125	129 × 2	129	125	300
150	154 × 2	154	150	300

Welding socket according to ISO 2037

1.4404/316L: order code for "Process connection", option IAS

Suitable for pipe ISO 2037

Surface roughness: $Ra_{max} = 0.76 \mu\text{m}$

i Please note the internal diameters of the measuring pipe and process connection (dimension B) when cleaning with pigs.

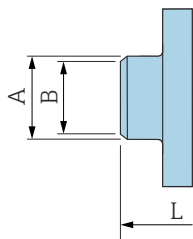

A0043180

DN [mm]	Pipe [mm]	A [mm]	B [mm]	L [mm]
2 to 8	12.7 × 1.65	12	10	118.2
15	19.05 × 1.65	18	16	118.2
25	25.4 × 1.60	25	22.6	118.2
40	38 × 1.2	38	35.6	220
50	51 × 1.2	51	48.6	220
65	63.5 × 1.6	63.5	60.3	220
80	76.1 × 1.6	76.1	72.9	220
100	101.6 × 2	101.6	97.6	220
125	139.7 × 2	139.7	135.7	380
150	168.3 × 2.6	168.3	163.1	380

Welding socket according to ASME BPE

1.4404/316L: order code for "Process connection", option AAS

Suitable for pipe as per ASME BPE (DIN 11866 series C)

Surface roughness: $Ra_{max} = 0.76 \mu m$

i Please note the internal diameters of the measuring pipe and process connection (dimension B) when cleaning with pigs.

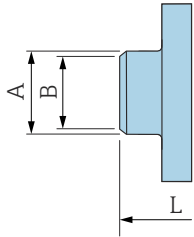

A0043180

DN [mm]	Pipe [mm]	A [mm]	B [mm]	L [mm]
2 to 8	12.7 × 1.65	12.7	9	118.2
15	19.1 × 1.65	19.1	16	118.2
25	25.4 × 1.65	25.4	22.6	118.2
40	38.1 × 1.65	38.1	34.8	220
50	50.8 × 1.65	50.8	47.5	220
65	63.5 × 1.65	63.5	60.2	220
80	76.2 × 1.65	76.2	72.9	220
100	101.6 × 1.65	101.6	97.4	220
150	152.4 × 2.77	152.4	146.9	300

Couplings

Thread according to DIN 11851 SC

1.4404/316L: order code for "Process connection", option DCS

Suitable for pipe EN 10357 series B (DN 2 to 25)

Surface roughness: $Ra_{max} = 0.76 \mu m$

i Please note the internal diameters of the measuring pipe and process connection (B) when cleaning with pigs.

DN [mm]	Pipe [mm]	A [mm]	B [mm]	L [mm]
2 to 8	12 × 1 (DN 10)	Rd 28 × 1/8	10	174
15	18 × 1.5 (ODT 3/4")	Rd 34 × 1/8	16	174
25	28 × 1 or 28 × 1.5	Rd 52 × 1/6	26	190

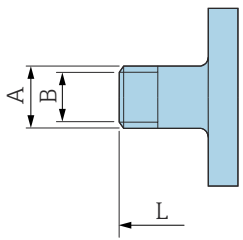

A0043253

1.4404/316L: order code for "Process connection", option DCS

Suitable for pipe EN 10357 series A (DN 40 to 150)

Surface roughness: $Ra_{max} = 0.76 \mu m$

i Please note the internal diameters of the measuring pipe and process connection (B) when cleaning with pigs.

DN [mm]	Pipe [mm]	A [mm]	B [mm]	L [mm]
40	41 × 1.5	Rd 65 × 1/6	38	260
50	53 × 1.5	Rd 78 × 1/6	50	260
65	70 × 2	Rd 95 × 1/6	66	270
80	85 × 2	Rd 110 × 1/4	81	280
100	104 × 2	Rd 130 × 1/4	100	290
125	129 × 2	Rd 160 × 1/4	125	380
150	154 × 2	Rd 160 × 1/4	150	390

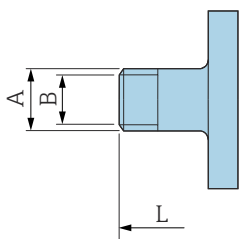

A0043253

Thread according to DIN 11864-1, Form A

1.4404/316L: order code for "Process connection", option DDS

Suitable for pipe EN 10357 series A

Surface roughness: $Ra_{max} = 0.76 \mu\text{m}$

i Please note the internal diameters of the measuring pipe and process connection (B) when cleaning with pigs.

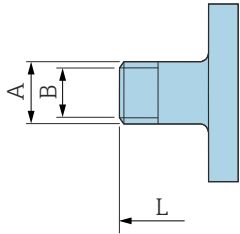

A0043253

DN [mm]	Pipe [mm]	A [mm]	B [mm]	L [mm]
2 to 8	Pipe 13 × 1.5 (DN 10)	Rd 28 × 1/8	10	170
15	Pipe 19 × 1.5	Rd 34 × 1/8	16	170
25	Pipe 29 × 1.5	Rd 52 × 1/6	26	184
40	41 × 1.5	Rd 65 × 1/6	38	256
50	53 × 1.5	Rd 78 × 1/6	50	256
65	70 × 2	Rd 95 × 1/6	66	266
80	85 × 2	Rd 110 × 1/4	81	276
100	104 × 2	Rd 130 × 1/4	100	286

Male thread according to ISO 228/DIN 2999

1.4404/316L: order code for "Process connection", option I2S

Suitable for female thread ISO 228/DIN 2999

Surface roughness: $R_a \leq 1.6 \mu\text{m}$

DN [mm]	Pipe [mm]	A [mm]	B [mm]	L [mm]
2 to 8	R $\frac{3}{8}$	R $10.1 \times \frac{3}{8}$	10	166
15	R $\frac{1}{2}$	R $13.2 \times \frac{1}{2}$	16	166
25	R 1	R 16.5×1	25	170

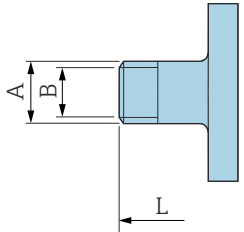

A0043253

Mounting kit

Wall mounting kit

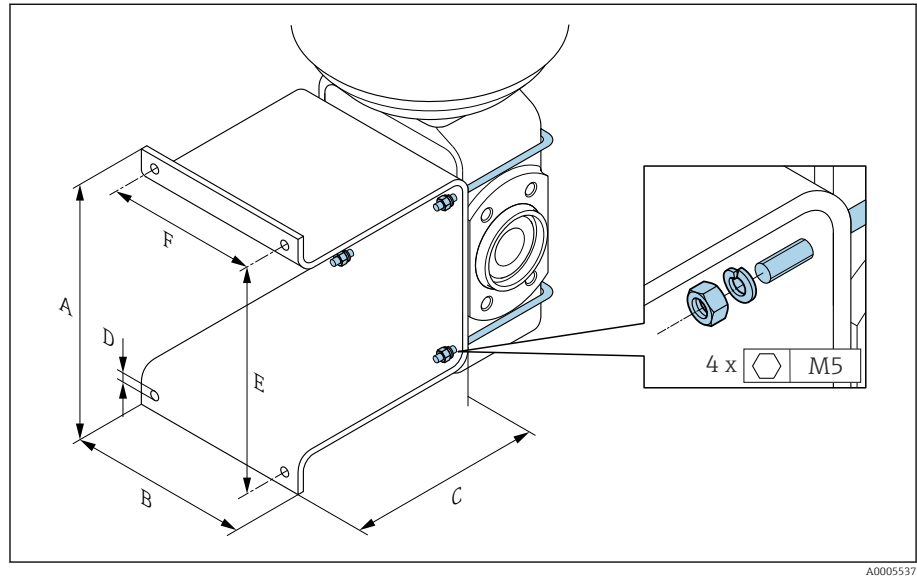

A	B	C	Ø D	E	F
[mm]	[mm]	[mm]	[mm]	[mm]	[mm]
137	110	120	7	125	88

Accessories

Grounding rings

Order code: DK5HR-****

1.4435 (316L), Alloy C22, tantalum

For lap joint flange made of PVDF and PVC adhesive sleeve

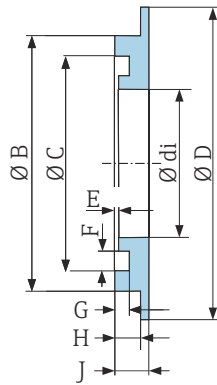

A0017673

DN [mm]	di [mm]	B [mm]	C [mm]	D [mm]	D [mm]	E [mm]	G [mm]	H [mm]	J [mm]
2 to 8	9	22	17.6	33.9	0.5	3.5	1.9	3.4	4.5
15	16	29	24.6	33.9	0.5	3.5	1.9	3.4	4.5
25	26	39	34.6	43.9	0.5	3.5	1.9	3.4	4.5

Spacer

Order code: DK5HB-****

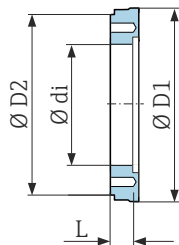

A0017294

DN [mm]	di [mm]	D1 [mm]	D2 [mm]	L [mm]
80	72.9	140.7	141	30
100	97.4	166.7	162	30

Male thread with O-ring seal

Order code: DKH**^{-GD}**

1.4404/316L

Suitable for NPT female thread

Surface roughness: Ra ≤ 1.6 μm

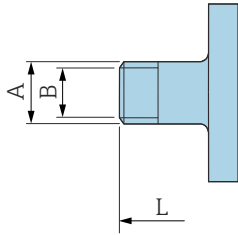

A0043253

DN [mm]	Thread [mm]	A [mm]	B [mm]	L [mm]
2 to 8	NPT 3/8	R 15.5 × 3/8	10	186
15	NPT 1/2	R 20 × 1/2	16	186
25	NPT 1	R 25 × 1	25	196

Female thread with O-ring seal

Order code: DKH**^{-GC}**

1.4404/316L

Suitable for NPT male thread

Surface roughness: Ra ≤ 1.6 μm

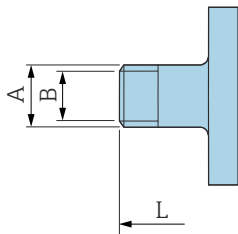

A0043253

DN [mm]	Thread [mm]	A [mm]	B [mm]	L [mm]
2 to 8	NPT 3/8	R 13 × 3/8	8.9	176
15	NPT 1/2	R 14 × 1/2	16	176
25	NPT 1	R 17 × 1	27.2	188

Tri-Clamp

Order code: DKH**-HF**

1.4404 (316L)

Suitable for pipe in accordance with ASME BPE (reduction)

Surface roughness: $Ra_{max} = 0.76 \mu m$

i Please note the internal diameters of the measuring pipe and process connection (B) when cleaning with pigs.

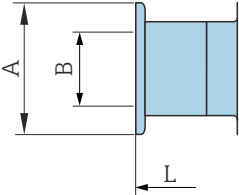
	DN [mm]	Pipe [mm]	A [mm]	B [mm]	L [mm]
	15	Pipe ODT 1	50.4	22.1	143

A0043179

Protective cover

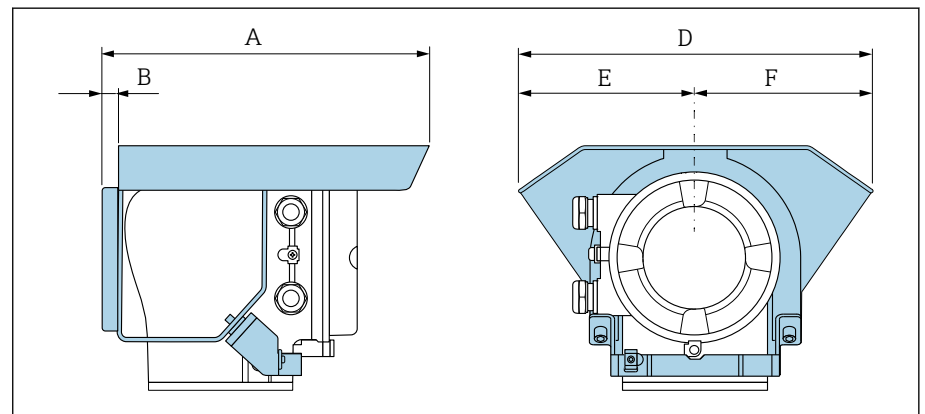

A0042332

A [mm]	B [mm]	D [mm]	E [mm]	F [mm]
257	12	280	140	140

15 Dimensions in US units

Compact version	134
Order code for "Housing", option A "Aluminum, coated"	134
Remote version	135
Transmitter remote version	135
Sensor remote version	136
Sensor flange connection	137
Flange connections	139
Flange according to ASME B16.5, Class 150	139
Clamp connections	139
Tri-Clamp	139
Welding socket	140
Welding socket according to ISO 2037	140
Welding socket according to ASME BPE	140
Mounting kits	141
Wall mounting kit	141
Accessories	142
Spacer	142
Clamp connections with aseptic gasket seal available for order	142
Threaded glands with O-ring seal available for order	143
Grounding rings	144
Protective cover	144

Compact version

Order code for "Housing", option A "Aluminum, coated"

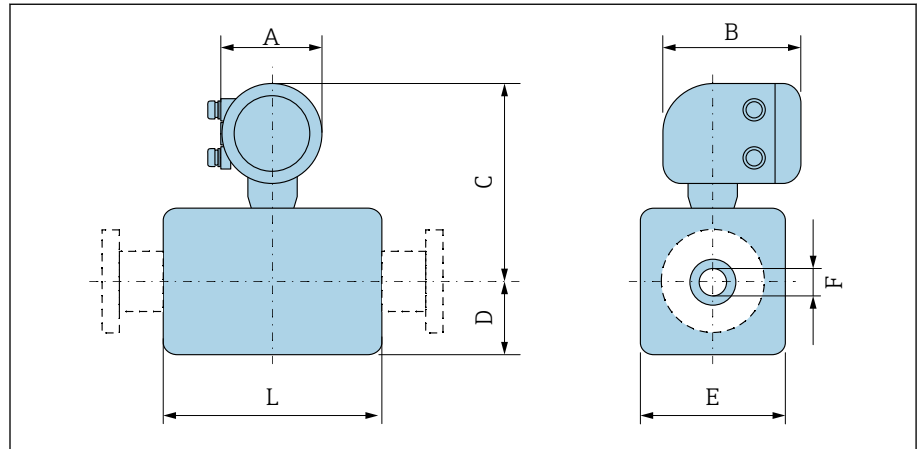

DN		A ¹⁾	B	C	D	E	F	L ²⁾
[mm]	[in]	[in]	[in]	[in]	[in]	[in]	[in]	[in]
2	1/12	5.47	7.01	9.25	1.89	1.69	0.089	3.39
4	1/32	5.47	7.01	9.25	1.89	1.69	0.18	3.39
8	5/16	5.47	7.01	9.25	1.89	1.69	0.35	3.39
15	1/2	5.47	7.01	9.25	1.89	1.69	0.63	3.39
-	1	5.47	7.01	9.41	2.05	2.2	0.89	3.39
25	-	5.47	7.01	9.41	2.05	2.2	1.02	3.39
40	1 1/2	5.47	7.01	9.53	2.13	4.21	1.37	5.51
50	2	5.47	7.01	9.8	2.36	4.72	1.87	5.51
65	-	5.47	7.01	10.08	2.68	5.31	2.37	5.51
80	3	5.47	7.01	10.35	2.91	5.83	2.87	5.51
100	4	5.47	7.01	10.87	3.43	6.85	3.83	5.51
125	-	5.47	7.01	11.5	4.06	8.11	4.72	7.87
150	6	5.47	7.01	12.05	4.61	9.21	5.78	7.87

- 1) Depending on the cable gland used; values up to +1.18 in
- 2) Total length depends on the process connections.

Remote version

Transmitter remote version

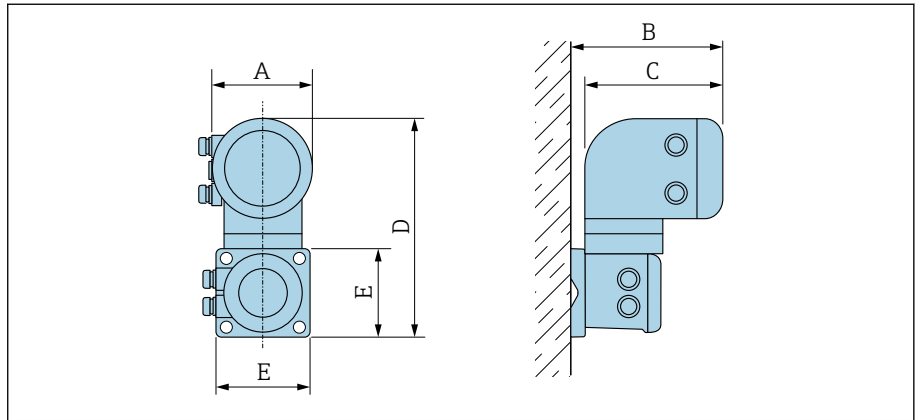

A0042715

Order code for "Housing"	A ¹⁾ [in]	B [in]	C [in]	D [in]	E [in]
Option P "Remote, aluminum, coated"	5.47	7.28	7.01	12.17	5.12

1) Depending on the cable entry used: values up to +1.18 in

Sensor remote version

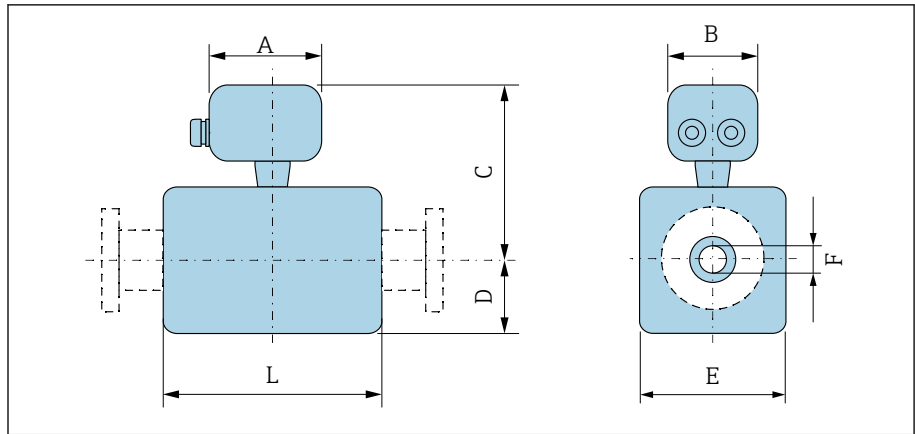

DN		A ¹⁾	B	C	D	E	F	L ²⁾
[mm]	[in]	[in]	[in]	[in]	[in]	[in]	[in]	[in]
2	1/12	7.2	8.15	5.08	2.17	1.69	0.089	3.39
4	1/32	7.2	8.15	5.08	2.17	1.69	0.18	3.39
8	5/16	7.2	8.15	5.08	2.17	1.69	0.35	3.39
15	1/2	7.2	8.15	5.08	2.17	1.69	0.63	3.39
-	1	7.2	8.15	5.24	2.17	2.2	0.89	3.39
25	-	7.2	8.15	5.24	2.17	2.2	1.02	3.39
40	1 1/2	7.2	8.15	5.35	2.13	4.21	1.37	5.51
50	2	7.2	8.15	5.63	2.36	4.72	1.87	5.51
65	-	7.2	8.15	5.91	2.64	5.31	2.37	5.51
80	3	7.2	8.15	6.18	2.91	5.83	2.87	5.51
100	4	7.2	8.15	6.69	3.43	6.85	3.83	5.51
125	-	7.2	8.15	7.32	4.06	8.11	4.72	7.87
150	6	7.2	8.15	7.87	4.61	9.21	5.78	7.87

- 1) Depending on the cable gland used: values up to +1.18 in
- 2) Total length depends on the process connections.

Sensor flange connection

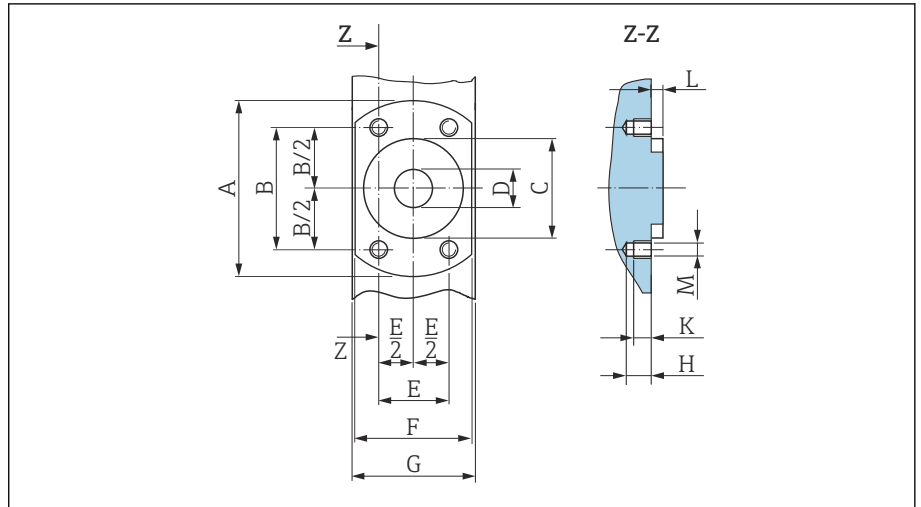

A0017657

12 Front view without process connections

[mm]	DN	[in]	A	B	C	D	E	F	G	H	K	L	M
	[in]		[in]	[in]	[in]	[in]	[in]	[in]	[in]	[in]	[in]	[in]	[mm]
2	1/12		2.44	1.64	1.34	0.35	0.94	1.65	1.69	0.33	0.24	0.16	M6
4	1/32		2.44	1.64	1.34	0.35	0.94	1.65	1.69	0.33	0.24	0.16	M6
8	5/16		2.44	1.64	1.34	0.35	0.94	1.65	1.69	0.33	0.24	0.16	M6
15	1/2		2.44	1.64	1.34	0.63	0.94	1.65	1.69	0.33	0.24	0.16	M6
25	-		2.83	1.98	1.73	1.02	1.14	2.17	2.2	0.33	0.24	0.16	M6

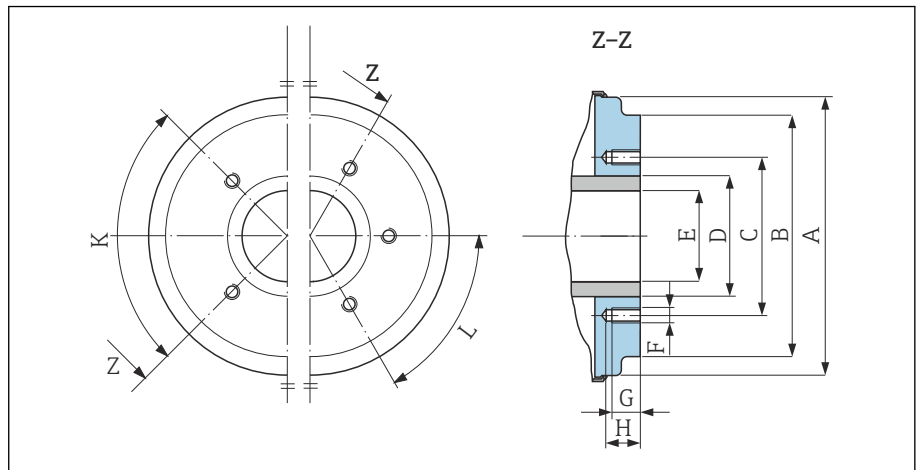

A0005528

13 Front view without process connections

[mm]	DN	[in]	A	B	C	D	E	F	G	H	K	L
	[in]		[in]	[in]	[in]	[in]	[in]	[mm]	[in]	[in]	90° ±0.5°	60° ±0.5°
												Tapped holes
40	1 1/2		3.93	3.38	2.8	1.9	1.37	M8	0.47	0.67	4	-
50	2		4.44	3.89	3.29	2.37	1.87	M8	0.47	0.67	4	-
65	-		5.03	4.52	3.94	3	2.37	M8	0.47	0.67	-	6

DN		A	B	C	D	E	F	G	H	K	L
[mm]	[in]	[in]	[in]	[in]	[in]	[in]	[mm]	[in]	[in]	90° ±0.5°	60° ±0.5°
		Tapped holes									
80	3	5.54	5.26	4.49	3.5	2.87	M8	0.47	0.67	-	6
100	4	6.56	6.28	5.55	4.5	3.83	M8	0.47	0.67	-	6
125	-	7.82	7.54	6.73	5.5	4.72	M10	0.59	0.79	-	6
150	6	8.93	8.64	7.87	6.63	5.78	M10	0.59	0.79	-	6

Flange connections

Flange according to ASME B16.5, Class 150

Stainless steel: order code for "Process connection", option A1S

Surface roughness: $R_a \leq 63 \mu\text{in}$

DN $\frac{1}{12}$ " to $\frac{5}{16}$ " with DN $\frac{1}{2}$ " flanges as standard

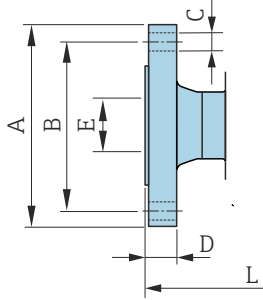

A0042813

DN [in]	A [in]	B [in]	C [in]	D [in]	E [in]	L [in]
$\frac{1}{12}$ to $\frac{5}{16}$	3.54	2.37	$4 \times \varnothing 0.62$	0.44	0.62	8.58
$\frac{1}{2}$	3.54	2.37	$4 \times \varnothing 0.62$	0.44	0.62	8.58
1	4.33	3.13	$4 \times \varnothing 0.62$	0.56	1.05	9.06

Clamp connections

Tri-Clamp

1.4404/316L: order code for "Process connection", option FAS

Suitable for pipe as per ASME BPE (DIN 11866 series C)

Surface roughness: $R_{a\text{max}} = 30 \mu\text{in}$

i Please note the internal diameters of the measuring pipe and process connection (B) when cleaning with pigs.

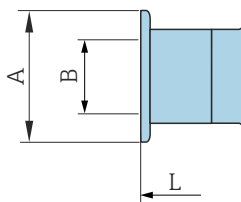

A0043179

DN [in]	Pipe [in]	A [in]	B [in]	L [in]
$\frac{1}{12}$ to $\frac{5}{16}$	0.5×0.065	0.98	0.37	5.63
$\frac{1}{2}$	0.75×0.065	0.98	0.62	5.63
1	1×0.065	1.98	0.87	5.63
$1 \frac{1}{2}$	1.5×0.065	1.98	1.37	8.66
2	2×0.065	2.52	1.87	8.66
3	3×0.065	3.58	2.87	8.66
4	4×0.083	4.68	3.83	8.66
6	6×0.109	6.57	5.78	11.81

Welding socket

Welding socket according to ISO 2037

1.4404/316L: order code for "Process connection", option IAS

Suitable for pipe ISO 2037

Surface roughness: $Ra_{max} = 30 \mu\text{in}$

i Please note the internal diameters of the measuring pipe and process connection (dimension B) when cleaning with pigs.

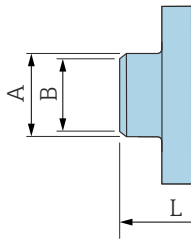

A0043180

DN [in]	Pipe [in]	A [in]	B [in]	L [in]
1/12 to 5/16	0.5 × 0.065	0.47	0.39	4.65
1/2	0.75 × 0.065	0.71	0.63	4.65
1	1 × 0.06	0.98	0.89	4.65
1 1/2	38 × 0.05	1.5	1.4	8.66
2	51 × 0.05	2.01	1.91	8.66
3	3 × 0.06	3	2.87	8.66
4	4 × 0.08	4	3.84	8.66
5	5.5 × 0.08	5.5	5.34	14.96
6	6.63 × 0.1	6.63	6.42	14.96

Welding socket according to ASME BPE

1.4404/316L: order code for "Process connection", option AAS

Suitable for pipe as per ASME BPE (DIN 11866 series C)

Surface roughness: $Ra_{max} = 30 \mu\text{in}$

i Please note the internal diameters of the measuring pipe and process connection (dimension B) when cleaning with pigs.

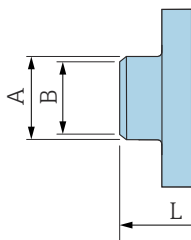

A0043180

DN [in]	Pipe [in]	A [in]	B [in]	L [in]
1/12 to 5/16	0.5 × 0.065	0.5	0.35	4.65
1/2	0.75 × 0.065	0.75	0.63	4.65
1	1 × 0.065	1	0.89	4.65
1 1/2	1.5 × 0.065	1.5	1.37	8.66
2	2 × 0.065	2	1.87	8.66
3	3 × 0.065	3	2.87	8.66
4	4 × 0.065	4	3.83	8.66
6	6 × 0.109	6	5.78	11.81

Mounting kits

Wall mounting kit

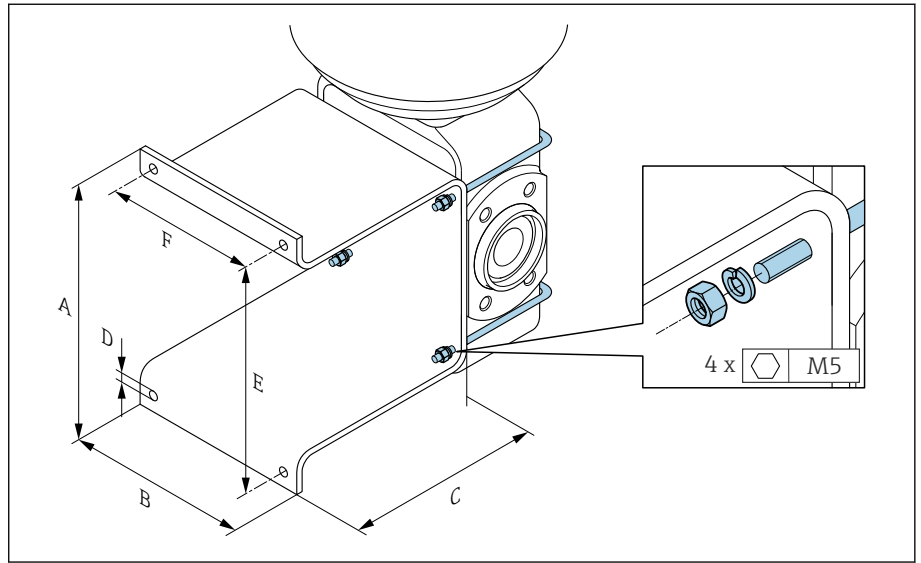

A	B	C	Ø D	E	F
[in]	[in]	[in]	[in]	[in]	[in]
5.39	4.33	4.72	0.28	4.92	3.46

Accessories

Spacer

Order code: DK5HB-****

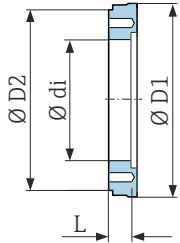

A0017294

DN [in]	di [in]	D1 [in]	D2 [in]	L [in]
3	2.87	5.54	5.55	1.30
4	3.83	6.56	6.38	1.30

Clamp connections with aseptic gasket seal available for order

Order code: DKH**-HF**

1.4404 (316L)

Suitable for pipe in accordance with ASME BPE (reduction)

Surface roughness: $Ra_{max} = 30 \mu\text{in}$



Please note the internal diameters of the measuring pipe and process connection (B) when cleaning with pigs.

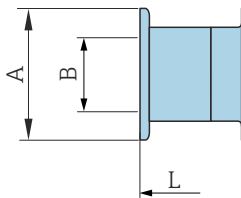

A0043179

DN [in]	Pipe [in]	A [in]	B [in]	L [in]
1/2	Pipe ODT 1	1.98	0.87	5.63

Threaded glands with O-ring seal available for order

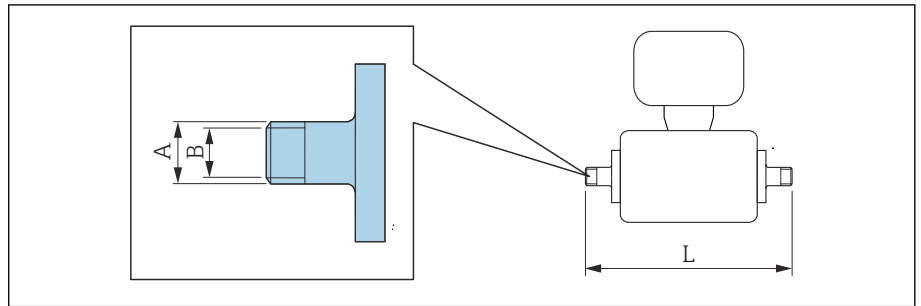

A0027509

Male thread
 1.4404 (316L)
 Order code: DKH****-GD****

DN [in]	Suitable for NPT female thread [in]	A [in]	B [in]	L [in]
$\frac{1}{12}$ to $\frac{3}{8}$	NPT $\frac{3}{8}$	R 0.61 × $\frac{3}{8}$	0.39	7.39
$\frac{1}{2}$	NPT $\frac{1}{2}$	R 0.79 × $\frac{1}{2}$	0.63	7.39
1	NPT 1	R 1 × 1	1.00	7.73

Surface roughness: Ra ≤ 63 µin

Female thread
 1.4404 (316L)
 Order code: DKH****-GC****

DN [in]	Suitable for NPT male thread [in]	A [in]	B [in]	L [in]
$\frac{1}{12}$ to $\frac{3}{8}$	NPT $\frac{3}{8}$	R 0.51 × $\frac{3}{8}$	0.35	6.93
$\frac{1}{2}$	NPT $\frac{1}{2}$	R 0.55 × $\frac{1}{2}$	0.63	6.93
1	NPT 1	R 0.67 × 1	1.07	7.41

Surface roughness: Ra ≤ 63 µin

Grounding rings

Order code: DK5HR-****

1.4435 (316L), Alloy C22, tantalum

For lap joint flange made of PVDF and PVC adhesive sleeve

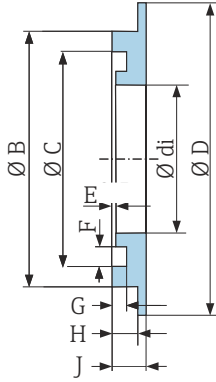

A0017673

DN [in]	di [in]	B [in]	C [in]	D [in]	D [in]	E [in]	G [in]	H [in]	J [in]
1/12 to 3/8	0.35	0.87	0.69	1.33	0.02	0.14	0.07	0.13	0.18
1/2	0.63	1.14	0.97	1.33	0.02	0.14	0.07	0.13	0.18
1	0.89	1.44	1.23	1.73	0.02	0.14	0.07	0.13	0.18

Protective cover

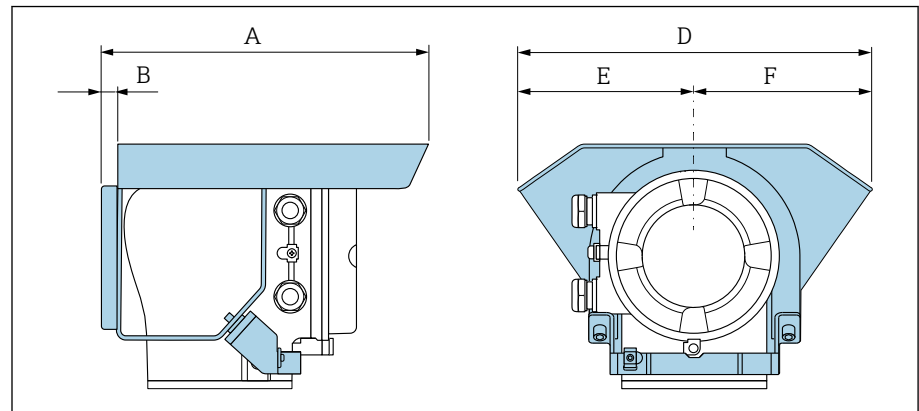

A0042332



A [in]	B [in]	D [in]	E [in]	F [in]
10.12	0.47	11.02	5.51	5.51

16 Accessories



Device-specific accessories	146
Communication-specific accessories	147
Service-specific accessory	147
System components	148

Device-specific accessories







Transmitter

Accessories	Description	Order number
Proline 10 transmitter	 Installation Instructions EA01350D	5XBBXX-*...*
Protective cover	Protects the device from weather exposure:  Installation Instructions EA01351D	71502730
Connecting cable	Can be ordered with the device. The following cable lengths are available: order code for "Cable, sensor connection" <ul style="list-style-type: none"> ▪ 5 m (16 ft) ▪ 10 m (32 ft) ▪ 20 m (65 ft) ▪ User-configurable cable length (m or ft)  Max. cable length: 200 m (660 ft)	DK5013-*...*



Sensor

Accessories	Description
Adapter set	Adapter connections for installing a Promag H instead of a Promag 30/33 A or Promag 30/33 H (DN 25). Consists of: <ul style="list-style-type: none"> ▪ 2 process connections ▪ Screws ▪ Seals
Seal set	Replacement of seals
Spacer	A spacer is needed if an installed device with DN 80 or DN 100 must be replaced and the new sensor is shorter.
Welding jig	Welding socket as process connection: welding jig for installation in pipe.
Grounding rings	Ground medium in lined measuring pipes.  Installation Instructions EA00070D
Grounding rings	Ground medium in lined measuring pipes.  Installation Instructions EA00070D
Wall mounting kit	Wall mounting kit (only DN 2 to 25 (1/12 to 1"))
Mounting kit	Consists of: <ul style="list-style-type: none"> ▪ 2 process connections ▪ Screws ▪ Seals



Communication-specific accessories

Accessories	Description
Commubox FXA195 USB/HART modem	Intrinsically safe HART communication with FieldCare and FieldXpert  Technical Information TI00404F
Commubox FXA291	Connects the Endress+Hauser devices with the CDI interface (= Endress+Hauser Common Data Interface) to the USB interface of a personal computer or laptop.  Technical Information TI405C/07
HART Loop Converter HMX50	Is used to evaluate and convert dynamic HART process variables to analog current signals or limit values.  <ul style="list-style-type: none"> ▪ Technical Information TI00429F ▪ Operating Instructions BA00371F
Fieldgate FXA42	Transmission of measured values from connected 4 to 20 mA analog and digital devices.  <ul style="list-style-type: none"> ▪ Technical Information TI01297S ▪ Operating Instructions BA01778S ▪ Product page: www.endress.com/fxa42
Field Xpert SMT70	Tablet PC for the configuration of the device. Enables mobile Plant Asset Management to manage the devices with a digital communication interface. Suitable for Zone 2.  <ul style="list-style-type: none"> ▪ Technical Information TI01342S ▪ Operating Instructions BA01709S ▪ Product page: www.endress.com/smt70
Field Xpert SMT77	Tablet PC for the configuration of the device. Enables mobile Plant Asset Management to manage the devices with a digital communication interface. Suitable for Zone 1.  <ul style="list-style-type: none"> ▪ Technical Information TI01418S ▪ Operating Instructions BA01923S ▪ Product page: www.endress.com/smt77

Service-specific accessory

Accessories	Description	Order number
Applicator	Software for selecting and sizing Endress+Hauser devices.	https://portal.endress.com/webapp/applicator
W@M Life Cycle Management	<ul style="list-style-type: none"> ▪ Information platform with software applications and services ▪ Supports the entire life cycle of the facility. 	www.endress.com/lifecyclemanagement
FieldCare	FDT-based plant asset management software from Endress+Hauser. Management and configuration of Endress+Hauser devices.  Operating Instructions BA00027S and BA00059S	<ul style="list-style-type: none"> ▪ Device driver: www.endress.com → Download Area ▪ CD-ROM (contact Endress+Hauser) ▪ DVD (contact Endress+Hauser)
DeviceCare	Software for connecting and configuring Endress+Hauser devices.  Innovation brochure IN01047S	<ul style="list-style-type: none"> ▪ Device driver: www.endress.com → Download Area ▪ CD-ROM (contact Endress+Hauser) ▪ DVD (contact Endress+Hauser)

System components

Accessories	Description
Memograph M	Graphic data manager: <ul style="list-style-type: none">▪ Record measured values▪ Monitor limit values▪ Analyze measuring points  <ul style="list-style-type: none">▪ Technical Information TI00133R▪ Operating Instructions BA00247R
iTEMP	Temperature transmitter: <ul style="list-style-type: none">▪ Measure the absolute pressure and gauge pressure of gases, vapors and liquids▪ Read the medium temperature  "Fields of Activity" document FA00006T

17 Appendix

Examples for electric terminals

150

Examples for electric terminals

Current output 4 to 20 mA HART (active)

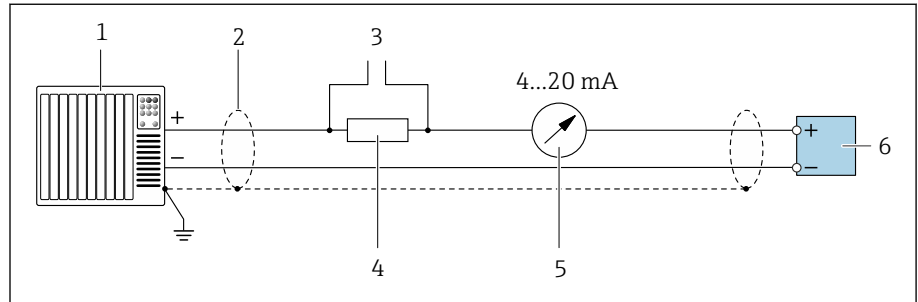

A0029055

- 1 Automation system with current input, e.g. PLC
- 2 Cable shield
- 3 Connection for HART operating devices
- 4 Resistor for HART communication ($\geq 250 \Omega$): observe max. load.
- 5 Analog display unit: observe max. load.
- 6 Transmitter

Current output 4 to 20 mA HART (passive)

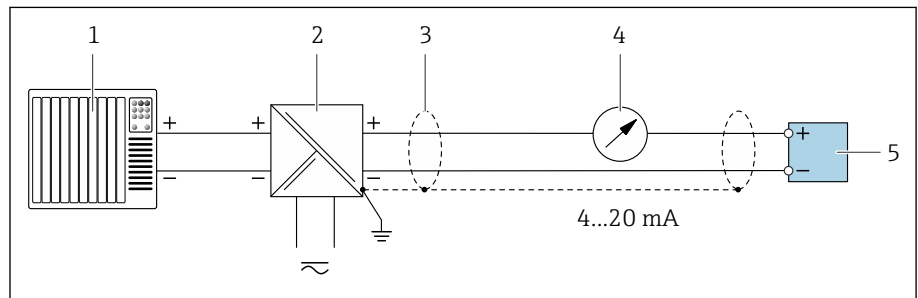

A0028762

- 1 Automation system with current input, e.g. PLC
- 2 Active barrier for supply voltage, e.g. RN22 1N
- 3 Cable shield
- 4 Analog display unit: observe max. load.
- 5 Transmitter

HART input (passive)

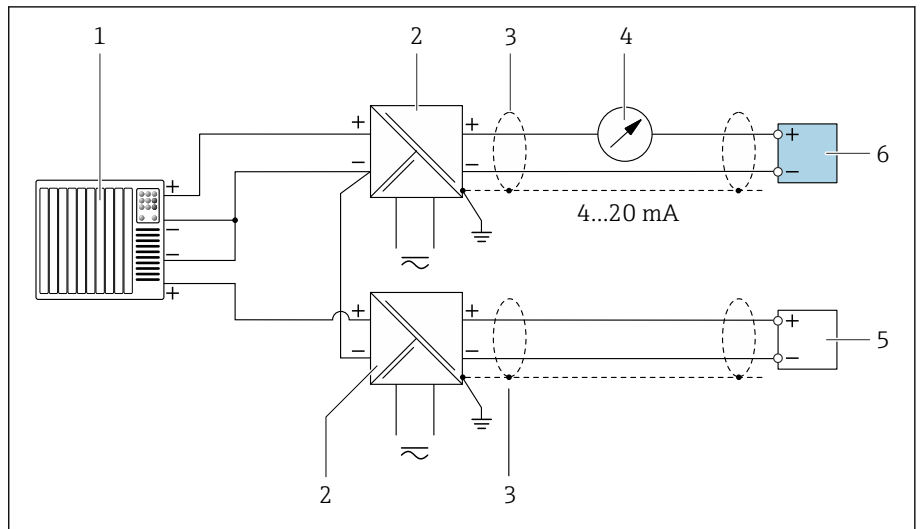

14 Connection example for HART input with a common negative (passive)

- 1 Automation system with current input, e.g. PLC
- 2 Active barrier for supply voltage, e.g. RN221N
- 3 Cable shield
- 4 Analog display unit: observe max. load.
- 5 Pressure measuring device, e.g. Cerabar M, Cerabar S: observe requirements
- 6 Transmitter

Pulse/frequency output (passive)

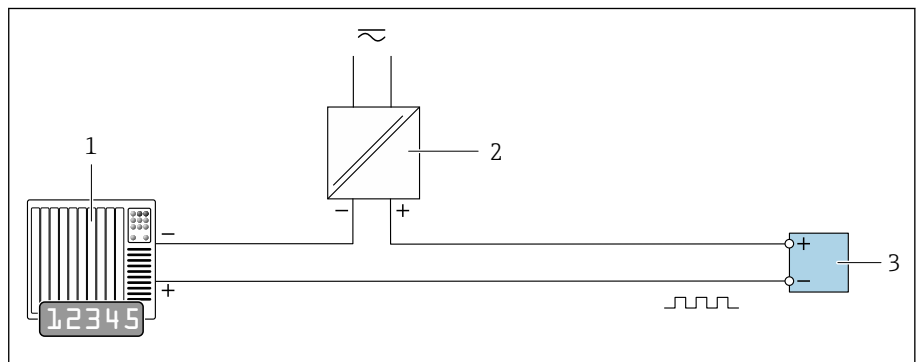

- 1 Automation system with pulse output and frequency input, e.g. PLC
- 2 Supply voltage
- 3 Transmitter: observe input values.

Switch output (passive)

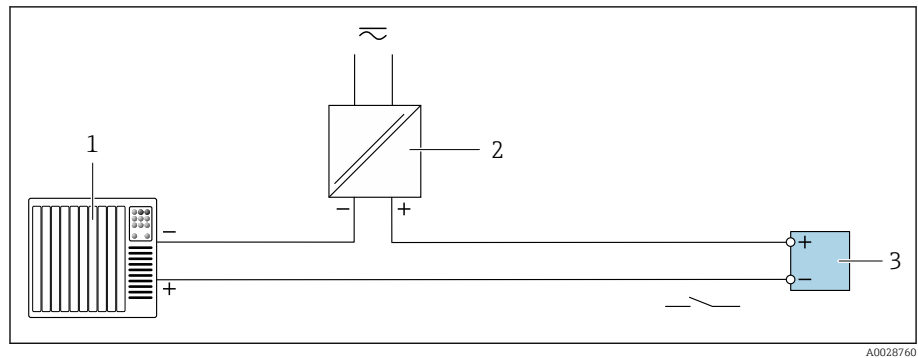

A0028760

- 1 Automation system with switch input, e.g. PLC
- 2 Supply voltage
- 3 Transmitter: observe input values.

Index

A

- Adapting the diagnostic behavior 76
- Ambient temperature
 - Influence 98
- Ambient temperature range 99
- Applicator 88
- Approvals 110

C

- Certificates 110
- Certificates and approvals 110
- Check
 - Connection 47
 - Installation 34
 - Received goods 16
- Checking the storage conditions (checklist) 21
- Checklist
 - Post-connection check 47
 - Post-installation check 34
- Cleaning in place (CIP) 100
- Cleaning with pigs 84
- Commissioning 61, 62
 - see Commissioning wizard
 - see Via local operation
 - see Via SmartBlue App
 - Switching on the device 63
- Commissioning the device 64
- Compatibility 24
- Conductivity 101
- Connecting cable terminal assignment
 - Sensor connection housing 39
- Connecting the connecting cable
 - Sensor connection housing 39
 - Transmitter connection housing 40

D

- Date of manufacture 17, 18
- Degree of protection 99
- Design
 - Device 22
- Designated use 16
- Device
 - Design 22
 - Disposal 86
 - Mounting the sensor 84
 - Removal 86
- Device components 22
- Device description files 58
- Device history 24
- Device locking, status 68
- Device name
 - Sensor 18
 - Transmitter 17
- Device reset
 - Settings 82

Device usage

see Designated use

Diagnostic information

- Design, description 74, 75
- DeviceCare 74
- FieldCare 74
- Light emitting diodes
 - LED 72
- Local display 73
- Overview 76
- Remedial measures 76
- Diagnostic information in FieldCare or DeviceCare . . . 74
- Diagnostic information via LED 72
- Diagnostic list 80
- Diagnostic message 73
- Diagnostics
 - Symbols 73
- Display
 - Current diagnostic event 79
 - Previous diagnostic event 79
- Display values
 - For locking status 68
- Disposal 85
- Disposing of the device 86

E

- Electromagnetic compatibility 100
- Electronics module 22
- Endress+Hauser services
 - Maintenance 84
- Environment
 - Ambient temperature 99
 - Storage temperature 99
 - Vibration-resistance and shock-resistance 99
- Error messages
 - see Diagnostic messages
- Event list 80
- Event logbook 80
- Extended order code
 - Sensor 18
 - Transmitter 17
- Exterior cleaning
 - Cleaning 84

F

- Filtering the event logbook 80
- Firmware history 24
- Fitted electrodes 108
- Flow limit 102

G

- Galvanic isolation 93
- General troubleshooting 70

H

- HART certification 110

- HART protocol
 Device variables 58
 Dynamic variables 58
- I**
- Identify device 17
Incoming acceptance (checklist) 16
Influence
 Ambient temperature 98
Influence of ambient temperature 98
Input 88
Interior cleaning 84, 100
 Cleaning 84
- L**
- Local display
 see Diagnostic message
 see In alarm condition
Local operation 64
Low flow cut off 93
- M**
- Magnetism 29
Magnetism and static electricity 29
Main electronics module 22
Maintenance tasks 84
 Replacing seals 84
Materials 107
Maximum measured error 97
Measured variable
 see Process variables
Measured variables via HART protocol 58
Measuring device
 Mounting the sensor
 Mounting grounding rings 30
 Welding socket 30
Measuring pipe specification 106
Measuring principle 16
Measuring range 88
Medium temperature range 101
- N**
- Nameplate
 Sensor 18
 Transmitter 17
Non-Ex approval 110
- O**
- Operable flow range 88
Operation 49, 67
Order code 17, 18
Output 90
Output signal 90
Overview of diagnostic information 76
- P**
- Packaging disposal 21
Pending diagnostic events 79
Performance characteristics 97
Pharmaceutical compatibility 110
- Post-connection check 62
Post-connection check (checklist) 47
Post-installation check 62
Post-installation check (checklist) 34
Post-installation check and post-connection check 62
Pressure Equipment Directive 110
Pressure loss 105
Pressure tightness 105
Pressure-temperature ratings 103
Process conditions
 Conductivity 101
 Flow limit 102
 Medium temperature 101
 Pressure loss 105
 Pressure tightness 105
 Pressure-temperature ratings 103
Product design 22
Product identification 17
- R**
- Radio approval 110
Reading out the event logbook 80
Reading the device locking status 68
Recycling of packaging materials 21
Reference operating conditions 97
Registered trademarks 9
Removing the device 86
Repeatability 98
Replacement seals 84
Replacing seals 84
- S**
- Safety instructions 11
Sensor nameplate 18
Serial number 17, 18
Services 84
Signal on alarm 93
SmartBlue App 64
 Operating options 55
Standards and guidelines 111
Static electricity 29
Status signals 73
Sterilization in place (SIP) 100
Storage 21
Storage conditions 21
Storage temperature 21, 99
Storage temperature range 99
Submenu
 Device management 68
 Event list 80
Surface roughness 108
Switching on the device 63
System design
 see Device design
System integration 57
- T**
- Temperature measurement response time 98

Temperature range	
Storage temperature	21
Tool	
Transport	19
Transmitter nameplate	17
Transport	
Transporting the device	19
Troubleshooting	
General	70
V	
Vibration-resistance and shock-resistance	99
W	
W@M Device Viewer	17
Weight	
Transport (notes)	19
Wiring the sensor connection housing	39
Wiring the transmitter housing	40



71510511

www.addresses.endress.com
