

IOM

INSTALLATION OPERATION
& MAINTENANCE

A150

METAL 1-1/2 INCH

AIR-OPERATED DOUBLE-DIAPHRAGM PUMP



TABLE OF CONTENTS

SECTION 1	WARNINGS, DANGERS AND CAUTIONS	3
SECTION 2	MODEL DESIGNATION MATRIX & REPAIR KITS	4-6
SECTION 3	PRINCIPLES OF OPERATION	7
SECTION 4	DIMENSIONAL DRAWINGS	8-9
SECTION 5	PERFORMANCE CURVES (RUBBER, TPE, & PTFE)	
	1-1/2" DISCHARGE PORTS.....	10
	1-1/4" TOP DISCHARGE PORT	11
SECTION 6	INSTALLATION	
	INSTALLATION.....	12-13
	TROUBLESHOOTING.....	14
	OPERATION	15
	MAINTENANCE	15
SECTION 7	REPAIR AND ASSEMBLY	
	PUMP WET END REMOVAL.....	16-17
	AIR VALVE REMOVAL.....	18-19
	PILOT VALVE REMOVAL	20-21
	TORQUE SPECIFICATION CHART.....	21
SECTION 8	EXPLODED VIEWS & PARTS LIST	
	THREADED ALUMINUM AND STAINLESS STEEL FULL STROKE.....	22-24
	THREADED ALUMINUM AND STAINLESS STEEL PTFE SHORT STROKE	25-27
	FLANGED STAINLESS STEEL FULL STROKE	28-30
	FLANGED STAINLESS STEEL PTFE SHORT STROKE	31-33
SECTION 9	ELASTOMERS	34
SECTION 10	WARRANTY AND REGISTRATION	35

CAUTIONS — READ FIRST!

READ THESE WARNINGS AND SAFETY PRECAUTIONS PRIOR TO INSTALLATION OR OPERATION. FAILURE TO COMPLY WITH THESE INSTRUCTIONS COULD RESULT IN PERSONAL INJURY AND OR PROPERTY DAMAGE. RETAIN THESE INSTRUCTIONS FOR FUTURE REFERENCE.

WARNING Pump, valves and all containers must be properly grounded prior to handling flammable fluids and/or whenever static electricity is a hazard.

WARNING Prior to servicing the pump, ensure that the air and fluid lines are closed and disconnected. While wearing personal protective equipment, flush, drain and process liquid from the pump in a safe manner.

WARNING The TX marking refers to the maximum surface temperature depending not on the equipment itself, but mainly on operating conditions. In this case, the maximum surface temperature depends upon the temperature of the process fluids.

WARNING For pump models with non-metallic manifolds, air valves, or chambers: When the relative humidity in the surrounding atmosphere is above 30%, the equipment must not be touched by personnel unless first wiped down with a damp cloth.

WARNING Maintenance must not be performed when a hazardous atmosphere is present.

WARNING Use only with liquid process fluid.

WARNING This equipment's ambient temperature range is 32°F (0°C) to 104°F (40°C)

WARNING Do not operate the pump with fluids or in temperatures which are less than 32°F (0°C)

CAUTION The temperature of the process fluid and air input must be no more than 36°F (20°C) less of the maximum temperature allowed for the appropriate non-metallic material. See the list of temperatures below for each material's maximum recommended temperature:

Buna-N (Nitrile):	10°F to 180°F (-12°C to 82°C)
Geolast®:	10°F to 180°F (-12°C to 82°C)
EPDM:	-40°F to 280°F (-40°C to 138°C)
Santoprene®:	-40°F to 225°F (-40°C to 107°C)
FKM:	-40°F to 350°F (-40°C to 177°C)
PTFE:	40°F to 220°F (4°C to 104°C)
Polyethylene:	32°F to 158°F (0°C to 70°C)
Polypropylene:	32°F to 180°F (0°C to 82°C)
PVDF:	0°F to 250°F (-18°C to 121°C)
Nylon:	0°F to 200°F (-18°C to 93°C)

Temperature limits are solely based upon mechanical stress and certain chemicals will reduce the maximum operating temperature. The allowable temperature range for the process fluid is determined by the materials in contact with the fluid being pumped. Consult a chemical resistance guide for chemical compatibility and a more precise safe temperature limit. Always use minimum air pressure when pumping at elevated temperatures.

WARNING = Hazards or unsafe practices which could result in severe personal injury, death or substantial property damage

CAUTION = Hazards or unsafe practices which could result in minor personal injury, product or property damage.

CAUTION It is the end user's responsibility to maintain the process fluid's temperature during use.

CAUTION Do not connect a compressed air source to the exhaust port of the pump.

CAUTION Do not lubricate air supply.

CAUTION Do not exceed 120 psig (8.3 bar) air-inlet pressure.

CAUTION Do not exceed 10 psig (0.7 bar) or 23 ft-H₂O suction pressure.

CAUTION Ensure all wetted components are chemically compatible with the process fluid and the cleaning fluid.

CAUTION Ensure pump is thoroughly cleaned and flushed prior to installation into a process line.

CAUTION Always wear Personal Protective Equipment (PPE) when operating pump.

CAUTION Close and disconnect all compressed air and bleed all air from the pump prior to service. Remove all process fluid in a safe manner prior to service.

CAUTION Blow out all compressed air lines in order to remove any debris, prior to pump installation. Ensure that the muffler is properly installed prior to pump operation.

CAUTION Ensure air exhaust is piped to atmosphere prior to a submerged installation.

CAUTION Ensure all hardware is set to correct torque values prior to operation.

CAUTION The equipment must be inspected for visible damage prior to use.

WARNING This product can expose you to chemicals including Nickel, Chromium, Cadmium, or Cobalt, which are known to the State of California to cause cancer and/or birth defects or other reproductive harm. For more information, go to www.P65Warnings.ca.gov.

SECTION 2

MODEL DESIGNATION MATRIX & REPAIR KITS - THREADED ALUMINUM

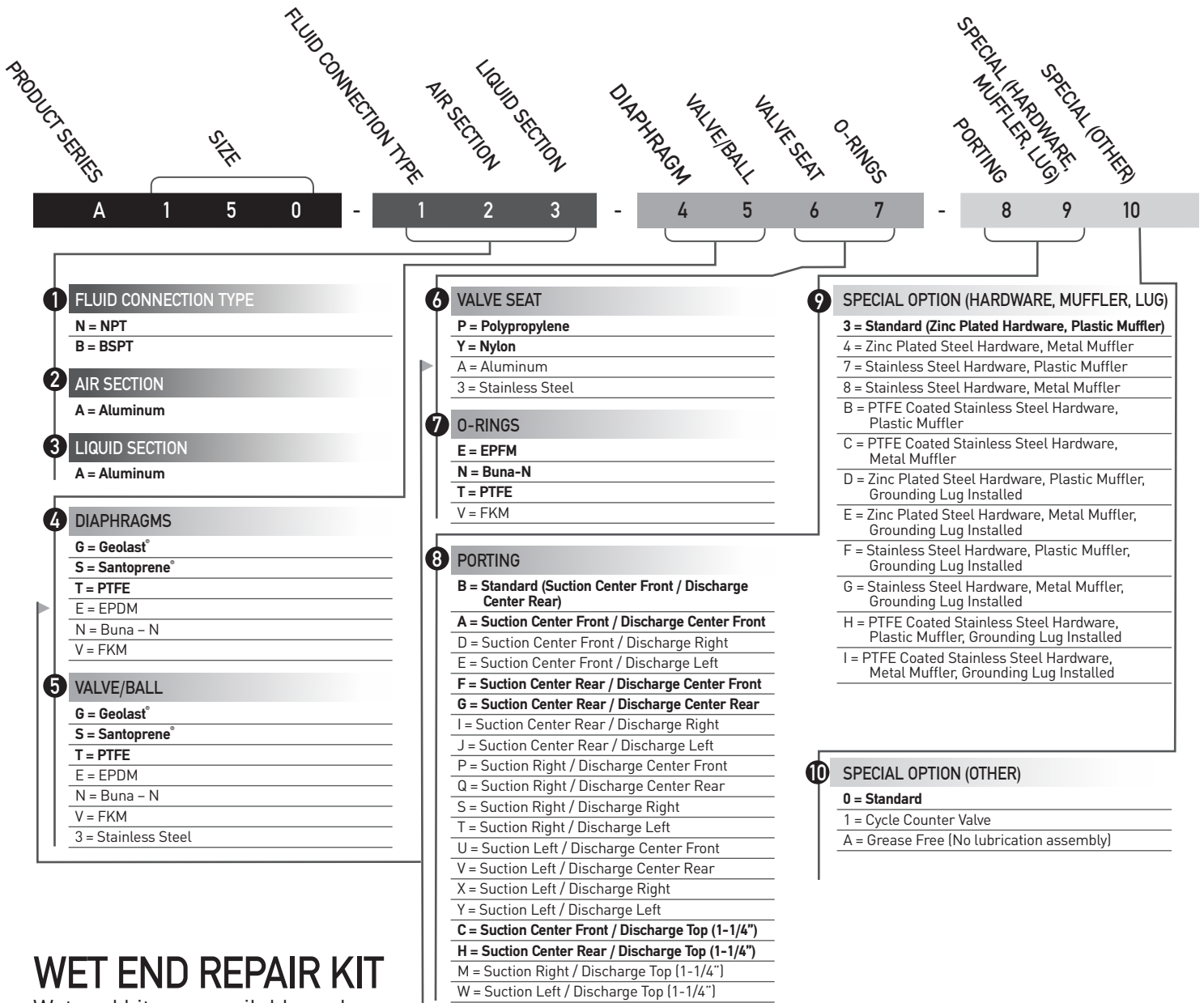

WET END REPAIR KIT

Wet end kits are available and consist of diaphragms, (back-up diaphragms if required), balls, seats and seat O-rings. See matrix below.

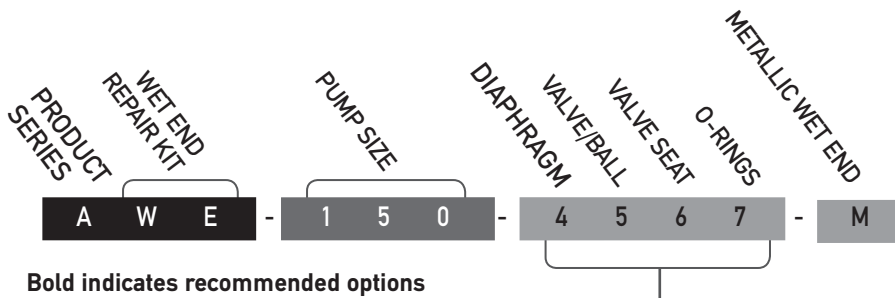

Bold indicates recommended options

AIR END REPAIR KIT

Air end repair kit contains pilot sleeve assembly and main air valve.

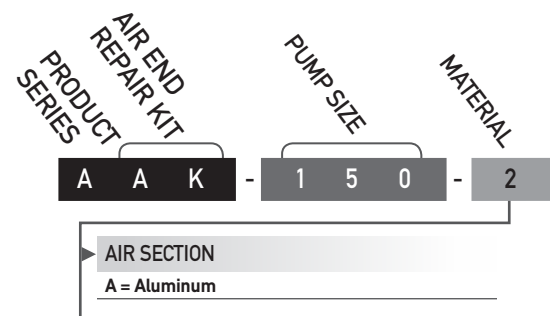

MODEL DESIGNATION MATRIX & REPAIR KITS - THREADED STAINLESS STEEL

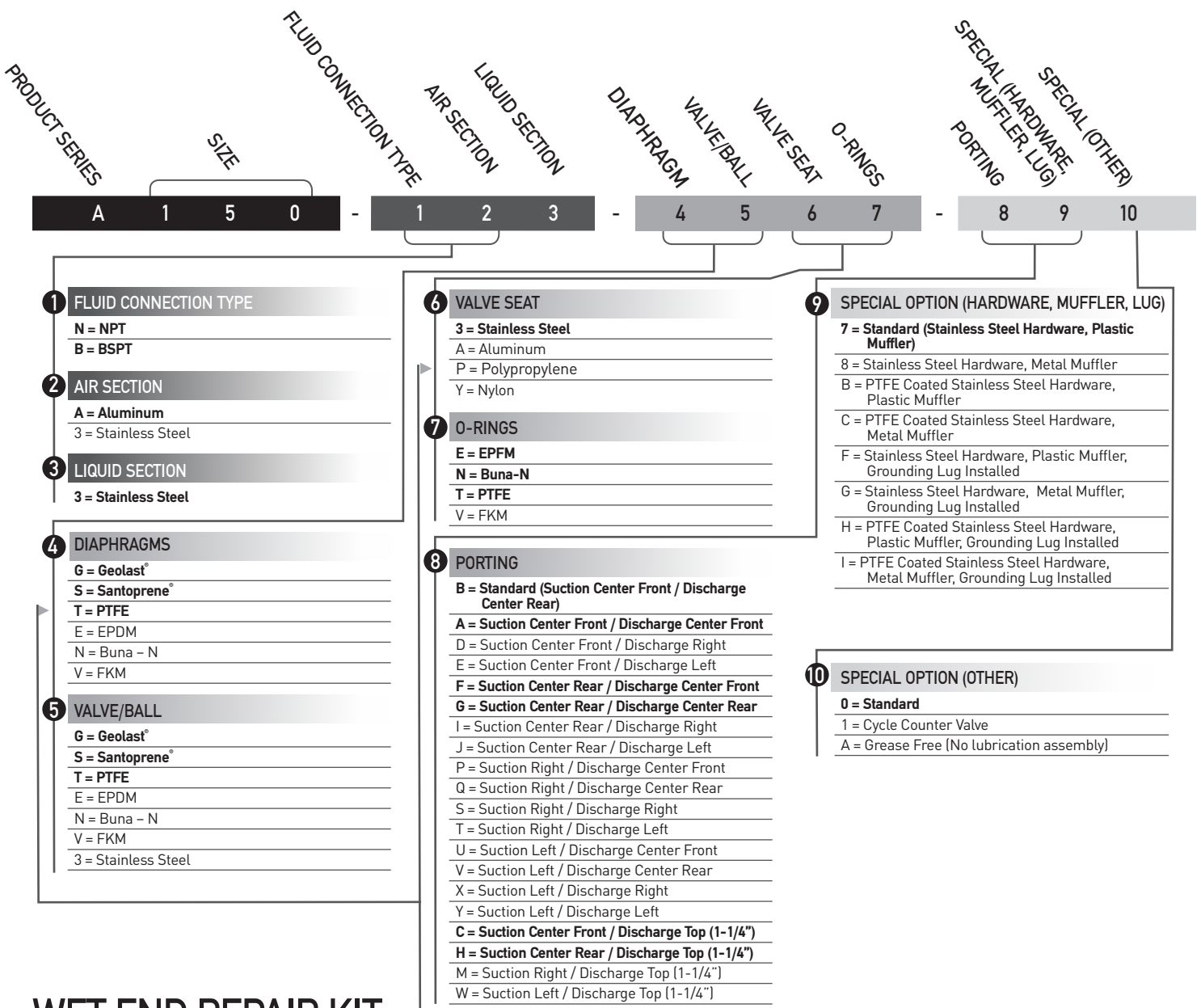

WET END REPAIR KIT

Wet end kits are available and consist of diaphragms, (back-up diaphragms if required), balls, seats and seat O-rings. See matrix below.

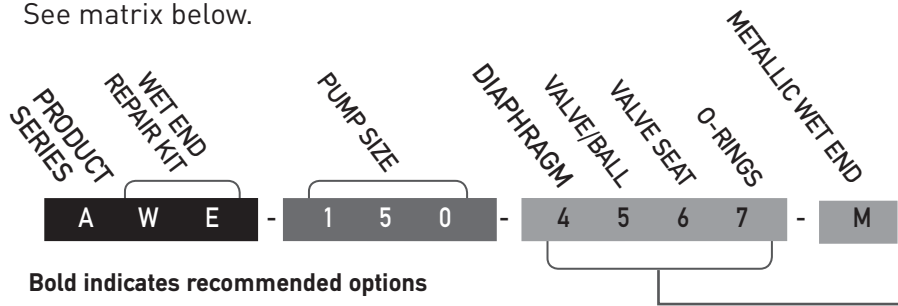

Bold indicates recommended options

AIR END REPAIR KIT

Air end repair kit contains pilot sleeve assembly and main air valve.

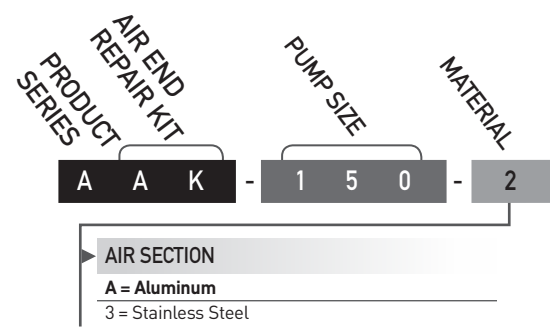

AIR SECTION
A = Aluminum
3 = Stainless Steel

SECTION 2

MODEL DESIGNATION MATRIX & REPAIR KITS - FLANGED STAINLESS STEEL

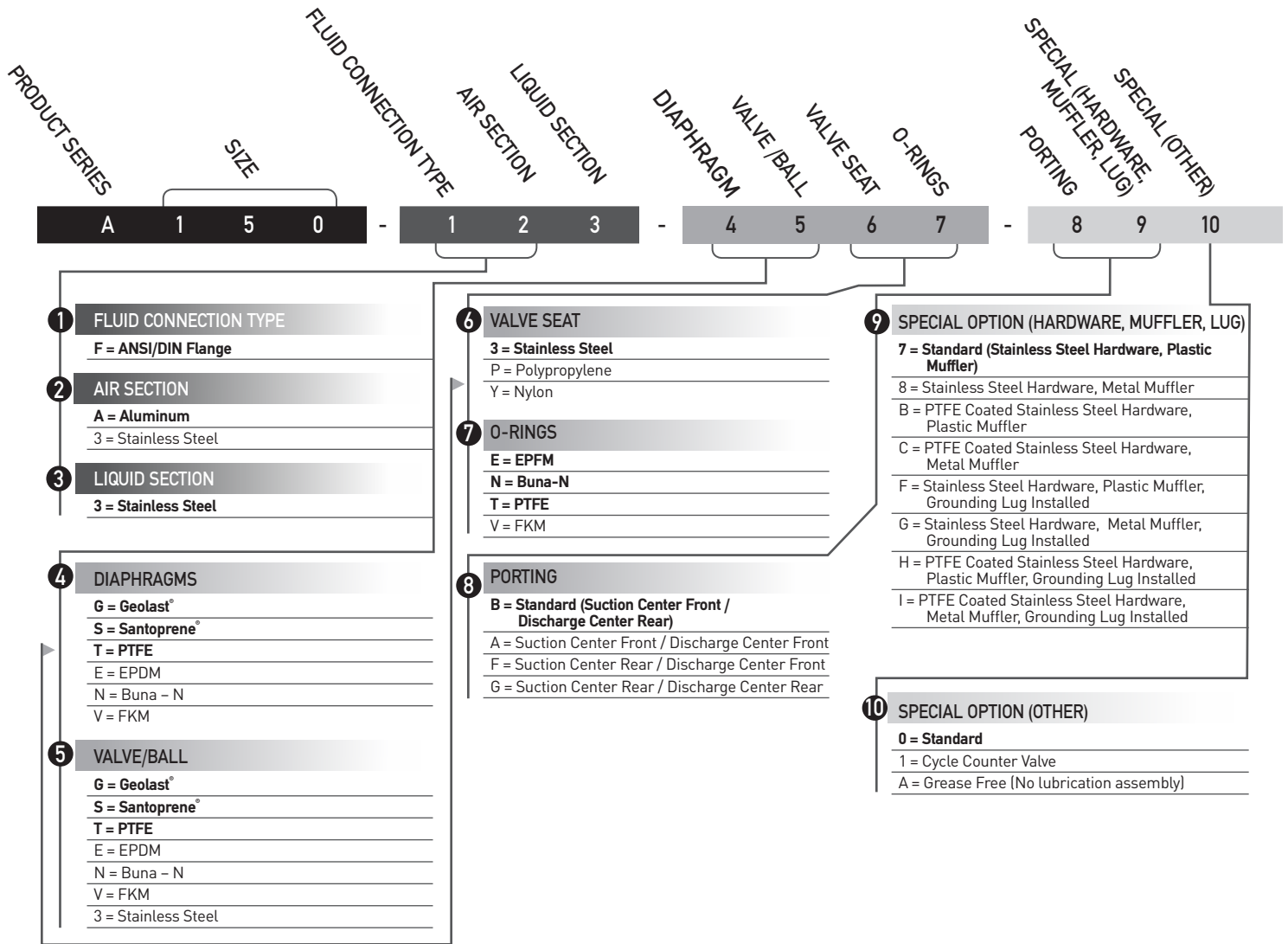

WET END REPAIR KIT

Wet end kits are available and consist of 2 diaphragms, (back-up diaphragms if required), 4 balls, 4 seats, and 4 seat O-rings. See matrix below.

AIR END REPAIR KIT

Air end repair kit contains pilot sleeve assembly and main air valve.



Bold indicates recommended options

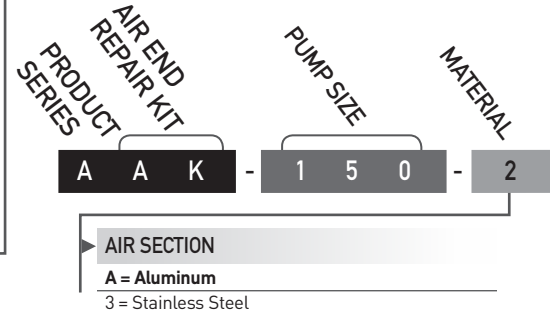

PRINCIPLES OF OPERATION

HOW AN AIR OPERATED DOUBLE DIAPHRAGM PUMP WORKS

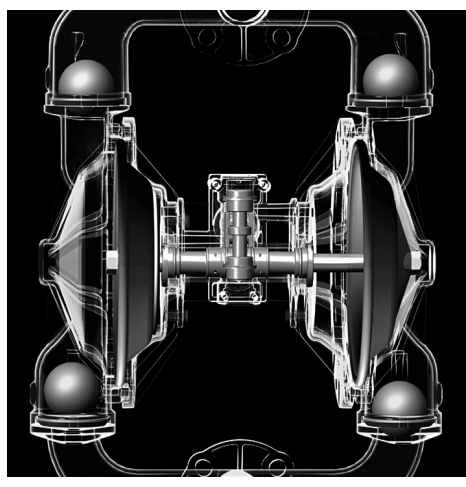

The air-valve directs pressurized air behind the diaphragm on the right, causing the diaphragm on the right to move outward (to the right).

Since both the right diaphragm and the left diaphragm are connected via a diaphragm rod, when the right diaphragm moves to the right, the left diaphragm (through the action of the diaphragm rod) moves to the right also.

When the diaphragm on the left side is moving to the right, it is referred to as suction stroke. When the left diaphragm is in its suction stroke, the left suction ball moves upward (opens) and the left discharge ball moves downward (closes). This action creates suction and draws liquid into the left side chamber.

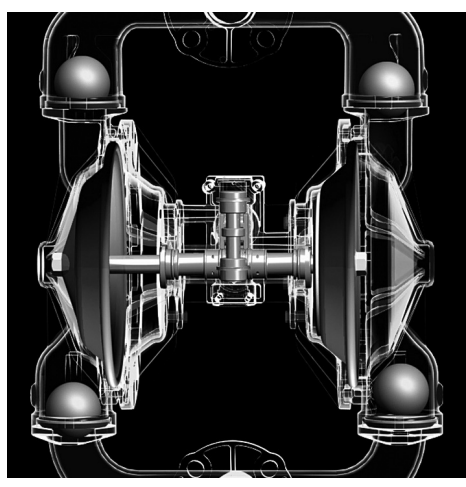

The air-valve directs pressurized air behind the left diaphragm, causing the left diaphragm to move outward (to the left).

Since both the left diaphragm and the right diaphragm are connected via a diaphragm rod, when the left diaphragm moves to the left, the right diaphragm (through the action of the diaphragm rod) moves to the left also.

When the diaphragm on the left side moves outward, the left discharge ball moves upward (opens) and the left suction ball moves downward (closes). This causes the liquid to leave the left side liquid outlet of the pump.

Simultaneously, the right diaphragm moves inward (to the left), which causes the right suction ball to open and the right discharge to close, which in turn causes suction, drawing liquid into the right chamber.

The process of alternating right suction / left discharge (and vice-versa) continues as long as compressed air is supplied to the pump.

PUMP DIMENSIONS

THREADED ALUMINUM & STAINLESS STEEL

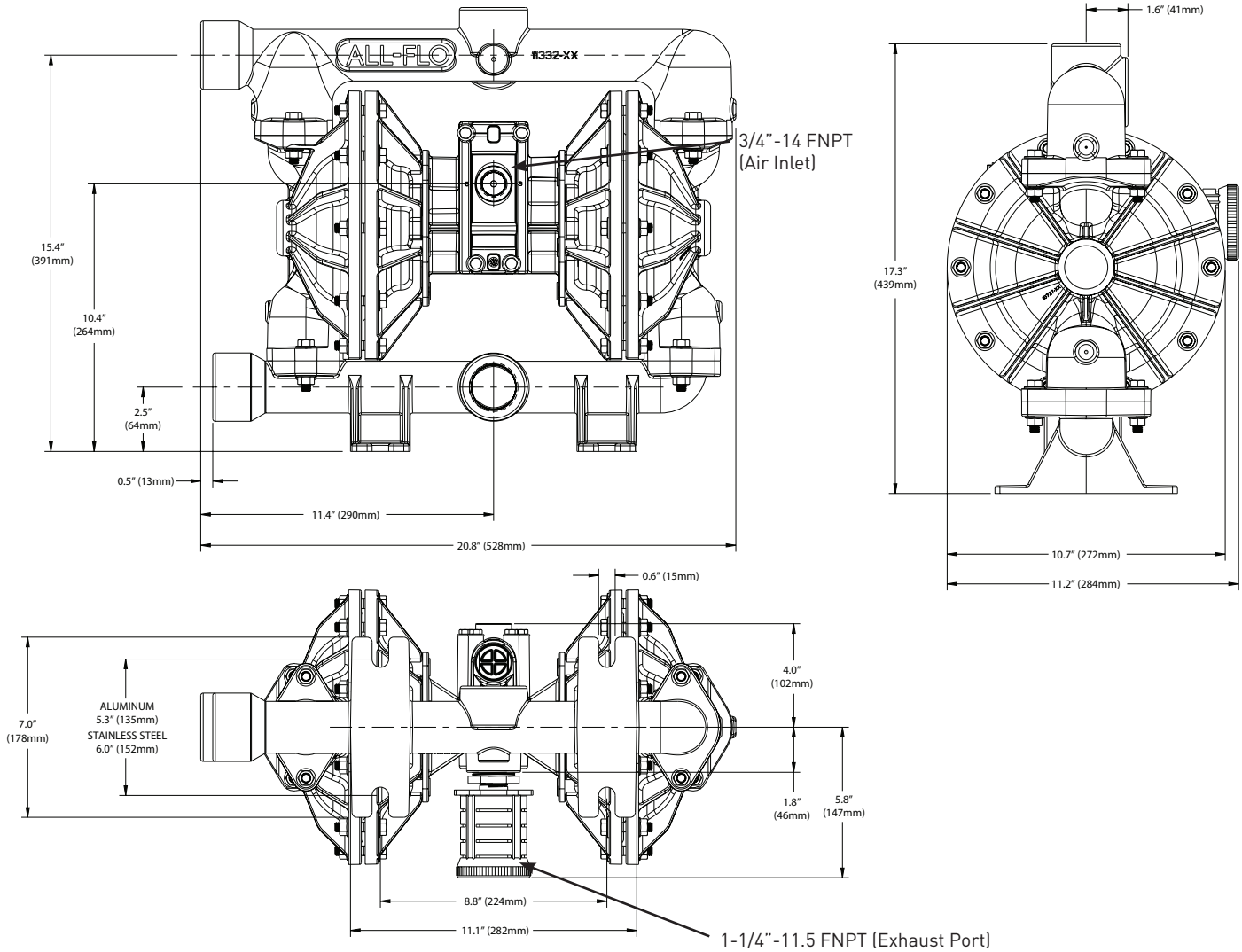

* Note: Standard Muffler shown.

**Note: A reducer bushing is included with the standard muffler which reduces the port to 3/4"-14 FNPT.

*** All liquid ports are 1-1/2 inch FNPT or FBSPT, except top discharge port which is 1-1/4 inch FNPT or FBSPT.

PUMP DIMENSIONS

FLANGED STAINLESS STEEL

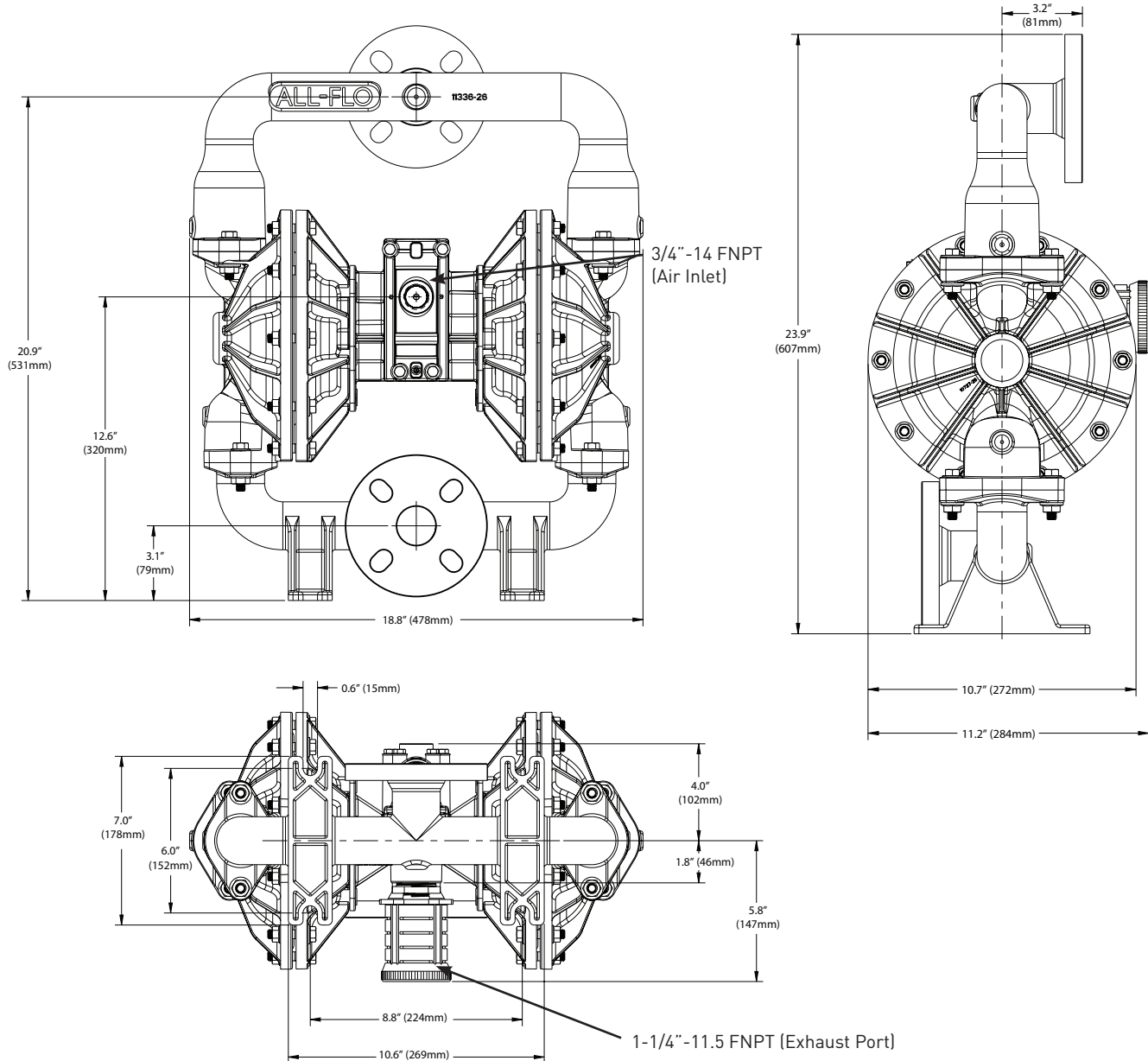

* Note: Standard Muffler shown.

**Note: A reducer bushing is included with the standard muffler which reduces the port to 3/4" - 14 FNPT.

PERFORMANCE CURVES 1-1/2" DISCHARGE PORTS

PERFORMANCE CURVE (1-1/2" RUBBER)*

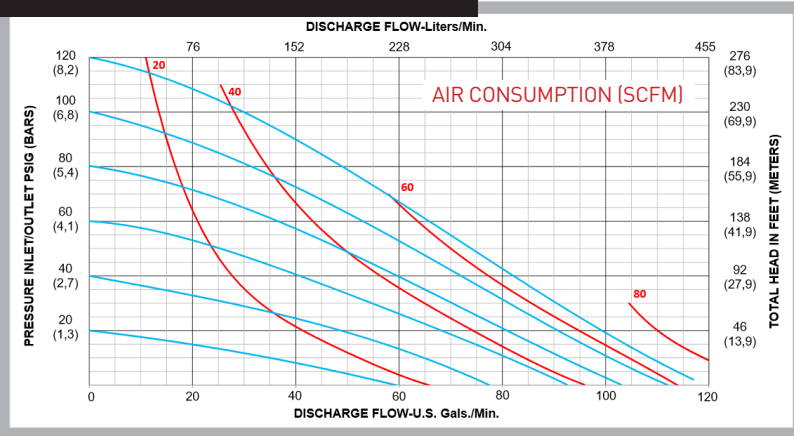

Performance Specifications

Max. Flow:	115 gpm (435 lpm)
Max. Air Pressure:	120 psi (8.3 bar)
Max. Solids:	1/4" (6.4 mm)
Max. Suction Lift Dry:	22 ft-H ₂ O (6.7 m-H ₂ O)
Max. Suction Lift Wet:	31 ft-H ₂ O (9.4 m-H ₂ O)
Weight Threaded:	AL-45 lbs (20 kg)/SS-70 lbs (32 kg)
Weight Flanged:	SS-84 lbs (38 kg)
Air Inlet:	3/4" FNPT
Liquid Inlet:	1-1/2" FNPT, 1-1/2" FBSPT, or ANSI/DIN Flanged
Liquid Outlet:	1-1/2" FNPT, 1-1/2" FBSPT, or ANSI/DIN Flanged
Height:	17.3" (439 mm) Threaded / 23.9" (607 mm) Flanged
Width:	20.8" (528 mm) Threaded / 18.8" (478 mm) Flanged
Depth:	11.2" (284 mm) Threaded & Flanged

PERFORMANCE CURVE (1-1/2" TPE)*

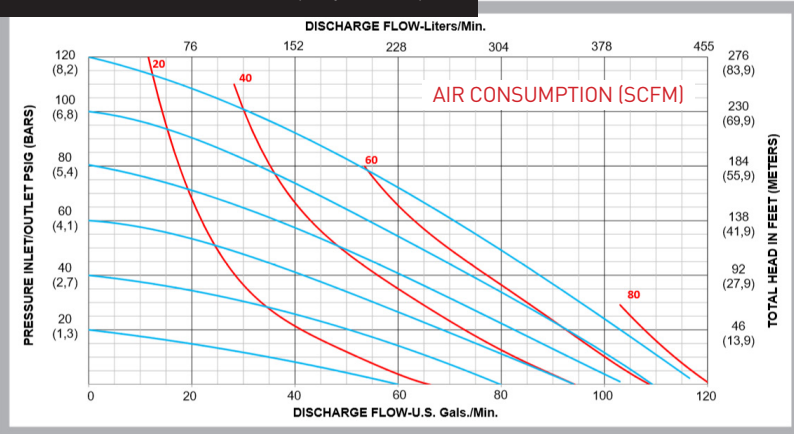

Performance Specifications

Max. Flow:	115 gpm (435 lpm)
Max. Air Pressure:	120 psi (8.3 bar)
Max. Solids:	1/4" (6.4 mm)
Max. Suction Lift Dry:	22 ft-H ₂ O (6.7 m-H ₂ O)
Max. Suction Lift Wet:	31 ft-H ₂ O (9.4 m-H ₂ O)
Weight Threaded:	AL-45 lbs (20 kg)/ SS-70 lbs (32 kg)
Weight Flanged:	SS-84 lbs (38 kg)
Air Inlet:	3/4" FNPT
Liquid Inlet:	1-1/2" FNPT, 1-1/2" FBSPT, or ANSI/DIN Flanged
Liquid Outlet:	1-1/2" FNPT, 1-1/2" FBSPT, or ANSI/DIN Flanged
Height:	17.3" (439 mm) Threaded / 23.9" (607 mm) Flanged
Width:	20.8" (528 mm) Threaded / 18.8" (478 mm) Flanged
Depth:	11.2" (284 mm) Threaded & Flanged

PERFORMANCE CURVE (1-1/2" PTFE)*

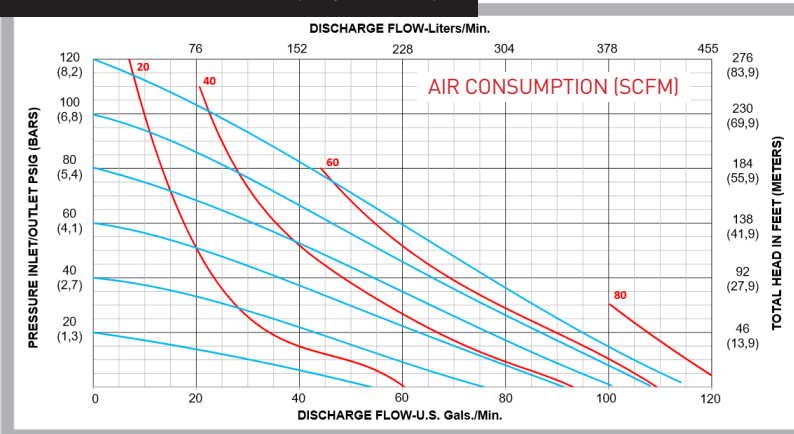

Performance Specifications

Max. Flow:	115 gpm (435 lpm)
Max. Air Pressure:	120 psi (8.3 bar)
Max. Solids:	1/4" (6.4 mm)
Max. Suction Lift Dry:	18 ft-H ₂ O (5.5 m-H ₂ O)
Max. Suction Lift Wet:	31 ft-H ₂ O (9.4 m-H ₂ O)
Weight Threaded:	AL-45 lbs (20 kg)/ SS-70 lbs (32 kg)
Weight Flanged:	SS-84 lbs (38 kg)
Air Inlet:	3/4" FNPT
Liquid Inlet:	1-1/2" FNPT, 1-1/2" FBSPT, or ANSI/DIN Flanged
Liquid Outlet:	1-1/2" FNPT, 1-1/2" FBSPT, or ANSI/DIN Flanged
Height:	17.3" (439 mm) Threaded / 23.9" (607 mm) Flanged
Width:	20.8" (528 mm) Threaded / 18.8" (478 mm) Flanged
Depth:	11.2" (284 mm) Threaded & Flanged

*Flow rates indicated on all three charts shown were determined by pumping water at flooded suction.

For optimum life and performance, pumps should be specified so that daily operation parameters will fall in the center of the pump performance curve.

PERFORMANCE CURVES 1-1/4" TOP DISCHARGE PORT

PERFORMANCE CURVE (1-1/4" RUBBER)*

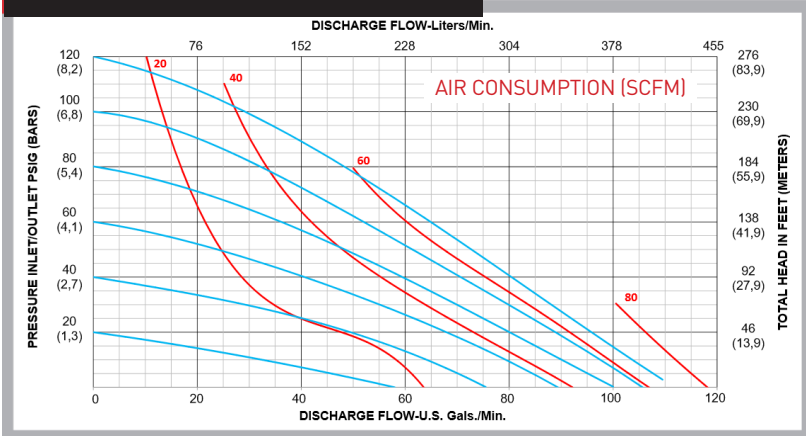

Performance Specifications

Max. Flow:	105 gpm (398 lpm)
Max. Air Pressure:	120 psi (8.3 bar)
Max. Solids:	1/4" (6.4 mm)
Max. Suction Lift Dry:	22 ft-H ₂ O (6.7 m-H ₂ O)
Max. Suction Lift Wet:	31 ft-H ₂ O (9.4 m-H ₂ O)
Weight Threaded:	AL-45 lbs (20 kg) / SS-70 lbs (32 kg)
Air Inlet:	3/4" FNPT
Liquid Inlet:	1-1/2" FNPT, 1-1/2" FBSPT
Liquid Outlet:	1-1/4" FNPT, 1-1/2" FBSPT
Height:	17.3" (439 mm) Threaded
Width:	20.8" (528 mm) Threaded
Depth:	11.2" (284 mm) Threaded

PERFORMANCE CURVE (1-1/4" TPE)*

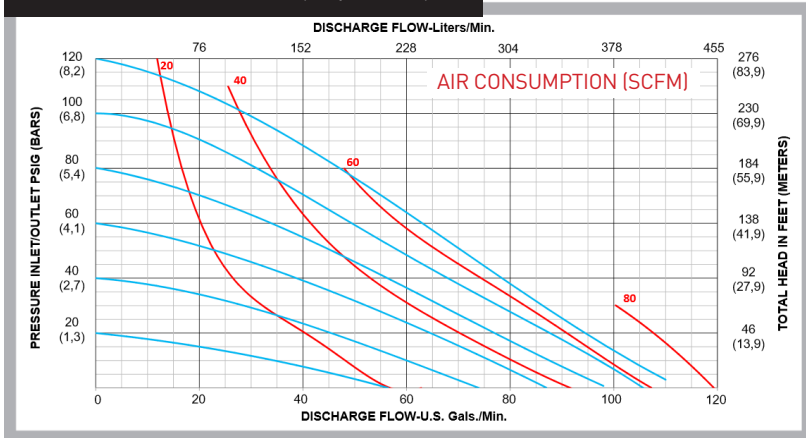

Performance Specifications

Max. Flow:	105 gpm (398 lpm)
Max. Air Pressure:	120 psi (8.3 bar)
Max. Solids:	1/4" (6.4 mm)
Max. Suction Lift Dry:	22 ft-H ₂ O (6.7 m-H ₂ O)
Max. Suction Lift Wet:	31 ft-H ₂ O (9.4 m-H ₂ O)
Weight Threaded:	AL-45 lbs (20 kg) / SS-70 lbs (32 kg)
Air Inlet:	3/4" FNPT
Liquid Inlet:	1-1/2" FNPT, 1-1/2" FBSPT
Liquid Outlet:	1-1/4" FNPT, 1-1/2" FBSPT
Height:	17.3" (439 mm) Threaded
Width:	20.8" (528 mm) Threaded
Depth:	11.2" (284 mm) Threaded

PERFORMANCE CURVE (1-1/4" PTFE)*

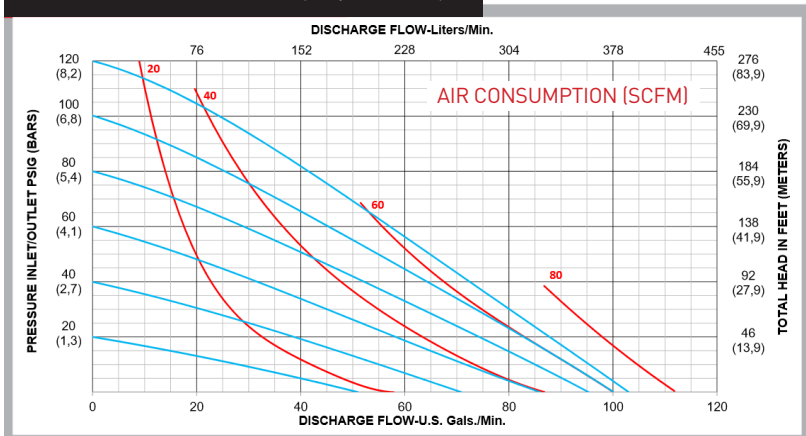

Performance Specifications

Max. Flow:	105 gpm (398 lpm)
Max. Air Pressure:	120 psi (8.3 bar)
Max. Solids:	1/4" (6.4 mm)
Max. Suction Lift Dry:	18 ft-H ₂ O (5.5 m-H ₂ O)
Max. Suction Lift Wet:	31 ft-H ₂ O (9.4 m-H ₂ O)
Weight Threaded:	AL-45 lbs (20 kg) / SS-70 lbs (32 kg)
Air Inlet:	3/4" FNPT
Liquid Inlet:	1-1/2" FNPT, 1-1/2" FBSPT
Liquid Outlet:	1-1/4" FNPT, 1-1/2" FBSPT
Height:	17.3" (439 mm) Threaded
Width:	20.8" (528 mm) Threaded
Depth:	11.2" (284 mm) Threaded

*Flow rates indicated on all three charts shown were determined by pumping water at flooded suction.

For optimum life and performance, pumps should be specified so that daily operation parameters will fall in the center of the pump performance curve.

INSTALLATION, TROUBLESHOOTING AND MAINTENANCE

INSTALLATION PIPING

Whenever possible ensure the pump is installed using the shortest possible pipe lengths with the minimum amount of pipe fittings. Ensure all piping is supported independent of the pump.

Suction and discharge piping should not be smaller than the connection size of the pump. When pumping liquids of high viscosity, larger piping may be used, in order to reduce frictional pipe loss.

Employ flexible hoses in order to eliminate the vibration caused by the pump. Mounting feet can also be used to reduce vibration effects.

All hoses should be reinforced, non-collapsible and be capable of high vacuum service. Ensure that all piping and hoses are chemically compatible with the process and cleaning fluid.

For processes where pulsation effects should be reduced, employ a pulsation dampener on the discharge side of the pump.

For self-priming applications, ensure all connections are airtight and the application is within the pumps dry-lift capability. Refer to product specifications for further details.

For flooded suction applications, install a gate valve on the suction piping in order to facilitate service.

For unattended flooded suction operation, it is recommended to pipe the exhaust air above the liquid source. In the event of a diaphragm failure this will reduce or eliminate the possibility of liquid discharging through the exhaust onto the ground.

LOCATION

Ensure that the pump is installed in an accessible location, in order to facilitate future service and maintenance.

AIR

Ensure that the air supply is sufficient for the volume of air required by the pump. Refer to product specifications for further details. For reliable operation, install a 5 micron air filter, air-valve and pressure regulator. Do not exceed the pumps maximum operating pressure of 120 psig.

REMOTE OPERATION

Utilize a three way solenoid valve for remote operation. This ensures that air between the solenoid and the pump is allowed to “bleed off,” ensuring reliable operation. Liquid transfer volume is estimated by multiplying displacement per stroke times the number of strokes per minute

NOISE

Correct installation of the muffler reduces sound levels. Refer to product specifications for further details.

SUBMERGED OPERATION

For submersible operation, pipe the air exhaust to atmosphere

GROUNDING THE PUMP

Loosen grounding screw and install a grounding wire. Tighten grounding screw. Wire size should be a 12 gauge wire or larger. Connect the other end of the wire to a true earth ground. Equipment must be grounded to achieve ATEX rating and it is recommended to configure the pump with a grounding lug option.



SUGGESTED INSTALLATION

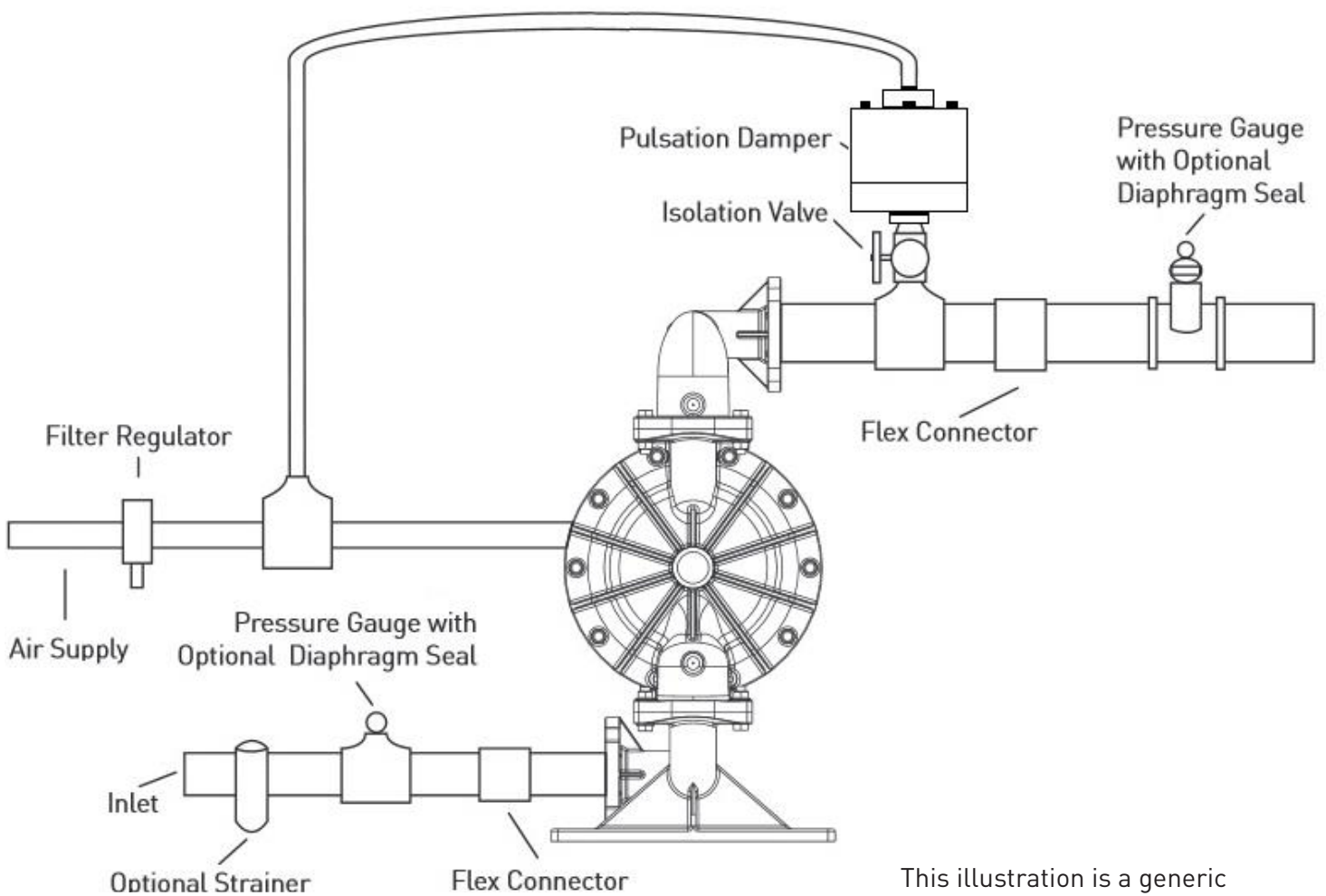

This illustration is a generic representation of an air operated double-diaphragm pump.

TROUBLESHOOTING

PROBLEM

EFFECT/SOLUTION

Pump Will Not Cycle

Discharge line closed or plugged
 Discharge filter blocked
 Check valve stuck
 Air filter blocked
 Air supply valve closed
 Air supply hooked up to muffler side of pump
 Compressor not producing air or turned off
 Muffler iced or blinded
 Diaphragm ruptured
 Air line in plant air supply lines ruptured
 Air valve wear/debris
 Pilot sleeve wear/debris
 Diaphragm rod broken
 Diaphragm plate loose

Pumped Fluid Coming Out of Muffler

Diaphragm ruptured
 Diaphragm plate loose
 Inlet liquid pressure excessive (above 10 psig)

Pump Cycles but no Flow

Inlet strainer clogged
 Suction valve closed
 Suction line plugged
 No liquid in the suction tank
 Suction lift excessive
 Debris stuck in valves
 Excessive wear of check valves
 Air leak on suction side with suction lift

Pump Cycles with Closed Discharge Valve

Debris stuck in check valve
 Excessive wear of check valves

Pump Running Slowly/Not Steady

Air compressor undersized
 Leak in air supply
 Air-line, filter regulator or needle valve undersized
 Muffler partially iced or blinded
 Air valve gasket leak or misalignment
 Air valve wear/debris
 Pilot sleeve wear/debris
 Liquid fluid filter blocked
 Pump may be cavitating, reduce speed of operation
 Suction strainer clogged

Pump Will Not Prime

Air leak in suction pipe
 Air leak in pump manifold connections
 Suction strainer and lines clogged
 Excessive lift conditions
 Check valve wear
 Debris in check valve

OPERATION

The Air-Operated Double Diaphragm Pump requires a minimum of 20 psig of air to operate, with some variation according to diaphragm material. Increasing the air pressure results in a more rapid cycling of the pump and thus a higher liquid flow rate. In order to not exceed 120 psig of inlet air pressure, and for accurate control of the pump, it is suggested to use a pressure regulator on the air inlet.

An alternate means of controlling the flow-rate of the pump is to use an inlet air valve and partially open or close accordingly. When the air valve is completely in the closed position, the pump will cease to operate.

A third method of controlling the flow rate of the pump is to use a liquid discharge valve. Closing the liquid discharge valve will cause a decrease in the flow rate since the pump will operate against a higher discharge pressure.

Solenoid control of the inlet air may also be used in order to facilitate remote operation. A three way solenoid valve is recommended, in order to allow the air to “bleed off” between the solenoid and the pump.

Do not use valves for flow control on the suction side of the pump. (Closing or partially closing a liquid suction valve restrict the suction line and may cause damage to the diaphragms.) Suction strainers may be employed to reduce or eliminate larger solids, but routine maintenance is necessary in order to prevent a restriction on the suction.

MAINTENANCE

Due to the unique nature of each application, periodic inspection of the pump is the best method to determine a proper maintenance schedule. A record should be kept of all repairs made to an installed pump. This will serve as the best predictor of future maintenance.

Typical maintenance involves replacing of “wear-parts” such as the diaphragms, balls, valve seats and O-rings. Proper maintenance can ensure trouble-free operation of the pump. Refer to repair and assembly instructions for further details.

 **WARNING** Maintenance must not be performed when a hazardous atmosphere is present.

MAINTENANCE SCHEDULE

WEEKLY (OR DAILY)

Make a visual check of the pump. If pumped fluid is leaking out of the pump, pipe fittings or muffler turn off pump and schedule maintenance.

EVERY THREE MONTHS

Inspect fasteners and tighten any loose fasteners to recommended torque settings.

Schedule pump service based on pump’s service history.

REPAIR AND ASSEMBLY

PUMP WET END REMOVAL

TOOLS NEEDED

- 1) Two Wrenches, 9/16 Inch
- 2) Two Wrenches, 1 Inch
- 3) One Socket Wrench, 1-1/16 Inch
- 4) One Flat (Spanner) Wrench, 3/4 Inch (May Be Required)

⚠ WARNING Prior to servicing the pump, ensure that the air and fluid lines are closed and disconnected. While wearing personal protective equipment, flush, drain and process liquid from the pump in a safe manner.

⚠ WARNING Maintenance must not be performed when a hazardous atmosphere is present.



STEP 1

Using the 9/16 inch wrench remove four "Hex-Head Cap Screws (3/8"-16x1-3/4)", four "Flat & Lock Washers (3/8)" and four "Flanged Hex Nuts (3/8"-16)" from the "Discharge Manifold".



STEP 2

Remove the "Discharge Manifold".

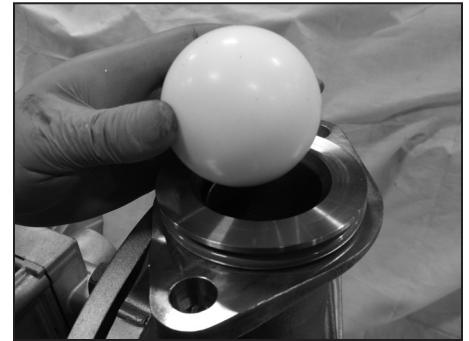

STEP 3

Remove the "O-Ring", "Valve Seat" and "Ball" from the "Discharge Manifold".

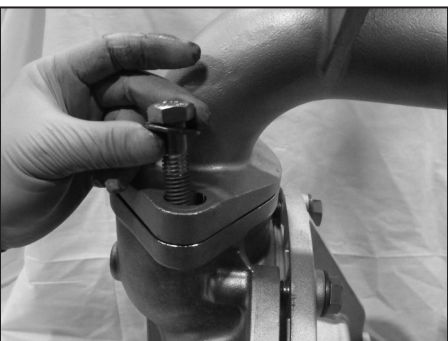

STEP 4

Using the 9/16 inch wrench remove four "Hex-Head Cap Screws (3/8"-16x1-3/4)", four "Flat & Lock Washers (3/8)" and four "Flanged Hex Nuts (3/8"-16)" from the "Suction Manifold".



STEP 5

Remove the "Suction Manifold".



STEP 6

Remove the "O-Ring", "Valve Seat" and "Ball" from the "Suction Manifold".

**STEP 7**

In order to remove both "Outer Chambers" use two 9/16 inch wrenches. Remove ten "Hex-Head Cap Screws (3/8"-16x1-3/4)", ten "Flat & Lock Washers (3/8)" and ten "Flanged Hex Nut (3/8"-16)" from each "Outer Chamber". (Air ratchet may also be used as shown in image)

**STEP 8**

Remove both "Outer Chambers" from the "Intermediate."

**STEP 9**

Using two 1 inch wrenches, remove "Outer Diaphragm Plate", "Diaphragm", "Inner Diaphragm Plate" and "Nut" from one side of the pump.

Flat 3/4" wrench may be used on flat of diaphragm rod to assist in diaphragm removal.

**STEP 10**

Placing the 1 inch wrench on the "Outer Diaphragm Plate", and the 1 1/16 inch socket on the "Nut", remove the "Inner Diaphragm Plate".

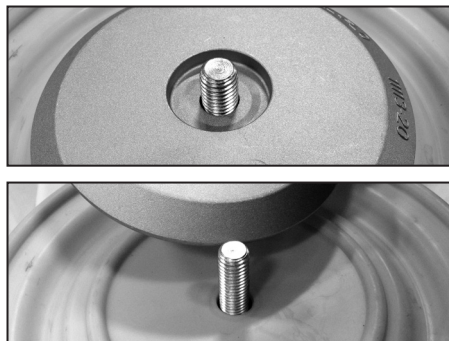
**STEP 11**

Remove "Inner Diaphragm Plate" and "Outer Diaphragm Plate" from "Diaphragm."

PUMP WET END ASSEMBLY

To assemble the wet end of the pump, reverse the order of disassembly. Ensure all hardware is fastened in accordance with torque specifications [see page 21]. Inverting one of the diaphragms during reassembly will facilitate ease of assembly.

REPAIR AND ASSEMBLY

AIR VALVE REMOVAL

TOOLS NEEDED

- 1) One Wrench, 7/16 Inch
- 2) One Pick, General Purpose
- 3) One Pair of Pliers

⚠ WARNING Prior to servicing the pump, ensure that the air and fluid lines are closed and disconnected. While wearing personal protective equipment, flush, drain and process liquid from the pump in a safe manner.

⚠ WARNING Maintenance must not be performed when a hazardous atmosphere is present.



STEP 1

Using the $\frac{7}{16}$ inch wrench, remove four "Hex Head Cap Screws (1/4"-20 x 3")", four "Lock Washers (1/4)" and four "Flat Washers (1/4)".

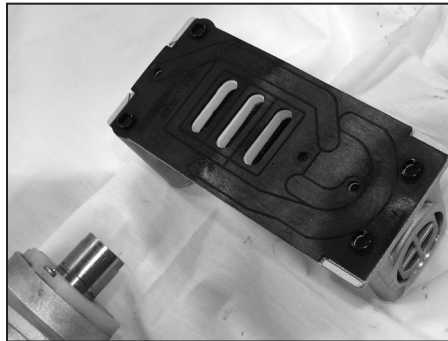

STEP 2

Remove the main "Air-Valve Assembly" from the pump.

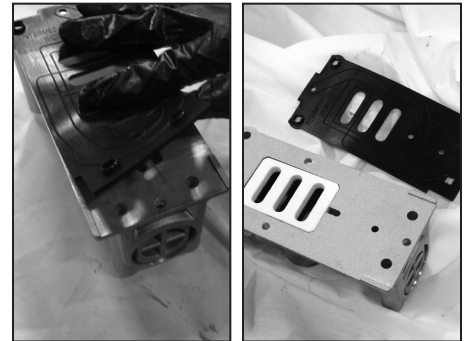

STEP 3

Remove the "Air-Valve Gasket" from the main "Air-Valve Assembly".



STEP 4

Remove the "Shuttle Plate" from the main "Air-Valve Assembly".

Note: The smooth shiny side of the shuttle plate should be toward the shuttle car.



STEP 5

Remove the "Shuttle" from the main "Air-Valve Assembly".



STEP 6

Using the pair of pliers, remove the "Air Valve End Plug" from the main "Air-Valve Assembly".

Ensure the "O-Ring" is installed when reassembling.

**STEP 7**

Remove the "Air Valve Spool" from the main "Air-Valve Assembly".

Note: The longer piston is to be on the plug side.

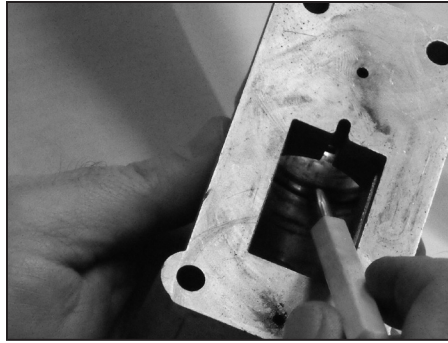
**STEP 8**

Using the pick, remove the "Lip Seal (Air Valve)" from the main "Air-Valve Assembly".

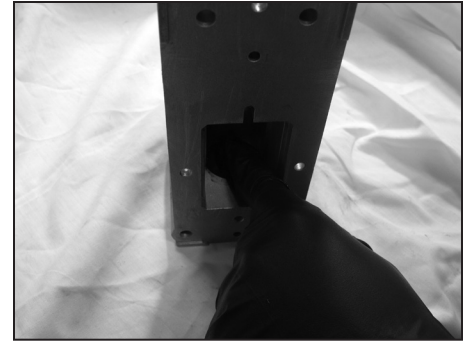
**STEP 9**

Using the pick, remove the second "Lip Seal (Air Valve)" from the main "Air-Valve Assembly".

AIR VALVE ASSEMBLY

To assemble the air valve, reverse the order of disassembly. During assembly, ensure that the open side of the lip-seals are both facing each other inward. Install the shuttle plate with the smooth/shiny side toward the shuttle car. Lubrication of the air valve assembly, with a non-synthetic lubricant, is recommended. Magna-Lube or Magna-Plate are recommended for assembly lubrication (see detailed parts list for ordering information).

Note that if the lip-seals are installed incorrectly, they will be unable to rotate. Insert the spool, the spool's longer piston is to be on the plug side, ensure O-ring is installed, and then the air-valve end plug into position.

REPAIR AND ASSEMBLY

PILOT VALVE REMOVAL

TOOLS NEEDED

- 1) One Screwdriver, Phillips #2
- 2) Two Wrenches, 3/4 Inch

The chambers do not need to be removed for this procedure. The graphics show the inner chambers removed for clarity.

⚠ WARNING Prior to servicing the pump, ensure that the air and fluid lines are closed and disconnected. While wearing personal protective equipment, flush, drain and process liquid from the pump in a safe manner.

⚠ WARNING Maintenance must not be performed when a hazardous atmosphere is present.

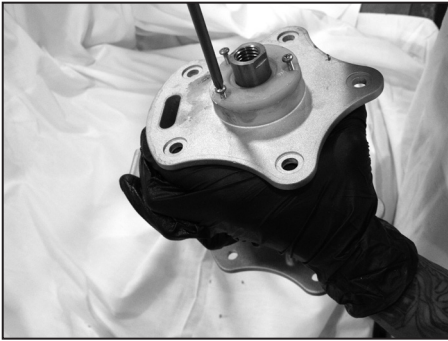

STEP 1

Using the screwdriver, remove three "Phillips Pan Head Mach Screw (#6-32-x 3/8)" in order to remove the "Retaining Plate". Repeat for both sides of the pump.

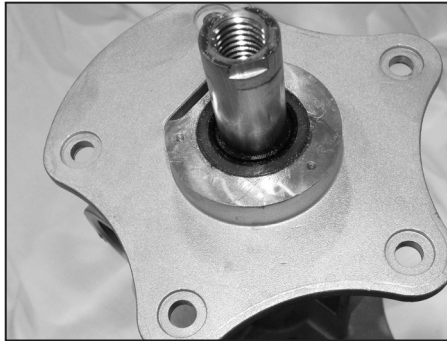

STEP 2

Remove the "Diaphragm Rod" and the "Pilot Sleeve Assembly" from the "Intermediate".



STEP 3

Remove the "Lip Seal" and "End Spacer".



STEP 4

Remove "O-Rings" and "Inner Spacer".

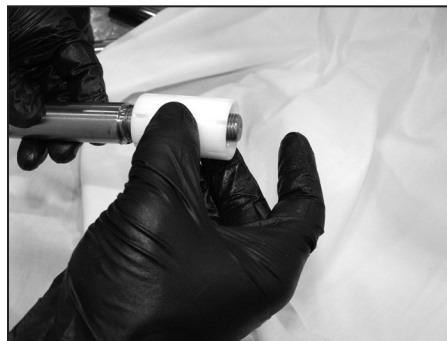

STEP 5

Remove "Pilot Sleeve" from diaphragm rod. The two piece rod must be disassembled to remove the "pilot sleeve". Use the 3/4 inch wrenches to separate the rod. Note they are installed with thread locker.

PILOT VALVE ASSEMBLY

To assemble the pilot valve, reverse the order of disassembly. Should process fluid have contact with the pilot valve O-rings, they should be replaced as swelling may occur and cause irregular operation. During assembly, ensure that the open side of the lip-seals are facing outward. Lubrication of the pilot sleeve assembly, with a non-synthetic lubricant, is recommended in order to facilitate re-assembly into the intermediate. Magna-Lube or Magna-Plate are recommended for assembly lubrication [see detailed parts list for ordering information].

TORQUE SPECIFICATION CHART

RECOMMENDED TORQUE SPECIFICATIONS

	1-1/2" Pumps	Wrench Size
Manifold Bolts	30 ft-lbs (40.7 N-m)	9/16"
Chamber Bolts	15 ft-lbs (20.3 N-m)	9/16"
Air Valve Bolts	40 in-lbs (4.5 N-m)	7/16"
Inner Diaphragm Plate Nut	50 ft-lbs (67.8 N-m)	1 - 1/16"
Intermediate Bolts	11 ft-lbs (14.9 N-m)	1/2"
Outer Diaphragm Plate	Hand tight then 1/8 to 1/4 turn more	

EXPLODED VIEW & PARTS LIST

THREADED ALUMINUM & STAINLESS STEEL

FULL STROKE, A150-***-****-***

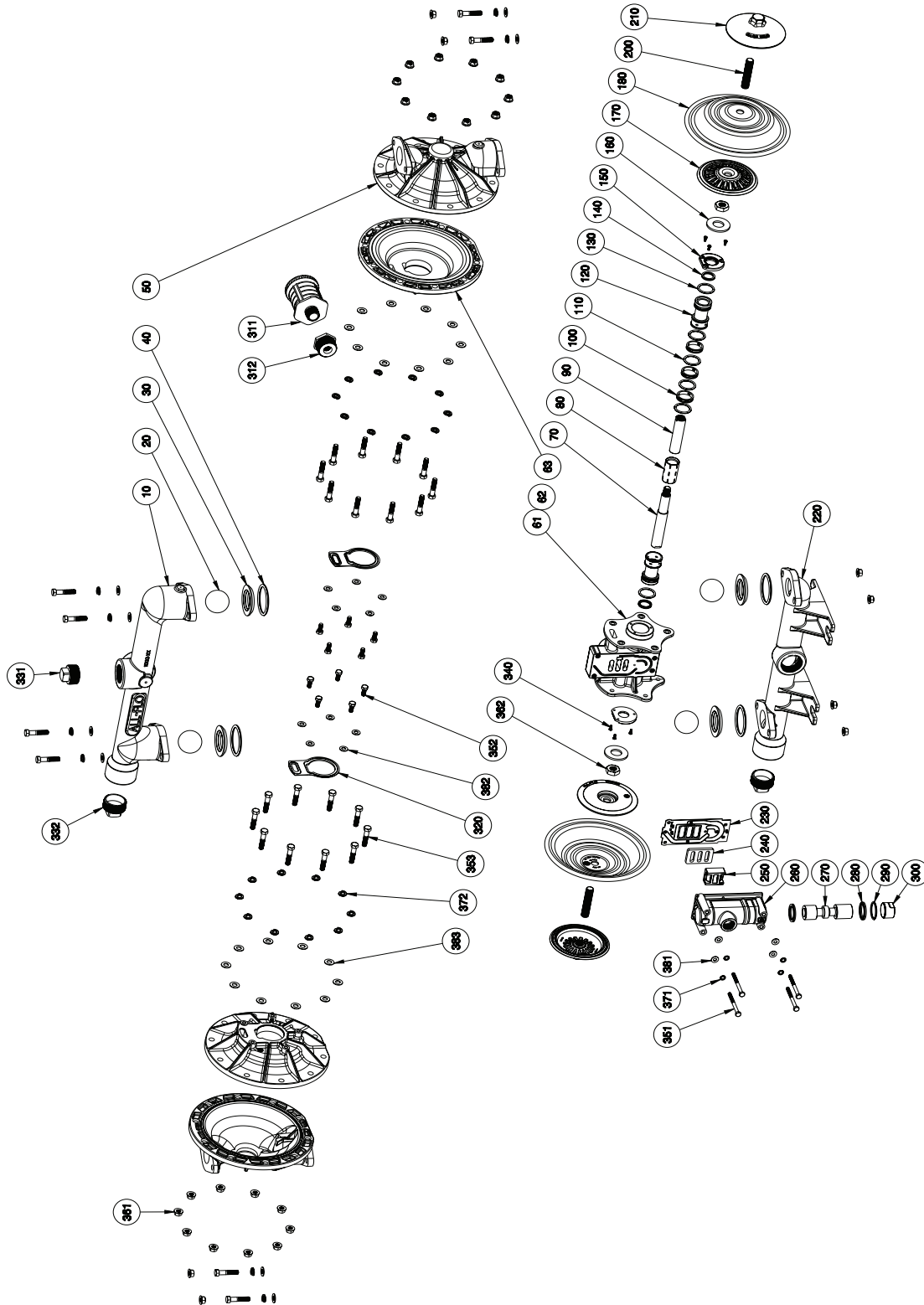

PARTS LIST - THREADED ALUMINUM & STAINLESS STEEL

FULL STROKE, A150-***-****-***

ITEM	DESCRIPTION	QTY	PUMP MODEL	PART NO.	MATERIAL
10	DISCHARGE MANIFOLD - THREADED	1	A150-N*A-****-***	11332-20-NPT	Aluminum
			A150-N*3-****-***	11332-26-NPT	Stainless Steel
			A150-B*A-****-***	11332-20-BSPT	Aluminum
			A150-B*3-****-***	11332-26-BSPT	Stainless Steel
20	BALL	4	A150-***-V**-*	11010-13 †	FKM
			A150-***-E**-*	11010-15 †	EPDM
			A150-***-G**-*	11010-19 †	Geolast®
			A150-***-N**-*	11010-21 †	Buna-N
			A150-***-S**-*	11010-23 †	Santoprene®
			A150-***-T**-*	11010-59 †	PTFE
30	VALVE SEAT	4	A150-***-A*-***	10930-20 †	Aluminum
			A150-***-3*-***	10930-26 †	Stainless Steel
			A150-***-P*-***	10930-39 †	Polypropylene
			A150-***-Y*-***	10930-42 †	Nylon
40	O-RING, VALVE SEAT	4	A150-***-N-***	11952-11 †	Nitrile
			A150-***-V-***	11952-13 †	FKM
			A150-***-E-***	11952-15 †	EPDM
			A150-***-T-***	11952-17 †	PTFE
50	OUTER CHAMBER	2	A150-AA-****-***	10727-20	Aluminum
			A150-33-****-***	10727-26	Stainless Steel
61&62	INTERMEDIATE	1	A150-A*-****-***	11525-20	Aluminum
			A150-33-****-***	11525-26	Stainless Steel
63	INNER CHAMBER	2	A150-A*-****-***	11806-20	Aluminum
			A150-33-****-***	11806-26	Stainless Steel
70&90	DIAPHRAGM ROD ASSEMBLY (FULL STROKE)	1	All non-PTFE Models	35003-00	Stainless Steel
80	VALVE SLEEVE	1	All Models	10107-31 Δ	Acetal
100	INNER SPACER (PILOT SLEEVE)	3	All Models	10205-40 Δ	Polypropylene
110	O-RING (PILOT SLEEVE)	4	All Models	11919-16 Δ	Urethane
120	END SPACER (PILOT SLEEVE)	2	All Models	10208-40 Δ	Polypropylene
130	O-RING (END SPACER)	2	All Models	11919-11 Δ	Nitrile
140	LIP SEAL (DIAPHRAGM ROD)	2	All Models	12002-76 Δ	Nitrile
150	RETAINING PLATE	2	All Models	12717-54	Nylon
160	BUMPER	2	All Models	12317-16	Urethane
170	INNER DIAPHRAGM PLATE (FULL STROKE) (NON-PTFE MODELS)	2	A150-A*-****-***	11112-20	Aluminum
			A150-33-****-***	11112-26	Stainless Steel
180	DIAPHRAGM	2	A150-***-N**-*	10614-11 †	Buna-N
			A150-***-V**-*	10614-13 †	FKM
			A150-***-E**-*	10614-15 †	EPDM
			A150-***-G**-*	10614-19 †	Geolast®
			A150-***-S**-*	10614-23 †	Santoprene®
190	N/A				
200&210	OUTER DIAPHRAGM PLATE WITH STUD	2	A150-AA-****-***	11221-20	Aluminum
			A150-33-****-***	11221-26	Stainless Steel
220	SUCTION MANIFOLD - THREADED	1	A150-N*A-****-***	11333-20-NPT	Aluminum
			A150-N*3-****-***	11333-26-NPT	Stainless Steel
			A150-B*A-****-***	11333-20-BSPT	Aluminum
			A150-B*3-****-***	11333-26-BSPT	Stainless Steel
230	AIR VALVE GASKET	1	All Models	12124-19 ‡	Nitrile
240	SHUTTLE PLATE	1	All Models	10450-77 ‡	Ceramic
250	SHUTTLE	1	All Models	10430-00 ‡	Special

PARTS LIST - THREADED ALUMINUM & STAINLESS STEEL

FULL STROKE, A150-***-****-***

ITEM	DESCRIPTION	QTY	PUMP MODEL	PART NO.	MATERIAL
260	AIR VALVE BODY	1	A150-*A*-****-*** A150-*33*-****-***	11618-20 ‡ 11618-26 ‡	Aluminum Stainless Steel
270	AIR VALVE SPOOL	1	All Models	10483-31 ‡	Acetal
280	LIP SEAL (AIR VALVE)	2	All Models	12003-76 ‡	Nitrile
290	O-RING (AIR VALVE END PLUG)	1	All Models	11913-11 ‡	Nitrile
300	AIR VALVE END PLUG	1	A150-*A*-****-*** A150-*33*-****-***	11706-20 ‡ 11706-26 ‡	Aluminum Stainless Steel
311&312	MUFFLER w/ BUSHING	1	A150-***-****-*0* Optional	13013-00 13010-00	Polypropylene Metal
320	INNER CHAMBER GASKET	2	All Models	12123-19	Nitrile
331	PIPE PLUG 1-1/4"	1	A150-B*A*-****-*** A150-N*A*-****-*** A150-B*3-****-*** A150-N*3-****-***	12275-20-BSPT 12275-20-NPT 12275-26-BSPT 12275-26-NPT	Aluminum Aluminum Stainless Steel Stainless Steel
332	PIPE PLUG 1-1/2"	1	A150-B*A*-****-*** A150-N*A*-****-*** A150-B*3-****-*** A150-N*3-****-***	12270-20-BSPT 12270-20-NPT 12270-26-BSPT 12270-26-NPT	Aluminum Aluminum Stainless Steel Stainless Steel
340	SCREW, SELF-LOCKING PHILLIPS (#6-32 X 3/8")	6	All Models	12571-26	Stainless Steel
351	SCREW ,HEX HEAD CAP (1/4" -20 X 3")	4	A150-**A*-****-*0* A150-**3-****-*0*	12516-25 12516-26	Plated Steel Stainless Steel
352	SCREW, HEX HEAD CAP (5/16" -18 X 3/4")	10	A150-**A*-****-*0* A150-**3-****-*0*	12536-25 12536-26	Plated Steel Stainless Steel
353	SCREW, HEX HEAD CAP (3/8" -16 X 1-3/4")	28	A150-**A*-****-*0* A150-**3-****-*0*	12581-25 12581-26	Plated Steel Stainless Steel
361	NUT, FLANGE (3/8"-16)	28	A150-**A*-****-*0* A150-**3-****-*0*	12612-25 12612-26	Plated Steel Stainless Steel
362	NUT (5/8"-11)	2	All Models	12579-25	Plated Steel
371	WASHER, LOCK (1/4")	4	A150-**A*-****-*0* A150-**3-****-*0*	12350-25 12350-26	Plated Steel Stainless Steel
372	WASHER, SPLIT LOCK (3/8")	28	A150-**A*-****-*0* A150-**3-****-*0*	12316-25 12316-26	Plated Steel Stainless Steel
381	WASHER, FLAT (1/4")	4	A150-**A*-****-*0* A150-**3-****-*0*	12300-25 12300-26	Plated Steel Stainless Steel
382	WASHER (5/16")	10	A150-**A*-****-*0* A150-**3-****-*0*	12310-25 12310-26	Plated Steel Stainless Steel
383	WASHER (3/8")	28	A150-**A*-****-*0* A150-**3-****-*0*	12303-25 12303-26	Plated Steel Stainless Steel
390	N/A				
400	GROUNDING LUG (NOT SHOWN)	1	Optional	13481-20	Aluminum
	Magnalube .75 OZ.		As Required, All Models	13404-00	Grease

* Any Character

‡ , Δ Only sold as part of assembly

ASSEMBLY PART NUMBERS	PUMP MODEL	PART NO.	MATERIAL
‡ MAIN AIR VALVE ASSEMBLY 230, 240, 250, 260, 270, 280, 290, 300	A150-*A*-****-*** A150-*33*-****-***	AMK-150-A AMK-150-3	Various Various
Δ PILOT VALVE ASSEMBLY 80, 100, 110, 120, 130, 140	A150-*A*-****-*** A150-*33*-****-***	APK-150-A APK-150-3	Various Various
† WET END REPAIR KIT 20, 30, 40, 180, 190	A150-*A*-****-***	AWE-150-****-M	Various

PARTS LIST - THREADED ALUMINUM & STAINLESS STEEL

PTFE SHORT STROKE, A150-***-T***-***

ITEM	DESCRIPTION	QTY	PUMP MODEL	PART NO.	MATERIAL
10	DISCHARGE MANIFOLD - THREADED	1	A150-N*A-****-***	11332-20-NPT	Aluminum
			A150-N*3-****-***	11332-26-NPT	Stainless Steel
			A150-B*A-****-***	11332-20-BSPT	Aluminum
			A150-B*3-****-***	11332-26-BSPT	Stainless Steel
20	BALL	4	A150-***V***	11010-13 †	FKM
			A150-***E***	11010-15 †	EPDM
			A150-***G***	11010-19 †	Geolast®
			A150-***N***	11010-21 †	Buna-N
			A150-***S***	11010-23 †	Santoprene®
			A150-***T***	11010-59 †	PTFE
30	VALVE SEAT	4	A150-***A*-***	10930-20 †	Aluminum
			A150-***3*-***	10930-26 †	Stainless Steel
			A150-***P*-***	10930-39 †	Polypropylene
			A150-***Y*-***	10930-42 †	Nylon
40	O-RING, VALVE SEAT	4	A150-***N-***	11952-11 †	Nitrile
			A150-***V-***	11952-13 †	FKM
			A150-***E-***	11952-15 †	EPDM
			A150-***T-***	11952-17 †	PTFE
50	OUTER CHAMBER	2	A150-AA-****-***	10727-20	Aluminum
			A150-33-****-***	10727-26	Stainless Steel
61&62	INTERMEDIATE	1	A150-A*-****-***	11525-20	Aluminum
			A150-33-****-***	11525-26	Stainless Steel
63	INNER CHAMBER	2	A150-A*-****-***	11806-20	Aluminum
			A150-33-****-***	11806-26	Stainless Steel
70&90	DIAPHRAGM ROD ASSEMBLY (SHORT STROKE)	1	A150-***T***-***	35004-00	Stainless Steel
80	VALVE SLEEVE	1	All Models	10107-31 Δ	Acetal
100	INNER SPACER (PILOT SLEEVE)	3	All Models	10205-40 Δ	Polypropylene
110	O-RING (PILOT SLEEVE)	4	All Models	11919-16 Δ	Urethane
120	END SPACER (PILOT SLEEVE)	2	All Models	10208-40 Δ	Polypropylene
130	O-RING (END SPACER)	2	All Models	11919-11 Δ	Nitrile
140	LIP SEAL (DIAPHRAGM ROD)	2	All Models	12002-76 Δ	Nitrile
150	RETAINING PLATE	2	All Models	12717-54	Nylon
160	BUMPER	2	All Models	12317-16	Urethane
170	INNER DIAPHRAGM PLATE (SHORT STROKE) (PTFE PUMP MODELS)	2	A150-A*-T***-***	11114-20	Aluminum
			A150-33-T***-***	11114-26	Stainless Steel
180	DIAPHRAGM (BACKUP)	2	A150-***S***-***	10615-23 †	Santoprene®
190	OVERLAY (DIAPHRAGM)	2	A150-***T***-***	11410-59 †	PTFE
200&210	OUTER DIAPHRAGM PLATE WITH STUD	2	A150-AA-****-***	11221-20	Aluminum
			A150-33-****-***	11221-26	Stainless Steel
220	SUCTION MANIFOLD - THREADED	1	A150-N*A-****-***	11333-20-NPT	Aluminum
			A150-N*3-****-***	11333-26-NPT	Stainless Steel
			A150-B*A-****-***	11333-20-BSPT	Aluminum
			A150-B*3-****-***	11333-26-BSPT	Stainless Steel
230	AIR VALVE GASKET	1	All Models	12124-19 ‡	Nitrile
240	SHUTTLE PLATE	1	All Models	10450-77 ‡	Ceramic
250	SHUTTLE	1	All Models	10430-00 ‡	Special
260	AIR VALVE BODY	1	A150-A*-****-***	11618-20 ‡	Aluminum
			A150-33-****-***	11618-26 ‡	Stainless Steel
270	AIR VALVE SPOOL	1	All Models	10483-31 ‡	Acetal

PARTS LIST - THREADED ALUMINUM & STAINLESS STEEL

PTFE SHORT STROKE, A150-***-T***-***

ITEM	DESCRIPTION	QTY	PUMP MODEL	PART NO.	MATERIAL
280	LIP SEAL (AIR VALVE)	2	All Models	12003-76 ‡	Nitrile
290	O-RING (AIR VALVE END PLUG)	1	All Models	11913-11 ‡	Nitrile
300	AIR VALVE END PLUG	1	A150-*A*-****-*** A150-*33-****-***	11706-20 ‡ 11706-26 ‡	Aluminum Stainless Steel
311&312	MUFFLER w/ BUSHING	1	A150-***-****-*0* Optional	13013-00 13010-00	Polypropylene Metal
320	INNER CHAMBER GASKET	2	All Models	12123-19	Nitrile
331	PIPE PLUG 1-1/4"	1	A150-B*A*-****-*** A150-N*A*-****-*** A150-B*3-****-*** A150-N*3-****-***	12275-20-BSPT 12275-20-NPT 12275-26-BSPT 12275-26-NPT	Aluminum Aluminum Stainless Steel Stainless Steel
332	PIPE PLUG 1-1/2"	1	A150-B*A*-****-*** A150-N*A*-****-*** A150-B*3-****-*** A150-N*3-****-***	12270-20-BSPT 12270-20-NPT 12270-26-BSPT 12270-26-NPT	Aluminum Aluminum Stainless Steel Stainless Steel
340	SCREW, SELF-LOCKING PHILLIPS (#6-32 X 3/8")	6	All Models	12571-26	Stainless Steel
351	SCREW, HEX HEAD CAP (1/4"-20 X 3")	4	A150-**A-****-*0* A150-***3-****-*0*	12516-25 12516-26	Plated Steel Stainless Steel
352	SCREW, HEX HEAD CAP (5/16"-18 X 3/4")	10	A150-**A-****-*0* A150-***3-****-*0*	12536-25 12536-26	Plated Steel Stainless Steel
353	SCREW, HEX HEAD CAP (3/8"-16 X 1-3/4")	28	A150-**A-****-*0* A150-***3-****-*0*	12581-25 12581-26	Plated Steel Stainless Steel
361	NUT, FLANGE (3/8"-16)	28	A150-**A-****-*0* A150-***3-****-*0*	12612-25 12612-26	Plated Steel Stainless Steel
362	NUT (5/8"-11)	2	All Models	12579-25	Plated Steel
371	WASHER, LOCK (1/4")	4	A150-**A-****-*0* A150-***3-****-*0*	12350-25 12350-26	Plated Steel Stainless Steel
372	WASHER, SPLIT LOCK (3/8")	28	A150-**A-****-*0* A150-***3-****-*0*	12316-25 12316-26	Plated Steel Stainless Steel
381	WASHER, FLAT (1/4")	4	A150-**A-****-*0* A150-***3-****-*0*	12300-25 12300-26	Plated Steel Stainless Steel
382	FLAT WASHER, (5/16")	10	A150-**A-****-*0* A150-***3-****-*0*	12310-25 12310-26	Plated Steel Stainless Steel
383	WASHER (3/8")	28	A150-**A-****-*0* A150-***3-****-*0*	12303-25 12303-26	Plated Steel Stainless Steel
390	N/A				
400	GROUNDING LUG (NOT SHOWN)	1	Optional	13481-20	Aluminum
	Magnalube .75 OZ.		As Required, All Models	13404-00	Grease

* Any Character

‡, Δ Only sold as part of assembly

‡ MAIN AIR VALVE ASSEMBLY
230, 240, 250, 260, 270, 280, 290, 300

A150-*A*-****-***
A150-*33-****-***

AMK-150-A
AMK-150-3

Various
Various

ASSEMBLY PART NUMBERS
80, 100, 110, 120, 130, 140

PUMP MODEL
A150-*33-****-***

PART NO.
APK-150-3

Various
Various

† WET END REPAIR KIT
20, 30, 40, 180, 190

A150-*A*-****-***

AWE-150-****-M

Various

FLANGED STAINLESS STEEL FULL STROKE

A150-F*3-****-***

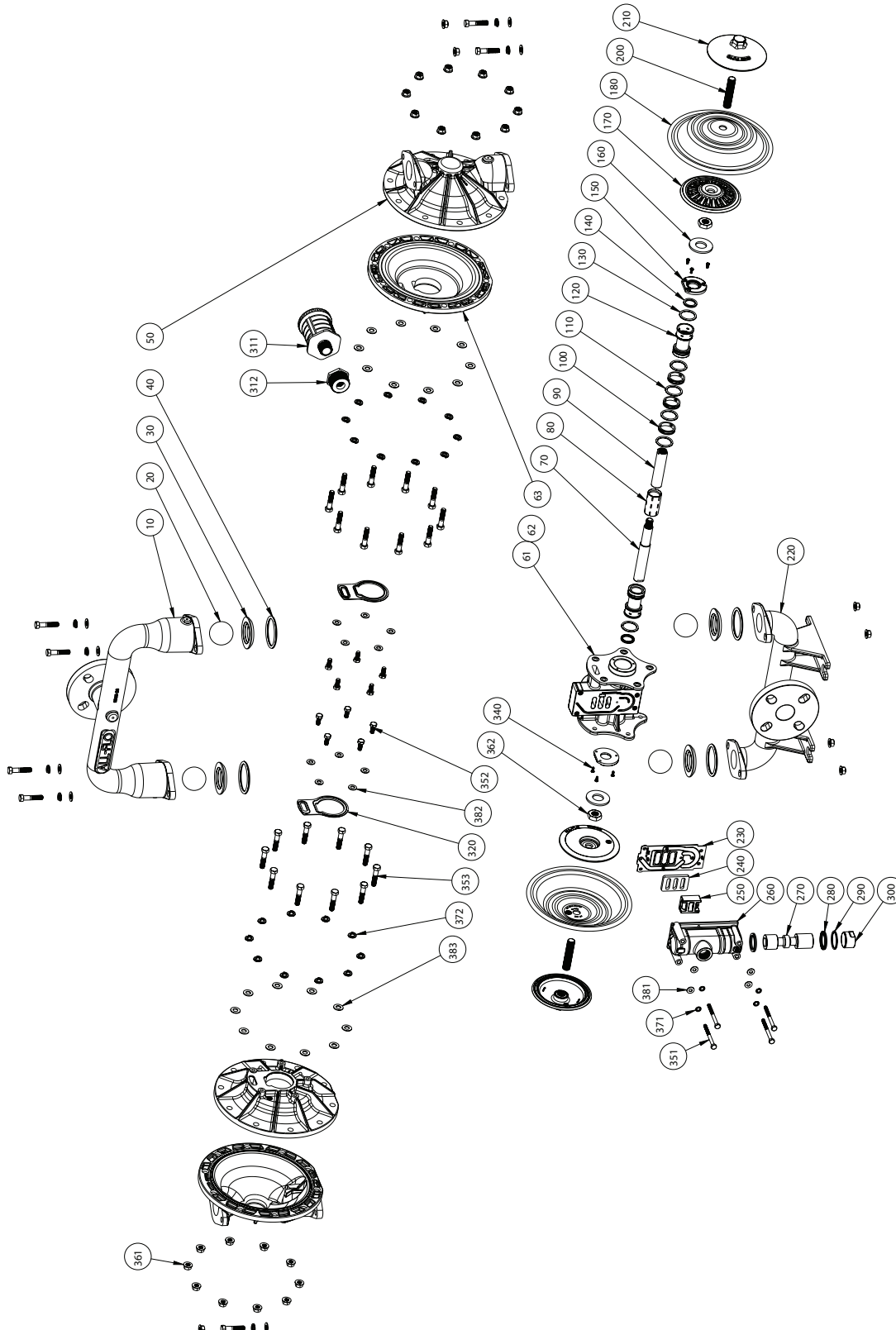

PARTS LIST - FLANGED STAINLESS STEEL FULL STROKE

A150-F*3-****-***

ITEM	DESCRIPTION	QTY	PUMP MODEL	PART NO.	MATERIAL
10	DISCHARGE MANIFOLD - FLANGED	1	A150-F*3-****-***	11336-26	Stainless Steel
20	BALL	4	A150-***-V**_*** A150-***-E**_*** A150-***-G**_*** A150-***-N**_*** A150-***-S**_*** A150-***-T**_***	11010-13 † 11010-15 † 11010-19 † 11010-21 † 11010-23 † 11010-59 †	FKM EPDM Geolast® Buna-N Santoprene® PTFE
30	VALVE SEAT	4	A150-***-**A*_*** A150-***-**3*_*** A150-***-**P*_*** A150-***-**Y*_***	10930-20 † 10930-26 † 10930-39 † 10930-42 †	Aluminum Stainless Steel Polypropylene Nylon
40	O-RING, VALVE SEAT	4	A150-***-***N-*** A150-***-***V-*** A150-***-***E-*** A150-***-***T-***	11952-11 † 11952-13 † 11952-15 † 11952-17 †	Nitrile FKM EPDM PTFE
50	OUTER CHAMBER	2	A150-***3-****-***	10727-26	Stainless Steel
61&62	INTERMEDIATE	1	A150-*A*-****-*** A150-*33-****-***	11525-20 11525-26	Aluminum Stainless Steel
63	INNER CHAMBER	2	A150-*A*-****-*** A150-*33-****-***	11806-20 11806-26	Aluminum Stainless Steel
70&90	DIAPHRAGM ROD ASSEMBLY (FULL STROKE)	1	All non-PTFE Models	35003-00	Stainless Steel
80	VALVE SLEEVE	1	All Models	10107-31 Δ	Acetal
100	INNER SPACER (PILOT SLEEVE)	3	All Models	10205-40 Δ	Polypropylene
110	O-RING (PILOT SLEEVE)	4	All Models	11919-16 Δ	Urethane
120	END SPACER (PILOT SLEEVE)	2	All Models	10208-40 Δ	Polypropylene
130	O-RING (END SPACER)	2	All Models	11919-11 Δ	Nitrile
140	LIP SEAL (DIAPHRAGM ROD)	2	All Models	12002-76 Δ	Nitrile
150	RETAINING PLATE	2	All Models	12717-54	Nylon
160	BUMPER	2	All Models	12317-16	Urethane
170	INNER DIAPHRAGM PLATE (FULL STROKE) (NON-PTFE MODELS)	2	A150-*A*-****-*** A150-*33-****-***	11112-20 11112-26	Aluminum Stainless Steel
180	DIAPHRAGM	2	A150-***-N***_*** A150-***-V***_*** A150-***-E***_*** A150-***-G***_*** A150-***-S***_***	10614-11 † 10614-13 † 10614-15 † 10614-19 † 10614-23 †	Buna-N FKM EPDM Geolast® Santoprene®
190	N/A				
200&210	OUTER DIAPHRAGM PLATE WITH STUD	2	A150-***3-****-***	11221-26	Stainless Steel
220	SUCTION MANIFOLD - FLANGED	1	A150-F*3-****-***	11337-26	Stainless Steel
230	GASKET, AIR VALVE	1	All Models	12124-19 ‡	Nitrile
240	SHUTTLE PLATE	1	All Models	10450-77 ‡	Ceramic
250	SHUTTLE	1	All Models	10430-00 ‡	Special
260	AIR VALVE BODY	1	A150-*A*-****-*** A150-*33-****-***	11618-20 ‡ 11618-26 ‡	Aluminum Stainless Steel
270	AIR VALVE SPOOL	1	All Models	10483-31 ‡	Acetal

PARTS LIST - FLANGED STAINLESS STEEL FULL STROKE

A150-F*3-****-***

ITEM	DESCRIPTION	QTY	PUMP MODEL	PART NO.	MATERIAL
280	LIP SEAL (AIR VALVE)	2	All Models	12003-76 ‡	Nitrile
290	O-RING (AIR VALVE END PLUG)	1	All Models	11913-11 ‡	Nitrile
300	AIR VALVE END PLUG	1	A150-*A*-****-***	11706-20 ‡	Aluminum
			A150-*33-****-***	11706-26 ‡	Stainless Steel
311&312	MUFFLER w/ BUSHING	1	A150-***-****-*0*	13013-00	Polypropylene
			Optional	13010-00	Metal
320	INNER CHAMBER GASKET	2	All Models	12123-19	Nitrile
330	N/A				
340	SCREW, SELF-LOCKING PHILLIPS (#6-32 X 3/8")	6	All Models	12571-26	Stainless Steel
351	SCREW, HEX HEAD CAP (1/4"-20 X 3")	4	A150-***3-****-*0*	12516-26	Stainless Steel
352	SCREW, HEX HEAD CAP (5/16"-18 X 3/4")	10	A150-***3-****-*0*	12536-26	Stainless Steel
353	SCREW, HEX HEAD CAP (3/8"-16 X 1-3/4")	28	A150-***3-****-*0*	12581-26	Stainless Steel
361	NUT, FLANGE (3/8"-16)	28	A150-***3-****-*0*	12612-26	Stainless Steel
362	NUT (5/8"-11)	2	All Models	12579-25	Plated Steel
371	WASHER, LOCK (1/4")	4	A150-***3-****-*0*	12350-26	Stainless Steel
372	WASHER, SPLIT LOCK (3/8")	28	A150-***3-****-*0*	12316-26	Stainless Steel
381	WASHER, FLAT (1/4")	4	A150-***3-****-*0*	12300-26	Stainless Steel
382	FLAT WASHER, (5/16")	10	A150-***3-****-*0*	12310-26	Stainless Steel
383	WASHER (3/8")	28	A150-***3-****-*0*	12303-26	Stainless Steel
390	N/A				
400	GROUNDING LUG (NOT SHOWN)	1	Optional	13481-20	Aluminum
	Magnalube .75 OZ.		As Required, All Models	13404-00	Grease

* Any Character

‡, Δ Only sold as part of assembly

ASSEMBLY PART NUMBERS	PUMP MODEL	PART NO.	MATERIAL
‡ MAIN AIR VALVE ASSEMBLY 230, 240, 250, 260, 270, 280, 290, 300	A150-*A*-****-***	AMK-150-A	Various
	A150-*3*-****-***	AMK-150-3	Various
Δ PILOT VALVE ASSEMBLY 80, 100, 110, 120, 130, 140	A150-*A*-****-***	APK-150-A	Various
	A150-*3*-****-***	APK-150-3	Various
† WET END REPAIR KIT 20, 30, 40, 180, 190	A150-*A*-****-***	AWE-150-****-M	Various

FLANGED STAINLESS STEEL PTFE SHORT STROKE A150-F*3-T***-***

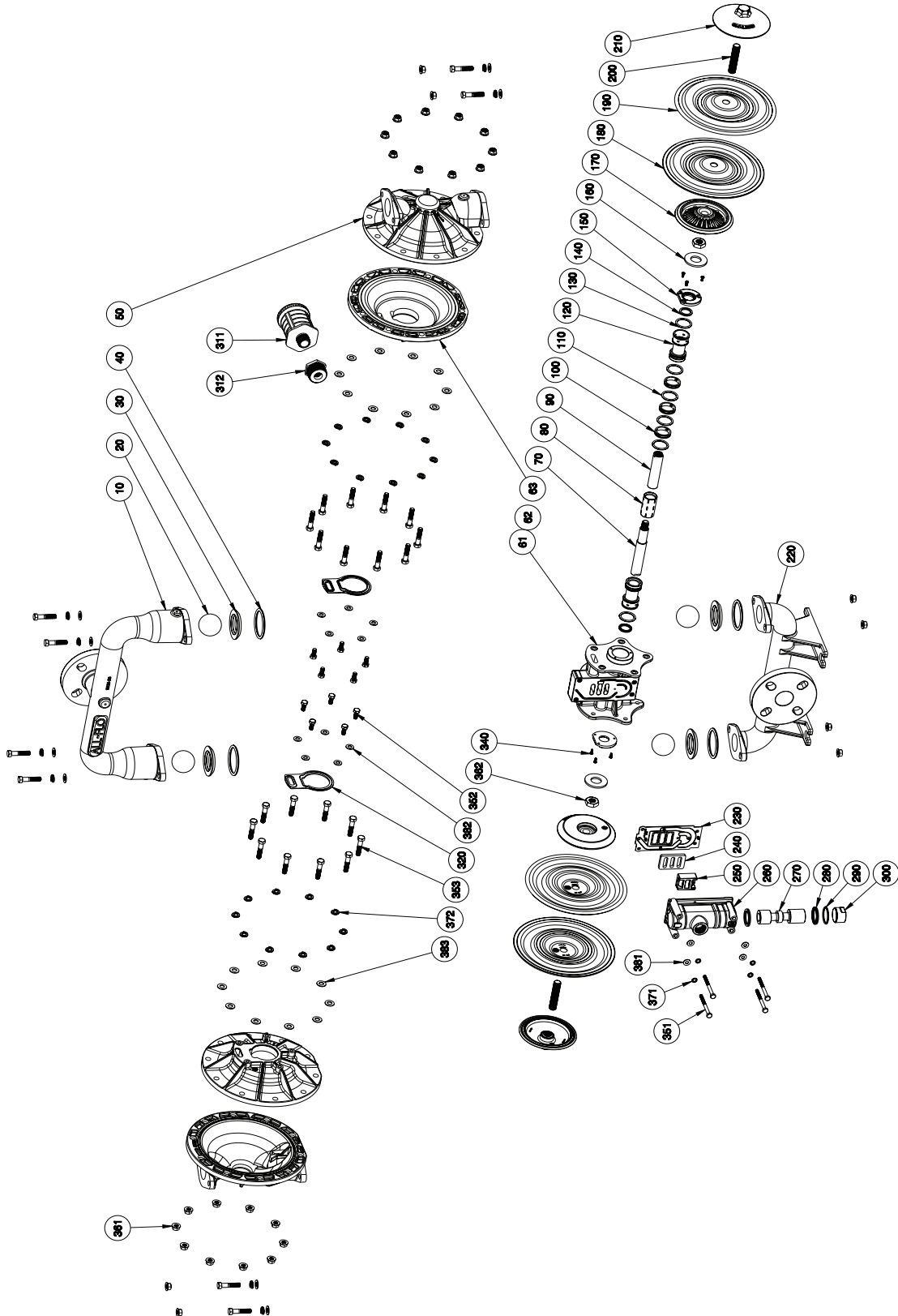

PARTS LIST - FLANGED STAINLESS STEEL SHORT STROKE

A150-F*3-T***-***

ITEM	DESCRIPTION	QTY	PUMP MODEL	PART NO.	MATERIAL
10	DISCHARGE MANIFOLD - FLANGED	1	A150-F*3-****-***	11336-26	Stainless Steel
20	BALL	4	A150-***-V**_*** A150-***-E**_*** A150-***-G**_*** A150-***-N**_*** A150-***-S**_*** A150-***-T**_***	11010-13 † 11010-15 † 11010-19 † 11010-21 † 11010-23 † 11010-59 †	FKM EPDM Geolast® Buna-N Santoprene® PTFE
30	VALVE SEAT	4	A150-***-**A*_*** A150-***-**3*_*** A150-***-**P*_*** A150-***-**Y*_***	10930-20 † 10930-26 † 10930-39 † 10930-42 †	Aluminum Stainless Steel Polypropylene Nylon
40	O-RING, VALVE SEAT	4	A150-***-***N-*** A150-***-***V-*** A150-***-***E-*** A150-***-***T-***	11952-11 † 11952-13 † 11952-15 † 11952-17 †	Nitrile FKM EPDM PTFE
50	OUTER CHAMBER	2	A150-***3-****-***	10727-26	Stainless Steel
61&62	INTERMEDIATE	1	A150-*A*-****-*** A150-*33-****-***	11525-20 11525-26	Aluminum Stainless Steel
63	INNER CHAMBER	2	A150-*AA-****-*** A150-*33-****-***	11806-20 11806-26	Aluminum Stainless Steel
70&90	DIAPHRAGM ROD ASSEMBLY (SHORT STROKE)	1	A150-***-T***-***	35004-00	Stainless Steel
80	VALVE SLEEVE	1	All Models	10107-31 Δ	Acetal
100	INNER SPACER (PILOT SLEEVE)	3	All Models	10205-40 Δ	Polypropylene
110	O-RING (PILOT SLEEVE)	4	All Models	11919-16 Δ	Urethane
120	END SPACER (PILOT SLEEVE)	2	All Models	10208-40 Δ	Polypropylene
130	O-RING (END SPACER)	2	All Models	11919-11 Δ	Nitrile
140	LIP SEAL (DIAPHRAGM ROD)	2	All Models	12002-76 Δ	Nitrile
150	RETAINING PLATE	2	All Models	12717-54	Nylon
160	BUMPER	2	All Models	12317-16	Urethane
170	INNER DIAPHRAGM PLATE (SHORT STROKE) (PTFE MODELS ONLY)	2	A150-*A*-T***-*** A150-*33-T***-***	11114-20 11114-26	Aluminum Stainless Steel
180	DIAPHRAGM (BACKUP)	2	A150-***-S***-***	10615-23 †	Santoprene®
190	OVERLAY (DIAPHRAGM)	2	A150-***-T***-***	11410-59 †	PTFE
200&210	OUTER DIAPHRAGM PLATE WITH STUD	2	A150-***3-****-***	11221-26	Stainless Steel
220	SUCTION MANIFOLD - FLANGED	1	A150-FA3-****-***	11337-26	Stainless Steel
230	GASKET, AIR VALVE	1	All Models	12124-19 ‡	Nitrile
240	SHUTTLE PLATE	1	All Models	10450-77 ‡	Ceramic
250	SHUTTLE	1	All Models	10430-00 ‡	Special
260	AIR VALVE BODY	1	A150-*A*-****-*** A150-*33-****-***	11618-20 ‡ 11618-26 ‡	Aluminum Stainless Steel
270	AIR VALVE SPOOL	1	All Models	10483-31 ‡	Acetal
280	LIP SEAL (AIR VALVE)	2	All Models	12003-76 ‡	Nitrile
290	O-RING (AIR VALVE END PLUG)	1	All Models	11913-11 ‡	Nitrile
300	AIR VALVE END PLUG	1	A150-*A*-****-*** A150-*33-****-***	11706-20 ‡ 11706-26 ‡	Aluminum Stainless Steel
311&312	MUFFLER w/ BUSHING	1	A150-***-****-*0* Optional	13013-00 13010-00	Polypropylene Metal

PARTS LIST - FLANGED STAINLESS STEEL SHORT STROKE

A150-F*3-T***-***

ITEM	DESCRIPTION	QTY	PUMP MODEL	PART NO.	MATERIAL
320	INNER CHAMBER GASKET	2	All Models	12123-19	Nitrile
330	N/A				
340	SCREW, SELF-LOCKING PHILLIPS (#6-32 X 3/8")	6	All Models	12571-26	Stainless Steel
351	SCREW, HEX HEAD CAP (1/4"-20 X 3")	4	A150-***-****-*0*	12516-26	Stainless Steel
352	SCREW, HEX HEAD CAP (5/16"-18 X 3/4")	10	A150-***-****-*0*	12536-26	Stainless Steel
353	SCREW, HEX HEAD CAP (3/8"-16 X 1-3/4")	28	A150-***-****-*0*	12581-26	Stainless Steel
361	NUT, FLANGE (3/8"-16)	28	A150-***-****-*0*	12612-26	Stainless Steel
362	NUT (5/8"-11)	2	All Models	12579-25	Plated Steel
371	WASHER, LOCK (1/4")	4	A150-***-****-*0*	12350-26	Stainless Steel
372	WASHER, SPLIT LOCK (3/8")	28	A150-***-****-*0*	12316-26	Stainless Steel
381	WASHER, FLAT (1/4")	4	A150-***-****-*0*	12300-26	Stainless Steel
382	FLAT WASHER, (5/16")	10	A150-***-****-*0*	12310-26	Stainless Steel
383	WASHER (3/8")	28	A150-***-****-*0*	12303-26	Stainless Steel
390	N/A				
400	GROUNDING LUG (NOT SHOWN)	1	Optional	13481-20	Aluminum
	Magnalube .75 OZ.		As Required, All Models	13404-00	Grease

* Any Character

‡, Δ Only sold as part of assembly

‡ MAIN AIR VALVE ASSEMBLY 230, 240, 250, 260, 270, 280, 290, 300	A150-*A*-****-*** A150-*3*-****-***	AMK-150-A AMK-150-3	Various Various
Δ PILOT VALVE ASSEMBLY 80, 100, 110, 120, 130, 140	A150-*A*-****-*** A150-*3*-****-***	APK-150-A APK-150-3	Various Various
† WET END REPAIR KIT 20, 30, 40, 180, 190	A150-*A*-****-***	AWE-150-****-M	Various

ELASTOMERS

WETTED ELASTOMERS

BUNA-N (NITRILE)

is a general purpose elastomer used with water and many oils. Temperature range 10°F to 180°F (-12°C to 82°C).

GEOLAST®

is an injection molded thermoplastic material with characteristics similar to Nitrile. Has excellent abrasion resistance. Temperature range 10°F to 180°F (-12°C to 82°C).

EPDM

is a general purpose elastomer with good resistance to many acids and bases. Temperature range -40°F to 280°F (-40°C to 138°C).

SANTOPRENE®

is an injection molded material with characteristics similar to EPDM. Has excellent abrasion resistance. Temperature range -40°F to 225°F (-40°C to 107°C).

FKM

is an elastomer with good corrosion resistance to a wide variety of chemicals. Temperature range -40°F to 350°F (-40°C to 177°C).

PTFE (POLYTETRAFLUOROETHYLENE)

is a thermoplastic polymer that is inert to most chemicals. Temperature range 40°F to 220°F (4°C to 104°C).

Most of the above elastomers are available in FDA approved formulations.

Geolast® is a registered trademark of ExxonMobil Chemical Co.
Santoprene® is a registered trademark of ExxonMobil Chemical Co.
Hytrel® is a registered trademark of DuPont Performance Elastomers L.L.C.
Magnalube® is a registered trademark of Carleton-Stuart Corp.



II 2 GD c TX

Warning: The TX marking refers to the maximum surface temperature depending not on the equipment itself, but mainly on operating conditions. In this case, the maximum surface temperature depends upon the temperature of the process fluids.

WARRANTY AND REGISTRATION

WARRANTY. All All-Flo products shall be covered by the standard All-Flo Limited Warranty in effect at the time of shipment. This warranty (which may be modified by All-Flo at any time) provides:

MATERIALS SOLD ARE WARRANTED TO THE ORIGINAL USER AGAINST DEFECTS IN WORKMANSHIP OR MATERIALS UNDER NORMAL USE (RENTAL USE EXCLUDED) FOR FIVE YEARS AFTER PURCHASE DATE. ANY PUMP WHICH IS DETERMINED TO BE DEFECTIVE IN MATERIAL AND WORKMANSHIP AND RETURNED TO ALL-FLO, SHIPPING COSTS PREPAID, WILL BE REPAIRED OR REPLACED AT ALL-FLO'S OPTION. CUSTOMER SHALL NOTIFY ALL-FLO IN WRITING WITHIN 30 DAYS OF ANY CLAIMED DEFECTS. NO MATERIALS CAN BE RETURNED WITHOUT THE PRIOR CONSENT OF ALL-FLO, AND IF APPROVED SHALL BE RETURNED TO ALL-FLO FREIGHT PREPAID. ALL-FLO'S LIABILITY FOR ANY BREACH OF THIS WARRANTY SHALL BE LIMITED TO EITHER REPLACEMENT OF THE MATERIALS OR, AT ALL-FLO'S SOLE OPTION, THE REFUND OF THE PURCHASE PRICE. ALL-FLO SHALL NOT BE HELD LIABLE FOR ANY INCIDENTAL OR CONSEQUENTIAL DAMAGES CAUSED BY BREACH OF THIS WARRANTY. THIS EXCLUSION APPLIES WHETHER SUCH DAMAGES WERE SOUGHT BASED ON BREACH OF WARRANTY, BREACH OF CONTRACT, NEGLIGENCE, STRICT LIABILITY IN TORT, OR ANY OTHER LEGAL THEORY. FURTHER, ALL-FLO SHALL NOT BE LIABLE FOR LOSSES, DELAYS, LABOR COSTS, OR ANY OTHER COST OR EXPENSE DIRECTLY OR INDIRECTLY ARISING FROM THE USE OF MATERIALS. ALL-FLO'S LIABILITY IS EXPRESSLY LIMITED TO THE REPLACEMENT OR REPAIR OF DEFECTIVE GOODS, OR THE TOTAL VALUE OF SUCH GOODS. THIS WARRANTY IS IN LIEU OF ALL OTHER WARRANTIES, WHETHER EXPRESS, IMPLIED, OR ORAL INCLUDING THE IMPLIED WARRANTY OF MERCHANTABILITY, ANY IMPLIED WARRANTY OF FITNESS FOR A PARTICULAR PURPOSE, AND ANY IMPLIED WARRANTIES OTHERWISE ARISING FROM A COURSE OF DEALING OR TRADE. All-Flo will not, in ANY event, be liable for any loss of profit, interruption of business or any other special, consequential or incidental damages suffered or sustained by Customer. All-Flo's total maximum liability to the customer in respect of sale of materials or services rendered by All-Flo is limited to the total monies received by All-Flo from the customer for the particular materials described in Customer's order.

All-Flo does not warrant any part or component that it does not manufacture, but will assign to the original end-user purchaser of any warranty received by it from the manufacturer, to extent such pass through is permitted by the manufacturer



REGISTRATION FORM

Pump Model _____ Pump Serial Number _____

Company Name _____

Name _____ Email _____

Phone # _____ City _____ State _____ Zip _____

Qty of Pumps _____ Fluid Pumping _____

How did you hear about us? Existing All-Flo user,
Web, Distributor, Magazine...

MAIL TO: All-Flo | Attn: Product Registration
22069 Van Buren Street, Grand Terrace, CA 92313-5651



Scan QR code and
complete form
on mobile phone
or visit

www.all-flo.com/registration-form.html



PSG

22069 Van Buren Street

Grand Terrace, CA 92313-5651 USA

P: +1 (440) 354-1700 F: +1 (440) 354-9466

all-flo.com

All-Flo is committed to the pursuit of designing and manufacturing the highest quality product available to industry. Since the beginning in 1986, All-Flo engineers have used their extensive knowledge of today's engineered materials, advanced air system logic and manufacturing techniques to develop the superior group of lube-free, air-operated diaphragm pumps found in this catalog. Every pump is performance engineered and quality built to provide trouble-free service under the toughest conditions.



Where Innovation Flows